

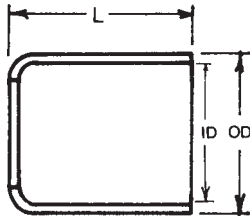

Stems and Ferrules for SAE 100R4 Hose

FERRULE



Part Number	Hose I.D.	-L-	-O.D.-	-I.D.-
612-400	3/4	1.000	1.500	1.375
616-400	1	1.125	1.750	1.625
620-400	1-1/4	1.520	2.000	1.870
624-400	1-1/2	1.560	2.250	2.152
632-400	2	2.000	2.750	2.625

NPTF SOLID MALE STEM

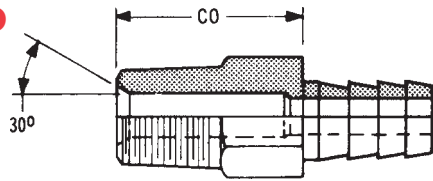

Part Number	Hose I.D.	Thread	Hex	Stem I.D.	Fitting Length	-CO-Cutoff
112-112	3/4	3/4 - 14	1-1/16	.625	2.445	1.125
112-116	3/4	1 - 11-1/2	1-3/8	.625	2.632	1.312
116-116	1	1 - 11-1/2	1-3/8	.843	2.812	1.437
120-120	1-1/4	1-1/4 - 11-1/2	1-3/4	1.062	3.474	1.594
124-124	1-1/2	1-1/2 - 11-1/2	2	1.125	3.710	1.760
132-132	2	2 - 11-1/2	2-1/2	1.687	4.343	1.906

JIC 37° SOLID MALE STEM

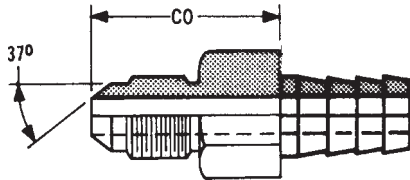

Part Number	Hose I.D.	Thread	Hex	Stem I.D.	Fitting Length	-CO-Cutoff
112-512	3/4	1-1/16 - 12	1-1/16	.625	2.562	1.240
112-514	3/4	1-3/16 - 12	1-1/4	.625	2.562	1.240
112-516	3/4	1-5/16 - 12	1-3/8	.625	2.562	1.240
116-516	1	1-5/16 - 12	1-3/8	.843	2.786	1.410
120-520	1-1/4	1-5/8 - 12	1-3/4	1.062	3.463	1.583

JIC 37° SWIVEL FEMALE STEM

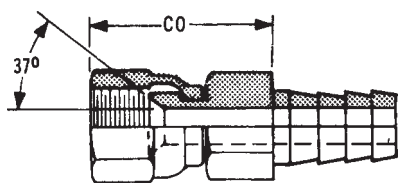

Part Number	Hose I.D.	Thread	Stem Hex	Nut Hex	Stem I.D.	Fitting Length	-CO-Cutoff
112-612	3/4	1-1/16-12	1-1/16	1-1/4	.625	2.640	1.320
112-614	3/4	1-3/16 - 12	1-1/8	1-3/8	.625	2.660	1.340
112-616	3/4	1-5/16 - 12	1-1/4	1-1/2	.625	2.770	1.450
116-616	1	1-5/16 - 12	1-3/8	1-1/2	.843	2.825	1.450
120-620	1-1/4	1-5/8 - 12	1-3/4	2	1.062	3.580	1.700
124-624	1-1/2	1-7/8 - 12	2	2-1/4	1.312	3.980	2.090
132-632	2	2-1/2 - 12	2-1/2	2-7/8	1.687	4.940	2.590

ORB SOLID MALE STEM

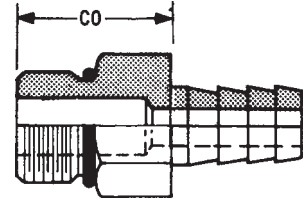

Part Number	Hose I.D.	Thread	Hex	Stem I.D.	Fitting Length	-CO-Cutoff
112-712	3/4	1-1/16 - 12	1-1/4	.625	2.289	.969
116-716	1	1-5/16 - 12	1-1/2	.843	2.469	1.094
120-720	1-1/4	1-5/8 - 12	1-3/4	1.062	3.099	1.219

"O" RING FLANGE-STRAIGHT

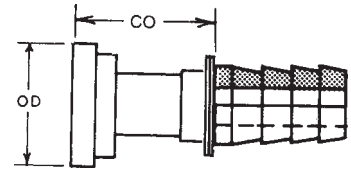

Part Number	Hose I.D.	Flange Size	Flange OD.	Fitting Length	-CO-Cutoff
112-G12	3/4	3/4	1-1/2	3.071	1.779
116-G16	1	1	1-3/4	3.170	1.795
120-G20	1-1/4	1-1/4	2	3.750	1.870
124-G24	1-1/2	1-1/2	2-3/8	3.817	1.950
132-G32	2	2	2-13/16	4.637	2.200

"O" RING FLANGE-45°

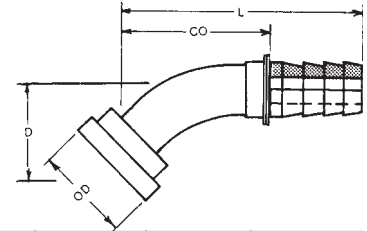

Part Number	Hose I.D.	Flange Size	Flange OD.	Fitting Length	-CO-Cutoff
124-G54	1-1/2	1-1/2	2-3/8	4.750	2.800
132-G62	2	2	2-13/16	9.437	7.000
140-G62	2-1/2	2	2-13/16	9.437	7.000

"O" RING FLANGE-90°

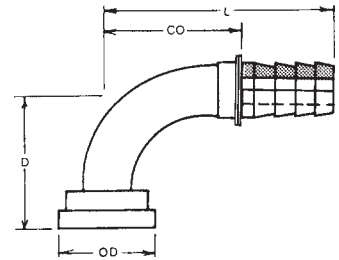

Part Number	Hose I.D.	Flange Size	Flange O.D.	-D-Drop	Fitting Length	-CO-Cutoff
120-G80	1-1/4	1-1/4	2	2.690	5.840	3.921
124-G80	1-1/2	1-1/4	2	2.690	4.298	2.348
124-G84	1-1/2	1-1/2	2-3/8	3.120	6.758	4.808
124-G92	1-1/2	2	2-13/16	2.900	4.760	2.810
132-G92	2	2	2-13/16	4.500	9.586	6.402
132-G96	2	2-1/2	3-5/16	4.620	6.667	4.230
140-G92	2-1/2	2	2-13/16	3.750	6.167	3.730

Ferrules for SAE 100R1, 100R1AT, 100R2, 100R2AT, 100R3, 100R4, 100R5, Hydra-Lite I & II



1 & 2 WIRE COMBINATION STEEL FERRULE-SKIVE REQUIRED

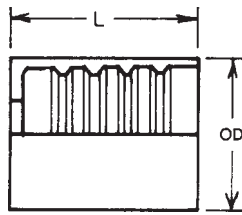

for SAE 100R1, 100R2, 100R3, Hydra-Lite I & II

Part Number	Hose I.D.	-L-	-O.D.-	-I.D.-
203-200	3/16	1.000	.687	.487
204-200	1/4	1.000	.814	.628
205-200	5/16	1.000	.814	.674
206-200	3/8	1.000	.937	.755
208-200	1/2	1.250	1.125	.880
210-200	5/8	1.250	1.225	.962
212-200	3/4	1.486	1.437	1.220
216-200	1	1.486	1.750	1.460
220-200	1-1/4	2.210	2.185	1.847
424-400	1-1/2	2.580	2.562	2.200
432-400	2	3.070	3.125	2.690

1 WIRE ALUMINUM FERRULE-SKIVE REQUIRED

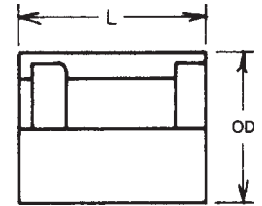

for SAE 100R1, and 1-Wire Grease Hose

Part Number	Hose I.D.	-L-	-O.D.-	-I.D.-
603-100	3/16	.750	.680	.488
608-100	1/2	1.125	1.000	.810
620-100	1-1/4	2.390	2.000	1.640

1 & 2 WIRE COMBINATION ALUMINUM FERRULE-SKIVE REQUIRED

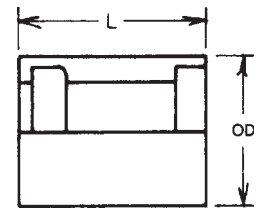

for SAE 100R1, 100R2, Hydra-Lite I & II

Part Number	Hose I.D.	-L-	-O.D.-	-I.D.-
603-200	3/16	1.000	.680	.488
604-200	1/4	1.031	.770	.580
605-200	5/16	1.031	.770	.580
606-200	3/8	1.031	.930	.720
608-200	1/2	1.250	1.125	.880
610-200	5/8	1.250	1.250	.987
612-200	3/4	1.406	1.437	1.173
616-200	1	1.486	1.750	1.430

1 & 2 WIRE COMBINATION NON-SKIVE STEEL FERRULE

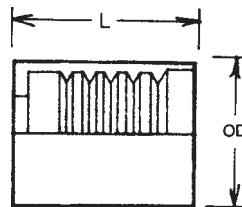

for SAE 100R1AT, 100R2AT, 100R5, Hydra-Lite I & II

Part Number	Hose I.D.	-L-	-O.D.-	-I.D.-
503-500	3/16	1.000	.825	.590
504-500	1/4	1.000	.873	.630
505-500	5/16	1.000	.965	.682
506-500	3/8	1.000	1.060	.793
508-500	1/2	1.230	1.153	.905
510-500	5/8	1.250	1.315	1.060
512-500	3/4	1.470	1.531	1.211
514-500	7/8	1.470	1.531	1.211
516-500	1	1.500	1.934	1.565
520-500	1-1/4	2.210	2.375	1.940
524-500	1-1/2	2.390	2.502	2.253
532-500	2	3.200	3.250	2.755

ALUMINUM FERRULE

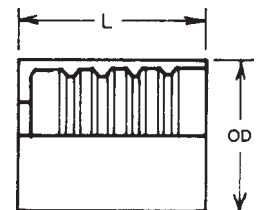

for SAE 100R3-100R4-100R6-GP

Part Number	Hose I.D.	-L-	-O.D.-	-I.D.-
603-300	3/16	1.000	.687	.487
604-300	1/4	1.000	.814	.628
606-300	3/8	1.000	.930	.785
608-300	1/2	1.250	1.125	.880
610-300	5/8	1.250	1.225	.962
612-300	3/4	1.125	1.562	1.290
616-300	1	1.375	1.740	1.547
620-300	1-1/4	2.210	2.185	1.847

SAE 100R3-100R4 STEEL FERRULE

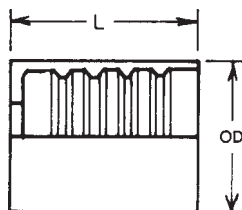

Part Number	Hose I.D.	-L-	-O.D.-	-I.D.-
312-300	3/4	1.470	1.500	1.330
316-300	1	1.470	1.750	1.540



Ferrules for SAE 100R1, 100R1AT, 100R2, 100R2AT, 100R3, 100R4, 100R5, Hydra-Lite I & II

1 & 2 WIRE COMBINATION NON-SKIVE ALUMINUM FERRULE

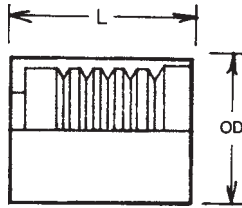

for SAE 100R1AT, 100R2AT, 100R5, Hydra-Lite I & II

Part Number	Hose I.D.	-L-	-O.D.-	-I.D.-
503-A-500	3/16	1.000	.817	.582
504-A-500	1/4	1.000	.875	.630
505-A-500	5/16	1.000	.965	.695
506-A-500	3/8	1.000	1.062	.783
508-A-500	1/2	1.230	1.187	.913
510-A-500	5/8	1.250	1.312	1.050
512-A-500	3/4	1.470	1.562	1.211
514-A-500	7/8	1.470	1.562	1.243
516-A-500	1	1.500	1.937	1.545
520-A-500	1-1/4	2.210	2.375	1.940

1 & 2 WIRE COMBINATION STAINLESS STEEL TYPE 316 FERRULE-SKIVE REQUIRED

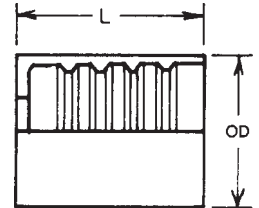

for SAE 100R1, 100R2, 100R3, Hydra-Lite I & II

Part Number	Hose I.D.	-L-	-O.D.-	-I.D.-
203-S16-200	3/16	1.000	.687	.487
204-S16-200	1/4	1.000	.814	.628
206-S16-200	3/8	1.000	.937	.755
208-S16-200	1/2	1.230	1.125	.880
210-S16-200	5/8	1.250	1.225	.962
212-S16-200	3/4	1.486	1.437	1.220
216-S16-200	1	1.486	1.750	1.460
420-S16-400	1-1/4	2.210	2.250	1.912
424-S16-400	1-1/2	2.580	2.562	2.200
432-S16-400	2	3.070	3.125	2.690

1 & 2 WIRE COMBINATION STAINLESS STEEL TYPE 303 FERRULE-SKIVE REQUIRED

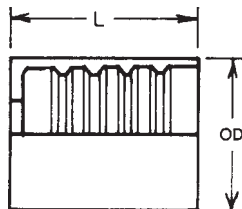

for SAE 100R1, 100R2, 100R3, Hydra-Lite I & II

Part Number	Hose I.D.	-L-	-O.D.-	-I.D.-
203-SS-200	3/16	1.000	.687	.487
204-SS-200	1/4	1.000	.814	.628
206-SS-200	3/8	1.000	.937	.755
208-SS-200	1/2	1.230	1.125	.880
210-SS-200	5/8	1.250	1.225	.962
212-SS-200	3/4	1.486	1.437	1.220
216-SS-200	1	1.486	1.750	1.460
420-SS-400	1-1/4	2.210	2.250	1.912
424-SS-400	1-1/2	2.580	2.562	2.200
432-SS-400	2	3.070	3.125	2.690

1 & 2 WIRE COMBINATION NON-SKIVE STAINLESS STEEL TYPE 303 FERRULE

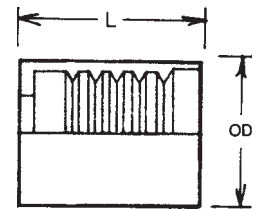

for SAE 100R1AT, 100R2AT, 100R5, Hydra-Lite I & II

Part Number	Hose I.D.	-L-	-O.D.-	-I.D.-
503-SS-500	3/16	1.000	.825	.590
504-SS-500	1/4	1.000	.873	.630
506-SS-500	3/8	1.000	1.060	.793
508-SS-500	1/2	1.230	1.153	.905
510-SS-500	5/8	1.250	1.315	1.060
512-SS-500	3/4	1.470	1.531	1.211
516-SS-500	1	1.500	1.934	1.565
520-SS-500	1-1/4	2.210	2.375	2.940
524-SS-500	1-1/2	2.390	2.502	2.253
532-SS-500	2	3.200	3.250	2.755

1 & 2 WIRE COMBINATION NON-SKIVE STAINLESS STEEL TYPE 316 FERRULE

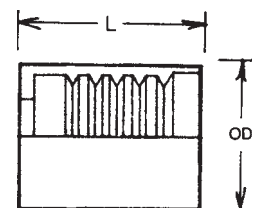

for SAE 100R1AT, 100R2AT, 100R5, Hydra-Lite I & II

Part Number	Hose I.D.	-L-	-O.D.-	-I.D.-
504-S16-500	1/4	1.000	.873	.630
506-S16-500	3/8	1.000	1.060	.793
508-S16-500	1/2	1.230	1.153	.905
512-S16-500	3/4	1.470	1.531	1.211
516-S16-500	1	1.500	1.934	1.565

Stems for SAE 100R1, 100R1AT, 100R2, 100R2AT, 100R3, 100R4, 100R5, Hydra-Lite I & II

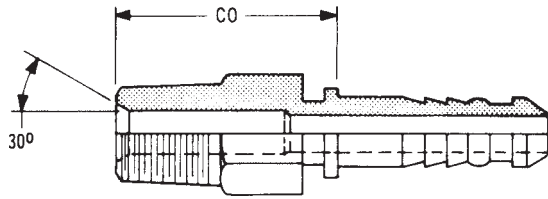

NPTF SOLID MALE STEM

Part Number	Hose I.D.	Thread	Hex	Stem I.D.	Fitting Length	-CO-Cutoff
203-102	3/16	1/8-27	1/2	.125	1.675	.765
203-104	3/16	1/4-18	9/16	.125	1.862	.952
204-102	1/4	1/8-27	5/8	.156	1.784	.874
204-104	1/4	1/4-18	5/8	.156	1.940	1.030
204-106	1/4	3/8-18	11/16	.156	1.940	1.030
204-LN-106	1/4	3/8-18	3/4	.156	2.315	1.405
204-108	1/4	1/2-14	7/8	.156	2.175	1.265
205-104	5/16	1/4-18	5/8	.234	1.940	1.030
205-106	5/16	3/8-18	11/16	.234	1.971	1.061
206-104	3/8	1/4-18	11/16	.296	1.971	1.061
206-106	3/8	3/8-18	11/16	.296	1.971	1.061
206-LN-106	3/8	3/8-18	11/16	.296	2.315	1.405
206-108	3/8	1/2-14	7/8	.296	2.222	1.312
208-106	1/2	3/8-18	3/4	.406	2.472	1.312
208-108	1/2	1/2-14	7/8	.406	2.472	1.312
208-112	1/2	3/4-14	1-1/16	.406	2.534	1.374
210-108	5/8	1/2-14	1-1/16	.500	2.534	1.374
210-112	5/8	3/4-14	1-1/8	.500	2.534	1.374
212-108	3/4	1/2-14	1-3/8	.562	2.614	1.364
212-112	3/4	3/4-14	1-1/16	.625	2.676	1.426
212-116	3/4	1 - 11-1/2	1-3/8	.625	2.926	1.676
214-112	7/8	3/4 - 14	1-1/4	.671	2.676	1.426
214-116	7/8	1 - 11-1/2	1-3/8	.671	2.926	1.676
216-112	1	3/4-14	1-3/8	.717	2.922	1.452
216-116	1	1 - 11-1/2	1-3/8	.843	3.172	1.702
220-120	1-1/4	1-1/4 - 11-1/2	1-3/4	1.062	3.943	2.020
220-SP-120	1-1/4	1-1/4 - 11-1/2	1-3/4	1.062	3.943	2.020
224-116	1-1/2	1 - 11-1/2	2	1.000	4.457	2.119
224-124	1-1/2	1-1/2 - 11-1/2	2	1.311	4.520	2.182
232-132	2	2 - 11-1/2	2-1/2	1.655	5.500	2.329

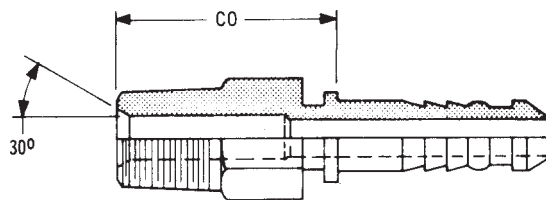

NPTF SOLID MALE STEM—STAINLESS STEEL TYPE 303

Part Number	Hose I.D.	Thread	Hex	Stem I.D.	Fitting Length	-CO-Cutoff
704-SS-104	1/4	1/4-18	11/16	.156	1.905	1.030
706-SS-104	3/8	1/4-18	11/16	.281	1.936	1.061
206-SS-104	3/8	1/4-18	11/16	.290	1.940	1.030
706-SS-106	3/8	3/8-18	11/16	.290	1.936	1.061
706-SS-108	3/8	1/2 - 14	7/8	.281	2.222	1.312
708-SS-106	1/2	3/8 - 18	3/4	.390	2.062	1.187
708-SS-108	1/2	1/2-14	7/8	.392	2.750	1.625
412-SS-112	3/4	3/4-14	1-1/16	.625	3.281	1.426
416-SS-116	1	1 - 11-1/2	1-3/8	.843	3.752	1.702
220-SS-120	1-1/4	1-1/4 - 11-1/2	1-3/4	1.062	3.943	2.020
224-SS-124	1-1/2	1-1/2 - 11-1/2	2	1.311	4.520	2.182
232-SS-132	2	2 - 11-1/2	2-1/2	1.544	5.550	2.329

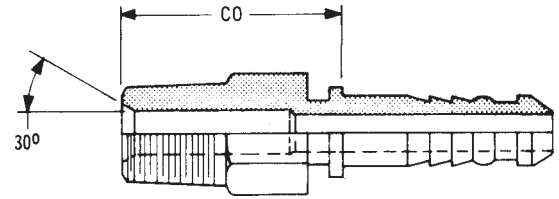

NPTF SOLID MALE STEM—STAINLESS STEEL TYPE 316

Part Number	Hose I.D.	Thread	Hex	Stem I.D.	Fitting Length	-CO-Cutoff
704-S16-104	1/4	1/4-18	11/16	.156	1.905	1.030
706-S16-104	3/8	1/4-18	11/16	.281	1.936	1.061
706-S16-106	3/8	3/8-18	11/16	.290	1.936	1.061
706-S16-108	3/8	1/2 - 14	7/8	.281	2.222	1.312
708-S16-106	1/2	3/8 - 18	3/4	.390	2.062	1.187
708-S16-108	1/2	1/2-14	7/8	.392	2.750	1.625
412-S16-112	3/4	3/4-14	1-1/16	.625	3.281	1.426
416-S16-116	1	1 - 11-1/2	1-3/8	.843	3.752	1.702
220-S16-120	1-1/4	1-1/4 - 11-1/2	1-3/4	1.062	3.943	2.020
224-S16-124	1-1/2	1-1/2 - 11-1/2	2	1.311	4.520	2.182
232-S16-132	2	2 - 11-1/2	2-1/2	1.544	5.550	2.329

NPTF SOLID MALE STEM FOR 1-WIRE GREASE HOSE

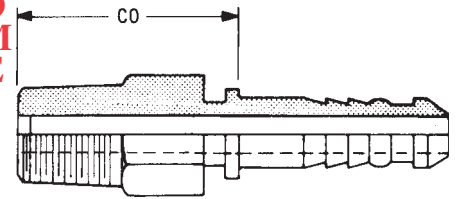

Part Number	Hose I.D.	Thread	Hex	Stem I.D.	Fitting Length	-CO-Cutoff
103-102	3/16	1/8-27	1/2	.125	1.327	.702

NPTF SWIVEL MALE STEM

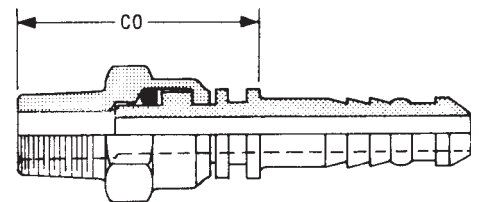

Leakage may occur at low pressure

Part Number	Hose I.D.	Thread	Nut Hex	Stem I.D.	Fitting Length	-CO-Cutoff
203-202	3/16	1/8-27	1/2	.125	1.955	1.050
203-204	3/16	1/4-18	11/16	.125	2.325	1.460
204-202	1/4	1/8-27	1/2	.156	2.002	1.092
204-204	1/4	1/4-18	11/16	.156	2.365	1.440
204-206	1/4	3/8-18	13/16	.156	2.515	1.625
204-208	1/4	1/2-14	7/8	.156	2.705	1.795
205-204	5/16	1/4-18	11/16	.234	2.373	1.463
205-206	5/16	3/8-18	13/16	.234	2.530	1.625
206-204	3/8	1/4-18	11/16	.218	2.510	1.605
206-206	3/8	3/8-18	13/16	.296	2.510	1.625
206-208	3/8	1/2-14	7/8	.296	2.700	1.810
208-206	1/2	3/8-18	1	.406	2.755	1.605
208-208	1/2	1/2-14	1	.406	2.955	1.800
210-212	5/8	3/4-14	1-5/16	.500	3.000	1.855
212-208	3/4	1/2-14	1-5/16	.625	3.125	1.890
212-212	3/4	3/4-14	1-5/16	.625	3.135	1.885
216-216	1	1 - 11-1/2	1-5/8	.844	3.760	2.300
220-220	1-1/4	1-1/4 - 11-1/2	1-3/4	.937	4.395	2.480



Stems for SAE 100R1, 100R1AT, 100R2, 100R2AT, 100R3, 100R4, 100R5, Hydra-Lite I & II

NPTF SWIVEL MALE STEM—STAINLESS

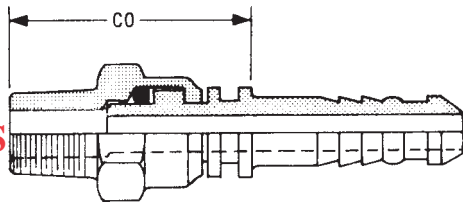

Part Number	Hose I.D.	Thread	Nut Hex	Stem I.D.	Fitting Length	-CO-Cutoff
206-SS-206	3/8	3/8 - 18	13/16	.296	2.510	1.625
208-SS-208	1/2	1/2 - 14	1	.406	2.955	1.800

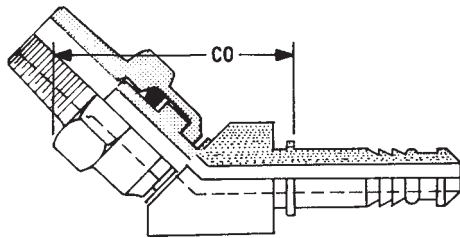

NPTF SWIVEL MALE—45° STEM

Leakage may occur at low pressure

Part Number	Hose I.D.	Thread	Nut Hex	Stem I.D.	-D-Drop	Fitting Length	-CO-Cutoff
204-206 45	1/4	3/8-18	13/16	.156	1.137	2.700	1.790
206-206 45	3/8	3/8-18	13/16	.296	1.137	2.700	1.790
208-206 45	1/2	3/8-18	1	.406	1.187	3.160	2.000
208-208 45	1/2	1/2-14	1	.406	1.250	3.300	2.140

NPTF SWIVEL MALE—90° STEM

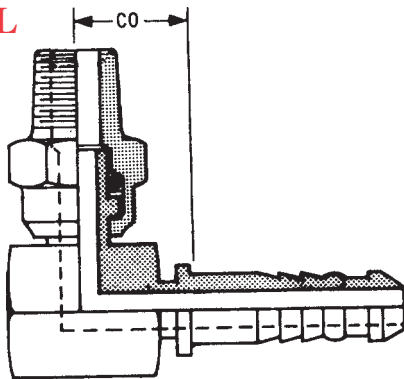

Leakage may occur at low pressure

Part Number	Hose I.D.	Thread	Nut Hex	Stem I.D.	-D-Drop	Fitting Length	-CO-Cutoff
203-202 90	3/16	1/8-27	1/2	.125	1.100	1.394	.484
204-204 90	1/4	1/4-18	11/16	.156	1.536	1.596	.686
204-206 90	1/4	3/8-18	13/16	.156	1.700	1.620	.710
206-204 90	3/8	1/4-18	11/16	.296	1.530	1.650	.710
206-206 90	3/8	3/8-18	13/16	.296	1.645	1.650	.710
206-208 90	3/8	1/2-14	7/8	.296	1.798	1.650	.710
208-206 90	1/2	3/8-18	13/16	.406	1.895	2.000	.840
208-208 90	1/2	1/2-14	1	.406	1.900	2.000	.840
208-212 90	1/2	3/4-14	1-5/16	.406	2.300	2.150	1.240
212-212 90	3/4	3/4-14	1-5/16	.625	2.300	2.350	1.100

SAE 45° SOLID MALE STEM

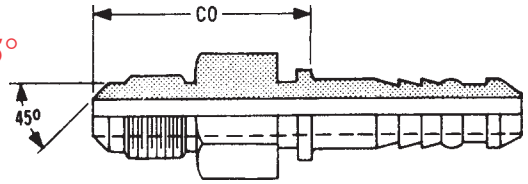

Part Number	Hose I.D.	Thread	Hex	Stem I.D.	Fitting Length	-CO-Cutoff
203-304	3/16	7/16-20	1/2	.125	1.846	.936
204-303	1/4	3/8-24	5/8	.156	2.815	.905
204-304	1/4	7/16-20	5/8	.156	1.878	.968
204-305	1/4	1/2-20	5/8	.156	1.939	1.029
206-306	3/8	5/8-18	11/16	.296	2.002	1.092
206-308	3/8	3/4-16	11/16	.296	2.159	1.249
208-308	1/2	3/4-16	13/16	.406	2.472	1.312
208-310	1/2	7/8-14	7/8	.406	2.602	1.442
210-310	5/8	7/8-14	1	.468	2.602	1.442
212-312	3/4	1-1/16 - 14	1-1/8	.625	2.926	1.676

GREASE FITTING STEM—SPECIAL

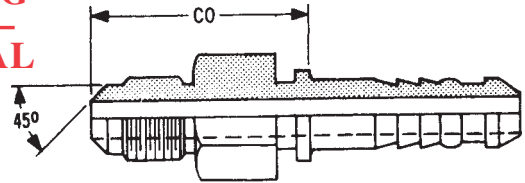

Part Number	Hose I.D.	Thread	Hex	Stem I.D.	Fitting Length	-CO-Cutoff
203-SP-304	3/16	7/16-20	5/8	.125	1.846	.936
203-SP-305	3/16	1/2-20	5/8	.125	2.375	1.465

SAE 45° SWIVEL FEMALE STEM

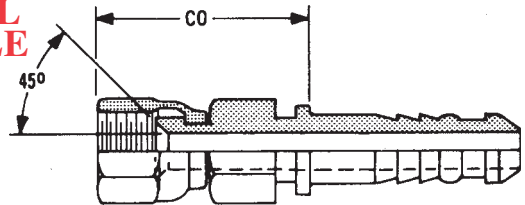

Part Number	Hose I.D.	Thread	Stem Hex	Nut Hex	Stem I.D.	Fitting Length	-CO-Cutoff
204-404	1/4	7/16-20	5/8	9/16	.156	1.995	1.075
204-405	1/4	1/2-20	5/8	11/16	.156	2.065	1.145
204-406	1/4	5/8-18	5/8	3/4	.156	2.130	1.215
205-405	5/16	1/2-20	5/8	11/16	.234	2.035	1.115
205-406	5/16	5/8-18	5/8	3/4	.234	2.115	1.205
206-404	3/8	7/16-20	11/16	9/16	.296	1.995	1.075
206-406	3/8	5/8-18	11/16	3/4	.296	2.115	1.195
206-408	3/8	3/4-16	11/16	7/8	.296	2.180	1.245
208-406	1/2	5/8-18	13/16	3/4	.296	2.413	1.253
208-408	1/2	3/4-16	13/16	7/8	.406	2.460	1.280
208-410	1/2	7/8-14	13/16	1-1/16	.406	2.545	1.395
210-410	5/8	7/8-14	1	1-1/16	.500	2.565	1.415
210-412	5/8	1-1/16 - 14	1	1-1/4	.500	2.690	1.510
212-410	3/4	7/8-14	1-1/16	1-1/16	.625	2.724	1.474
212-412	3/4	1-1/16 - 14	1-1/16	1-1/4	.625	2.805	1.555

Stems for SAE 100R1, 100R1AT, 100R2, 100R2AT, 100R3, 100R4, 100R5, Hydra-Lite I & II

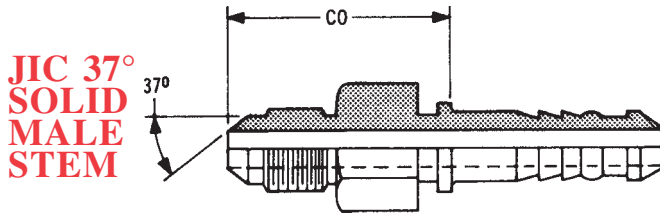

Part Number	Hose I.D.	Thread	Hex	Stem I.D.	Fitting Length	-CO-Cutoff
203-503	3/16	3/8-24	1/2	.125		
203-504	3/16	7/16-20	1/2	.125	1.846	.936
204-504	1/4	7/16-20	5/8	.156	1.923	1.013
204-505	1/4	1/2-20	5/8	.156	1.939	1.029
204-506	1/4	9/16-18	5/8	.156	1.933	1.023
204-507	1/4	5/8-18	5/8	.156	2.002	1.092
205-506	5/16	9/16-18	5/8	.234	1.933	1.023
206-506	3/8	9/16-18	11/16	.265	1.965	1.055
206-508	3/8	3/4-16	3/4	.296	2.065	1.155
206-510	3/8	7/8-14	7/8	.296	2.159	1.249
208-508	1/2	3/4-16	13/16	.390	2.378	1.218
208-510	1/2	7/8-14	7/8	.406	2.472	1.312
208-512	1/2	1-1/16 - 12	1-1/16	.406	2.589	1.429
210-508	5/8	3/4-16	1	.390	2.378	1.218
210-510	5/8	7/8-14	1	.468	2.472	1.312
210-512	5/8	1-1/16 - 12	1-1/16	.500	2.651	1.491
212-510	3/4	7/8-14	1-1/16	.468	2.676	1.426
212-512	3/4	1-1/16 - 12	1-1/8	.625	2.793	1.543
212-514	3/4	1-3/16 - 12	1-1/4	.625	2.793	1.543
212-516	3/4	1-5/16 - 12	1-3/8	.625	2.837	1.587
216-516	1	1-5/16 - 12	1-5/8	.844	3.146	1.676
216-520	1	1-5/8 - 12	1-5/8	.844	3.139	1.664
220-520	1-1/4	1-5/8 - 12	1-3/4	1.062	3.932	1.993
220-SP-520	1-1/4	1-5/8 - 12	1-3/4	1.062	3.932	1.993
220-524	1-1/4	1-7/8 - 12	2	1.062	4.067	2.118
224-524	1-1/2	1-7/8 - 12	2	1.312	4.598	2.260
232-532	2	2-1/2 - 12	2-5/8	1.655	5.802	2.635

JIC 37° RIGID SWIVEL FEMALE—W/INTERNAL “O” RING

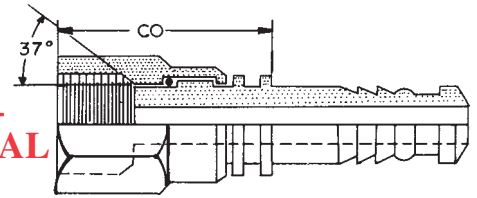

Leakage may occur at low pressure

Part Number	Hose I.D.	Thread	Nut Hex	Stem I.D.	Fitting Length	-CO-Cutoff
204-OR-606	1/4	9/16-18	3/4	.156	2.525	1.605
206-OR-608	3/8	3/4-16	7/8	.296	2.605	1.685
208-OR-610	1/2	7/8-14	1	.406	2.845	1.695

JIC 37° SWIVEL FEMALE STEM

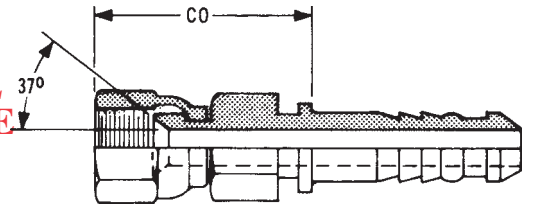

Part Number	Hose I.D.	Thread	Stem Hex	Nut Hex	Stem I.D.	Fitting Length	-CO-Cutoff
203-603	3/16	3/8-24	1/2	1/2	.125	1.885	.965
203-604	3/16	7/16-20	1/2	9/16	.125	1.885	.965
203-605	3/16	1/2-20	1/2	11/16	.125	1.985	1.050
204-604	1/4	7/16-20	5/8	9/16	.156	1.995	1.070
204-605	1/4	1/2-20	5/8	11/16	.156	2.050	1.125
204-606	1/4	9/16-18	5/8	3/4	.156	2.035	1.120
205-605	5/16	1/2-20	5/8	11/16	.203	2.040	1.120
205-606	5/16	9/16-18	5/8	3/4	.234	2.025	1.105
206-604	3/8	7/16-20	11/16	9/16	.171	1.984	1.074
206-606	3/8	9/16-18	11/16	3/4	.296	2.030	1.105
206-608	3/8	3/4-16	11/16	7/8	.296	2.165	1.245
206-610	3/8	7/8-14	13/16	1-1/16	.296	2.245	1.345
208-606	1/2	9/16-18	13/16	3/4	.296	2.340	1.165
208-608	1/2	3/4-16	13/16	7/8	.406	2.470	1.310
208-610	1/2	7/8-14	13/16	1-1/16	.406	2.530	1.370
208-612	1/2	1-1/16 - 12	1	1-1/4	.406	2.655	1.505
210-608	5/8	3/4-16	1	7/8	.406	2.455	1.295
210-610	5/8	7/8-14	1	1-1/16	.500	2.565	1.405
210-612	5/8	1-1/16 - 12	1	1-1/4	.500	2.655	1.485
210-614	5/8	1-3/16 - 12	1-1/8	1-3/8	.500	2.685	1.520
212-610	3/4	7/8-14	1-1/16	1-1/16	.500	2.745	1.490
212-612	3/4	1-1/16 - 12	1-1/16	1-1/4	.625	2.810	1.570
212-614	3/4	1-3/16 - 12	1-1/8	1-3/8	.625	2.830	1.585
212-616	3/4	1-5/16 - 12	1-1/4	1-1/2	.625	2.920	1.700
214-616	7/8	1-5/16 - 12	1-1/4	1-1/2	.671	2.910	1.665
216-612	1	1-1/16 - 12	1-3/8	1-1/4	.718	3.040	1.580
216-614	1	1-3/16 - 12	1-3/8	1-3/8	.844	3.055	1.600
216-616	1	1-5/16 - 12	1-3/8	1-1/2	.844	3.175	1.720
216-620	1	1-5/8 - 12	1-1/2	2	.844	3.175	1.825
220-620	1-1/4	1-5/8 - 12	1-3/4	2	1.062	4.155	2.195
220-SP-620	1-1/4	1-5/8 - 12	1-3/4	2	1.062	4.155	2.195
224-620	1-1/2	1-5/8 - 12	2	2	1.062	4.750	2.410
224-624	1-1/2	1-7/8 - 12	2	2-1/4	1.312	4.800	2.415
232-632	2	2-1/2 - 12	2-1/2	2-7/8	1.655	6.075	2.930

JIC 37° SOLID MALE LONG NOSE

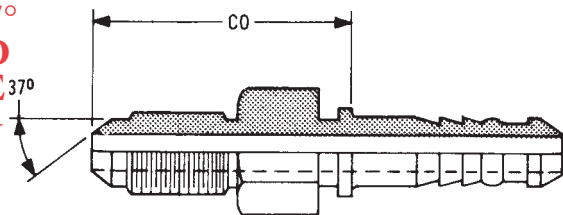

Part Number	Hose I.D.	Thread	Hex	Stem I.D.	Fitting Length	-CO-Cutoff
208-LN-510	1/2	7/8-14	7/8	.406	3.377	2.217
208-LN-512	1/2	1-1/16 - 12	1-1/16	.406	3.409	2.249
210-LN-512	5/8	1-1/16 - 12	1-1/16	.500	3.284	2.124
212-LN-512	3/4	1-1/16 - 12	1-1/8	.625	3.426	2.176



Stems for SAE 100R1, 100R1AT, 100R2, 100R2AT, 100R3, 100R4, 100R5, Hydra-Lite I & II

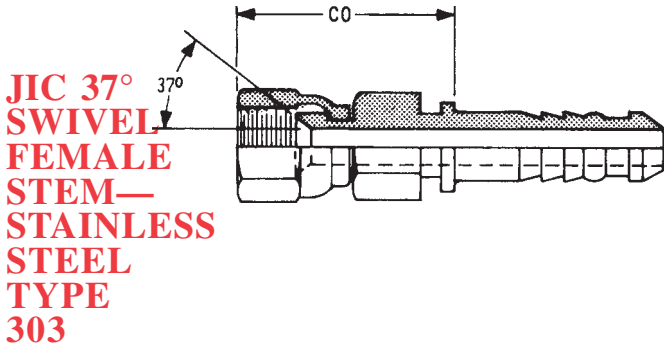

Part Number	Hose I.D.	Thread	Stem Hex	Nut Hex	Stem I.D.	Fitting Length	-CO-Cutoff
704-SS-604	1/4	7/16-20	5/8	9/16	.156	1.950	1.085
704-SS-606	1/4	9/16-18	5/8	3/4	.156	2.010	1.140
706-SS-606	3/8	9/16-18	11/16	3/4	.281	2.200	1.150
706-SS-608	3/8	3/4-16	11/16	7/8	.281	2.120	1.260
708-SS-608	1/2	3/4-16	13/16	7/8	.390	2.230	1.300
708-SS-610	1/2	7/8-14	13/16	1-1/16	.390	2.320	1.390
412-SS-612	3/4	1-1/16 - 12	1-1/16	1-1/4	.625	3.400	1.555
416-SS-616	1	1-5/16 - 12	1-3/8	1-1/2	.844	3.746	1.700
220-SS-620	1-1/4	1-5/8 - 12	1-3/4	2	1.062	4.155	2.235
224-SS-624	1-1/2	1-7/8 - 12	2	2-1/4	1.312	4.800	2.415
232-SS-632	2	2-1/2 - 12	2-5/8	2-7/8	1.655	6.075	2.930

ORB SOLID MALE STEM

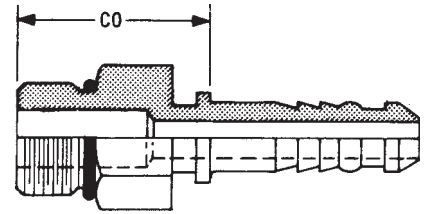

Part Number	Hose I.D.	Thread	Hex	Stem I.D.	Fitting Length	-CO-Cutoff
203-704	3/16	7/16-20	9/16	.125	1.690	.780
204-704	1/4	7/16-20	5/8	.156	1.737	.827
204-705	1/4	1/2-20	5/8	.156	1.737	.827
204-706	1/4	9/16-18	11/16	.156	1.769	.859
204-708	1/4	3/4 - 16	13/16	.154	1.937	1.027
205-705	5/16	1/2-20	11/16	.234	1.769	.859
205-706	5/16	9/16-18	11/16	.234	1.800	.890
206-704	3/8	7/16-20	11/16	.250	1.769	.859
206-705	3/8	1/2-20	11/16	.296	1.769	.859
206-706	3/8	9/16-18	3/4	.296	1.862	.952
206-708	3/8	3/4-16	7/8	.296	1.937	1.027
206-710	3/8	7/8-14	1	.296	1.972	1.062
206-712	3/8	1-1/16-12	1-1/4	.296	2.128	1.218
208-708	1/2	3/4-16	7/8	.406	2.160	1.000
208-710	1/2	7/8-14	1	.406	2.222	1.062
208-712	1/2	1-1/16 - 12	1-1/4	.406	2.348	1.188
210-708	5/8	3/4-16	1-1/8	.500	2.191	1.031
210-710	5/8	7/8-14	1	.500	2.438	1.278
210-712	5/8	1-1/16 - 12	1-1/4	.500	2.318	1.218
212-710	3/4	7/8-14	1-1/16	.625	2.333	1.083
212-712	3/4	1-1/16 - 12	1-1/4	.625	2.520	1.270
212-714	3/4	1-3/16 - 12	1-3/8	.625	2.520	1.270
212-716	3/4	1-5/16 - 12	1-1/2	.625	2.520	1.270
216-712	1	1-1/16 - 12	1-3/8	.844	2.829	1.359
216-714	1	1-3/16 - 12	1-3/8	.844	2.829	1.359
216-716	1	1-5/16 - 12	1-1/2	.844	2.829	1.359
220-720	1-1/4	1-5/8 - 12	1-3/4	1.062	3.568	1.646

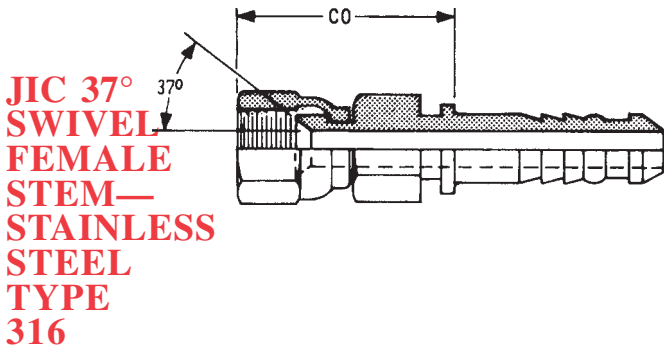

Part Number	Hose I.D.	Thread	Stem Hex	Nut Hex	Stem I.D.	Fitting Length	-CO-Cutoff
704-S16-604	1/4	7/16-20	5/8	9/16	.156	1.950	1.085
704-S16-606	1/4	9/16-18	5/8	3/4	.156	2.010	1.140
706-S16-606	3/8	9/16-18	11/16	3/4	.281	2.200	1.150
706-S16-608	3/8	3/4-16	11/16	7/8	.281	2.120	1.260
708-S16-608	1/2	3/4-16	13/16	7/8	.390	2.230	1.300
708-S16-610	1/2	7/8-14	13/16	1-1/16	.390	2.320	1.390
412-S16-612	3/4	1-1/16 - 12	1-1/16	1-1/4	.625	3.400	1.555
416-S16-616	1	1-5/16 - 12	1-3/8	1-1/2	.844	3.746	1.700
220-S16-620	1-1/4	1-5/8 - 12	1-3/4	2	1.062	4.155	2.235
224-S16-624	1-1/2	1-7/8 - 12	2	2-1/4	1.312	4.800	2.415
232-S16-632	2	2-1/2 - 12	2-5/8	2-7/8	1.655	6.075	2.930

ORB SWIVEL MALE STEM

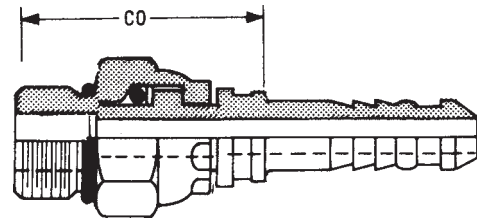

Leakage may occur at low pressure

Part Number	Hose I.D.	Thread	Nut Hex	Stem I.D.	Fitting Length	-CO-Cutoff
204-804	1/4	7/16-20	11/16	.156	2.260	1.340
204-805	1/4	1/2-20	11/16	.156	2.260	1.340
204-806	1/4	9/16-18	11/16	.156	2.270	1.365
204-808	1/4	3/4-16	7/8	.156	2.298	1.393
206-806	3/8	9/16-18	11/16	.218	2.320	1.405
206-808	3/8	3/4-16	7/8	.296	2.275	1.365
206-810	3/8	7/8-14	1	.296	2.485	1.570
208-808	1/2	3/4-16	1	.406	2.650	1.500
208-810	1/2	7/8-14	1	.406	2.695	1.535
210-810	5/8	7/8-14	1	.500	2.695	1.535
212-812	3/4	1-1/16 - 12	1-5/16	.625	3.125	1.890
212-814	3/4	1-3/16 - 12	1-5/16	.625	2.960	1.720

Stems for SAE 100R1, 100R1AT, 100R2, 100R2AT, 100R3, 100R4, 100R5, Hydra-Lite I & II



ORB SWIVEL MALE—45° STEM

Leakage may occur at low pressure

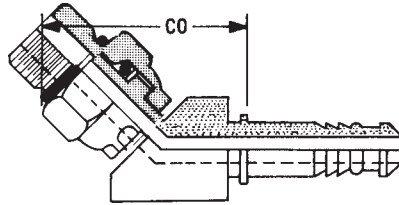

Part Number	Hose I.D.	Thread	Nut Hex	Stem I.D.	-D-Drop	Fitting Length	-CO-Cutoff
204-805 45	1/4	1/2-20	11/16	.156	.950	2.450	1.540
204-806 45	1/4	9/16-18	11/16	.156	.950	2.450	1.540

ORB SWIVEL MALE—90° STEM

Leakage may occur at low pressure

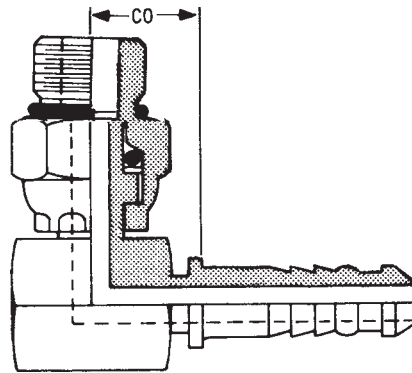

Part Number	Hose I.D.	Thread	Nut Hex	Stem I.D.	-D-Drop	Fitting Length	-CO-Cutoff
204-804 90	1/4	7/16-20	11/16	.156	1.416	1.600	.690
204-805 90	1/4	1/2-20	11/16	.156	1.426	1.600	.690
204-806 90	1/4	9/16-18	11/16	.156	1.426	1.600	.690
204-808 90	1/4	3/4-16	7/8	.156	1.470	1.620	.710
206-806 90	3/8	9/16-18	11/16	.218	1.426	1.600	.690
206-808 90	3/8	3/4-16	7/8	.296	1.470	1.620	.710
206-810 90	3/8	7/8-14	1	.296	1.780	1.600	.690
208-808 90	1/2	3/4-16	1	.406	1.660	2.000	.840
208-810 90	1/2	7/8-14	1	.406	1.725	1.970	.810
208-812 90	1/2	1-1/16 - 12	1-5/16	.406	2.144	2.150	.990
210-812-90	5/8	1-1/16 - 12	1-5/16	.500	2.144	2.181	1.062
212-812 90	3/4	1-1/16 - 12	1-5/16	.625	2.125	2.285	.990

NPTF SWIVEL FEMALE STEM W/"O" RING

Leakage may occur at low pressure

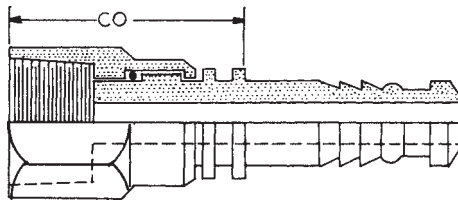

Part Number	Hose I.D.	Thread	Nut Hex	Stem I.D.	Fitting Length	-CO-Cutoff
204-004	1/4	1/4-18	11/16	.156	2.355	1.445
205-004	5/16	1/4-18	11/16	.234	2.355	1.445
206-006	3/8	3/8-18	7/8	.296	2.500	1.695
208-008	1/2	1/2-14	1	.406	3.010	1.850

NPTF SOLID FEMALE STEM

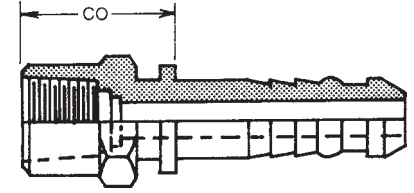

Part Number	Hose I.D.	Thread	Nut Hex	Stem I.D.	Fitting Length	-CO-Cutoff
203-902	3/16	1/8-27	9/16	.125	1.680	.765
204-902	1/4	1/8-27	5/8	.156	1.784	.874
204-904	1/4	1/4-18	11/16	.156	1.784	.874
204-906	1/4	3/8-18	13/16	.156	1.972	1.782
205-904	5/16	1/4-18	11/16	.234	1.784	.874
206-904	3/8	1/4-18	11/16	.296	1.784	.874
206-906	3/8	3/8-18	13/16	.296	1.847	.937
206-908	3/8	1/2-14	1	.296	2.050	1.140
208-906	1/2	3/8-18	13/16	.406	2.050	1.140
208-908	1/2	1/2-14	1	.406	2.300	1.140
212-912	3/4	3/4-14	1-1/4	.625	2.676	1.426
216-916	1	1 - 11-1/2	1-1/2	.844	3.031	1.561
220-920	1-1/4	1-1/4 - 11-1/2	1-7/8	1.062	3.756	1.834
224-924	1-1/2	1-1/2 - 11-1/2	2-1/4	1.311	4.175	1.837
232-932	2	2 - 11-1/2	2-5/8	1.655	5.024	2.069

SOLID FEMALE GREASE FITTING STEM

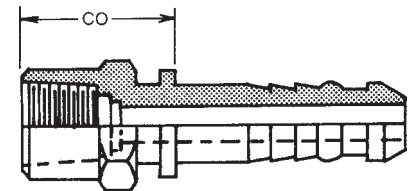

Part Number	Hose I.D.	Thread	Nut Hex	Stem I.D.	Fitting Length	-CO-Cutoff
204-SP-908	1/4	1/2-27	1-1/16	.156	1.784	.874
206-SP-908	3/8	1/2-27	1-1/16	.296	1.784	.874

45° SOLID FEMALE INVERTED FLARE STEM

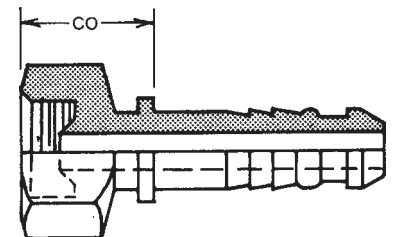

Part Number	Hose I.D.	Thread	Hex	Stem I.D.	Fitting Length	-CO-Cutoff
203-903 IF	3/16	3/8-24	1/2	.125	1.485	.575
204-904 IF	1/4	7/16-24	11/16	.156	1.597	.687
204-905 IF	1/4	1/2-20	11/16	.156	1.597	.687
204-906 IF	1/4	5/8-18	3/4	.156	1.597	.687
206-904 IF	3/8	7/16-24	3/4	.296	1.532	.622
206-905 IF	3/8	1/2-20	3/4	.296	1.532	.622
206-906 IF	3/8	5/8-18	3/4	.296	1.532	.622
206-908 IF	3/8	3/4-18	1	.296	1.532	.622
208-908 IF	1/2	3/4-18	1	.406	1.847	.687



Stems for SAE 100R1, 100R1AT, 100R2, 100R2AT, 100R3, 100R4, 100R5, Hydra-Lite I & II

MALE "O"-LOK STEM

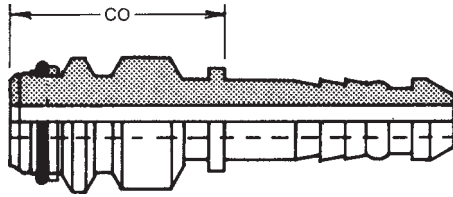

Part Number	Hose I.D.	Male Size	Stem I.D.	Fitting Length	-CO-Cutoff
204-S04	1/4	1/4	.156	2.227	1.317
206-S06	3/8	3/8	.296	2.227	1.317
208-S08	1/2	1/2	.406	2.477	1.317
412-S12	3/4	3/4	.625	2.619	1.369
416-S16	1	1	.843	3.370	1.600
220-S20	1-1/4	1-1/4	1.062	3.683	1.764
224-S24	1-1/2	1-1/2	1.250	4.320	1.555
232-S32	2	2	1.655	5.160	2.035

NPSM SWIVEL FEMALE STEM

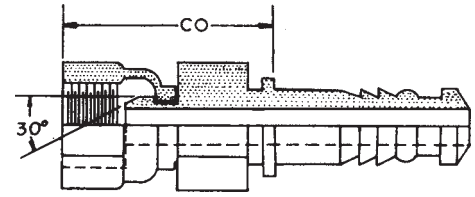

Part Number	Hose I.D.	Thread	Stem Hex	Nut Hex	Stem I.D.	Fitting Length	-CO-Cutoff
203-4 FPX	3/16	1/4-18	1/2	11/16	.125	1.829	.919
204-4 FPX	1/4	1/4-18	5/8	11/16	.156	1.937	1.027
204-6 FPX	1/4	3/8-18	5/8	7/8	.156	2.040	1.143
206-4 FPX	3/8	1/4-18	11/16	11/16	.250	1.960	1.079
206-6 FPX	3/8	3/8-18	11/16	7/8	.296	2.062	1.153
208-8 FPX	1/2	1/2-14	13/16	1	.406	2.390	1.230
210-12 FPX	5/8	3/4-14	1-1/8	1-1/4	.500	2.628	1.718
212-12 FPX	3/4	3/4-14	1-1/16	1-1/4	.625	2.769	1.519
216-16 FPX	1	1 - 11-1/2	1-3/8	1-1/2	.843	2.980	1.520
220-20 FPX	1-1/4	1-1/4 - 11-1/2	1-3/4	1-7/8	1.062	4.054	1.705

MALE "O"-LOK STEM—STAINLESS

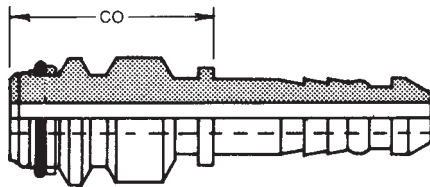

Part Number	Hose I.D.	Male Size	Stem I.D.	Fitting Length	-CO-Cutoff
206-SS-S06	3/8	3/8	.296	2.227	1.317
208-SS-S08	1/2	1/2	.406	2.477	1.317

NPSM SWIVEL FEMALE STEM—STAINLESS

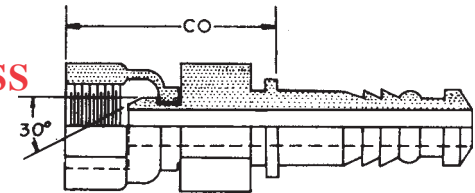

Part Number	Hose I.D.	Thread	Stem Hex	Nut Hex	Stem I.D.	Fitting Length	-CO-Cutoff
208-SS-8 FPX	1/2	1/2 - 14	13/16	1	.406	2.390	1.230

FEMALE "O"-LOK STEM

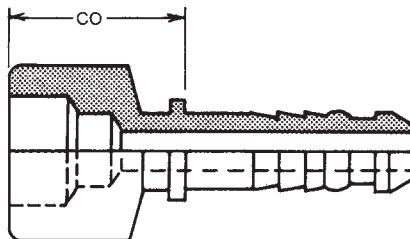

Part Number	Hose I.D.	Female Size	Stem I.D.	Fitting Length	-CO-Cutoff
232-F-S32	2	2	1.655	5.344	3.167

MALE FLARELESS STEM

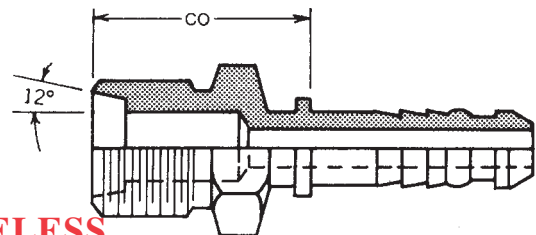

For Flareless Sleeve and Nut

Part Number	Hose I.D.	Thread	Hex	Stem I.D.	Fitting Length	-CO-Cutoff
204-E04	1/4	7/16-20	5/8	.156	1.831	.921
204-E05	1/4	1/2-20	5/8	.156	1.831	.921
204-E06	1/4	9/16-18	5/8	.156	1.847	.937
206-E04	3/8	7/16-20	11/16	.234	1.863	.953
206-E05	3/8	1/2-20	11/16	.234	1.863	.953
206-E06	3/8	9/16-18	11/16	.296	1.879	.969
206-E08	3/8	3/4-16	13/16	.296	1.971	1.061
208-E08	1/2	3/4-16	13/16	.406	2.285	1.125
208-E10	1/2	7/8-14	1	.406	2.348	1.188
208-E11	1/2	15/16-16	1	.406	2.347	1.187
212-E12	3/4	1-1/16 - 12	1-1/8	.625	2.614	1.364
216-E16	1	1-5/16 - 12	1-3/8	.844	2.923	1.453
216-SP-E16	1	1-5/16 - 16	1-5/8	.844	2.923	1.453
216-E20	1	1-5/8 - 12	1-3/4	.844	2.923	1.453
220-E20	1-1/4	1-5/8 - 12	1-3/4	1.062	3.662	1.738

Stems for SAE 100R1, 100R1AT, 100R2, 100R2AT, 100R3, 100R4, 100R5, Hydra-Lite I & II



NUT FOR MALE FLARELESS STEM

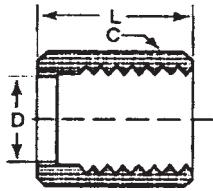

Part Number	Tube O.D.	Thread	Hex	Length
E04-N	1/4	7/16 - 20	9/16	.700
E05-N	5/16	1/2 - 20	5/8	.720
E06-N	3/8	9/16 - 18	11/16	.750
E08-N	1/2	3/4 - 16	7/8	.840
E10-N	5/8	7/8 - 14	1	.920
E12-N	3/4	1-1/16 - 12	1-1/4	.970
E16-N	1	1-5/16 - 12	1-3/8	1.050
E20-N	1-1/4	1-5/8 - 12	2	1.050

SLEEVE FOR MALE FLARELESS STEM

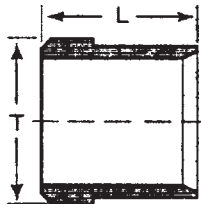

Part Number	Tube O.D.	Sleeve O.D.	Length
E04-S	1/4	.370	.360
E05-S	5/16	.420	.340
E06-S	3/8	.500	.390
E08-S	1/2	.660	.430
E10-S	5/8	.780	.440
E12-S	3/4	.930	.480
E16-S	1	1.190	.480
E20-S	1-1/4	1.450	.480

TUBE STEM

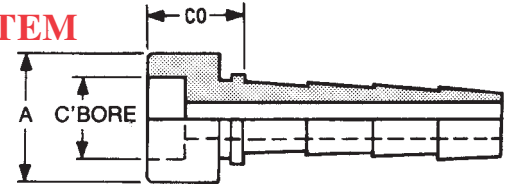

Part Number	Hose I.D.	C'Bore DIA	C'Bore Depth	-A-O.D.	Stem I.D.	Fitting Length	-CO-Cutoff
203-T03	3/16	3/16	.218	1/2	.125	1.390	.515
203-T04	3/16	1/4	.218	1/2	.125	1.390	.515
203-T05	3/16	5/16	.218	1/2	.125	1.390	.515
204-T03	1/4	3/16	.218	.604	.156	1.437	.562
204-T04	1/4	1/4	.218	.604	.156	1.437	.562
204-T05	1/4	5/16	.218	.604	.156	1.437	.562
204-T06	1/4	3/8	.218	.604	.156	1.437	.562
205-T04	5/16	1/4	.218	.604	.234	1.437	.562
205-T05	5/16	5/16	.218	.604	.234	1.437	.562
205-T06	5/16	3/8	.218	.604	.234	1.437	.562
206-T04	3/8	1/4	.218	3/4	.296	1.437	.562
206-T05	3/8	5/16	.218	3/4	.296	1.437	.562
206-T06	3/8	3/8	.218	3/4	.296	1.437	.562
206-T08	3/8	1/2	.218	3/4	.296	1.437	.562
206-T10	3/8	5/8	.218	1-3/16	.296	1.437	.562
208-T06	1/2	3/8	.218	7/8	.359	1.500	.562
208-T08	1/2	1/2	.218	7/8	.406	1.500	.562
208-T10	1/2	5/8	.218	1	.406	1.500	.562
208-T12	1/2	3/4	.218	1	.406	1.500	.562
210-T10	5/8	5/8	.312	1	.500	1.859	.734
210-T12	5/8	3/4	.312	1	.500	1.859	.734
212-T10	3/4	5/8	.375	1-3/16	.625	1.880	.755
212-T12	3/4	3/4	.375	1-3/16	.625	1.880	.755
212-T14	3/4	7/8	.375	1-3/16	.625	1.880	.755
212-T16	3/4	1	.375	1-3/16	.625	1.800	.755
216-T12	1	3/4	.375	1-1/2	.734	2.235	.765
216-T16	1	1	.375	1-1/2	.843	2.235	.765
420-T20	1-1/4	1-1/4	.375	1-7/16	1.062	2.840	1.920
420-T24	1-1/4	1-1/2	.375	1-3/4	1.062	2.840	1.920
424-T20	1-1/2	1-1/4	.375	1-13/16	1.234	3.562	2.659
424-T24	1-1/2	1-1/2	.375	1-13/16	1.250	3.258	2.338
424-T32	1-1/2	2	.375	2-1/4	1.250	3.258	2.338
432-T32	2	2	.375	2-1/4	1.655	4.086	3.167

SAE 45° SWIVEL FEMALE STEM 90° BENT TUBE SHORT DROP

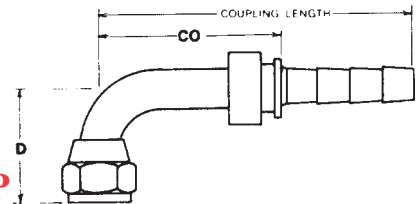

Part Number	Hose I.D.	Thread	Nut Hex	-D-Drop	Stem I.D.	Fitting Length	-CO-Cutoff
208-S-468	1/2	3/4-16	7/8	1.090	.406	2.557	1.620

SAE 45° SWIVEL FEMALE STEM 90° BENT TUBE MEDIUM DROP

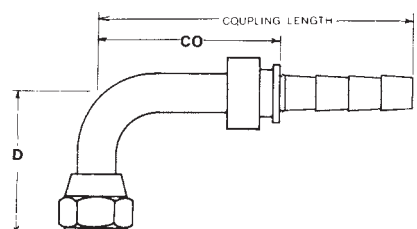

Part Number	Hose I.D.	Thread	Nut Hex	-D-Drop	Stem I.D.	Fitting Length	-CO-Cutoff
204-M-464	1/4	7/16-20	9/16	.880	.156	2.300	1.425
206-M-466	3/8	5/8-18	3/4	1.160	.296	2.640	1.765



Stems for SAE 100R1, 100R1AT, 100R2, 100R2AT, 100R3, 100R4, 100R5, Hydra-Lite I & II

JIC 37° SWIVEL FEMALE STEM 45° BENT TUBE SHORT DROP

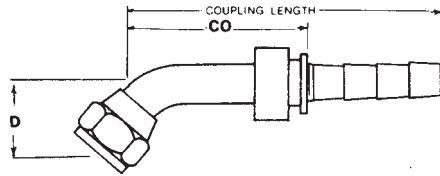

Part Number	Hose I.D.	Thread	Hex	-D-Drop	Fitting Length	-CO-Cutoff
203-S-684	3/16	7/16-20	9/16	.330	2.260	1.390
204-S-684	1/4	7/16-20	9/16	.330	2.570	1.695
204-S-685	1/4	1/2-20	5/8	.360	2.670	1.795
204-S-686	1/4	9/16-18	11/16	.410	2.890	2.010
205-S-685	5/16	1/2-20	5/8	.360	2.630	1.790
205-S-686	5/16	9/16-18	11/16	.410	2.890	2.015
206-S-686	3/8	9/16-18	11/16	.410	2.890	2.015
206-S-688	3/8	3/4-16	7/8	.550	3.240	2.240
208-S-688	1/2	3/4-16	7/8	.550	3.240	2.303
208-S-690	1/2	7/8-14	1	.650	3.540	2.603
210-S-690	5/8	7/8-14	1	.650	3.750	2.620
210-S-692	5/8	1-1/16 - 12	1-1/4	.780	4.010	2.885
212-S-692	3/4	1-1/16 - 12	1-1/4	.780	4.020	2.895
212-S-694	3/4	1-3/16 - 12	1-3/8	.860	4.280	3.150
212-S-696	3/4	1-5/16 - 12	1-1/2	.890	4.430	3.300
216-S-692	1	1-1/16 - 12	1-1/4	.780	4.430	2.960
216-S-696	1	1-5/16 - 12	1-1/2	.890	4.430	2.960

JIC 37° SWIVEL FEMALE STEM 45° BENT TUBE LONG DROP

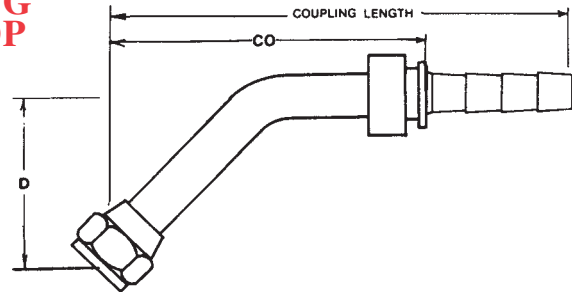

Part Number	Hose I.D.	Thread	Nut Hex	-D-Drop	Fitting Length	-CO-Cutoff
208-L-688	1/2	3/4-16	7/8	.700	3.400	2.500
208-L-690	1/2	7/8-14	1	.880	3.640	2.700
216-L-696	1	1-5/16 - 12	1-1/2	1.330	4.960	3.490

JIC 37° SWIVEL FEMALE STEM 45° BENT TUBE MEDIUM DROP

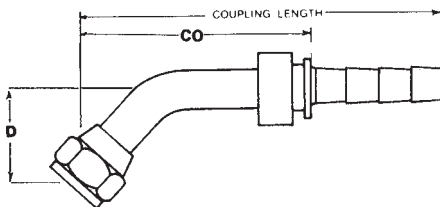

Part Number	Hose I.D.	Thread	Hex	-D-Drop	Fitting Length	-CO-Cutoff
204-M-684	1/4	7/16-20	9/16	.470	2.570	1.690
204-M-685	1/4	1/2-20	5/8	.590	2.670	1.790
204-M-686	1/4	9/16-18	11/16	.590	2.890	2.010
205-M-686	5/16	9/16-18	11/16	.590	2.890	2.010
206-M-686	3/8	9/16-18	11/16	.590	2.890	2.015
206-M-688	3/8	3/4-16	7/8	.690	3.240	2.200
208-M-688	1/2	3/4-16	7/8	.690	3.240	2.303
208-M-690	1/2	7/8-14	1	.780	3.540	2.600
210-M-690	5/8	7/8-14	1	.780	3.750	2.620
210-M-692	5/8	1-1/16 - 12	1-1/4	1.060	4.010	2.885
212-M-690	3/4	7/8-14	1	.780	3.770	2.640
212-M-692	3/4	1-1/16 - 12	1-1/4	1.060	4.020	2.895
212-M-696	3/4	1-5/16 - 12	1-1/2	1.160	4.440	3.310
216-M-696	1	1-5/16 - 12	1-1/2	1.160	4.780	3.315
420-M-698	1-1/4	1-5/8 - 12	2	1.300	6.840	4.920

JIC 37° SWIVEL FEMALE STEM 90° BENT TUBE SHORT DROP

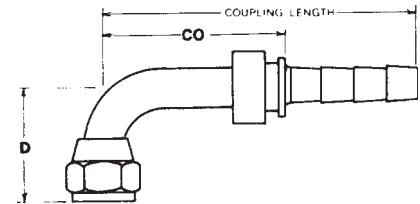

Part Number	Hose I.D.	Thread	Nut Hex	-D-Drop	Fitting Length	-CO-Cutoff
203-S-664	3/16	7/16-20	9/16	.780	2.260	1.390
204-S-664	1/4	7/16-20	9/16	.780	2.300	1.425
204-S-665	1/4	1/2-20	5/8	.900	2.390	1.510
204-S-666	1/4	9/16-18	11/16	.920	2.540	1.665
205-S-665	5/16	1/2-20	11/16	.920	2.210	1.350
205-S-666	5/16	9/16-18	11/16	.920	2.540	1.670
206-S-666	3/8	9/16-18	11/16	.920	2.540	1.670
206-S-668	3/8	3/4-16	7/8	1.170	2.635	1.755
208-S-668	1/2	3/4-16	7/8	1.170	2.697	1.760
208-S-670	1/2	7/8-14	1	1.320	3.060	2.123
210-S-670	5/8	7/8-14	1	1.320	3.260	2.135
210-S-672	5/8	1-1/16 - 12	1-1/4	1.870	3.860	2.730
212-S-670	3/4	7/8-14	1	1.320	3.290	2.160
212-S-672	3/4	1-1/16 - 12	1-1/4	1.870	3.880	2.755
212-S-674	3/4	1-3/16 - 12	1-3/8	2.000	4.250	3.120
212-S-676	3/4	1-5/16 - 12	1-1/2	2.240	4.375	3.250
216-S-676	1	1-5/16 - 12	1-1/2	2.240	4.720	3.250

Stems for SAE 100R1, 100R1AT, 100R2, 100R2AT, 100R3, 100R4, 100R5, Hydra-Lite I & II



JIC 37° SWIVEL FEMALE STEM 90° BENT TUBE MEDIUM DROP

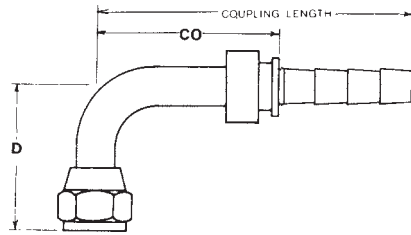

Part Number	Hose I.D.	Thread	Nut Hex	-D-Drop	Fitting Length	-CO-Cutoff
204-M-664	1/4	7/16-20	9/16	.880	2.300	1.425
204-M-665	1/4	1/2-20	5/8	1.130	2.390	1.515
204-M-666	1/4	9/16-18	11/16	1.130	2.540	1.670
205-M-666	5/16	9/16-18	11/16	1.130	2.540	1.670
206-M-666	3/8	9/16-18	11/16	1.130	2.540	1.670
206-M-668	3/8	3/4-16	7/8	1.380	2.760	1.885
208-M-668	1/2	3/4-16	7/8	1.380	2.760	1.823
208-M-670	1/2	7/8-14	1	1.750	3.060	2.123
210-M-670	5/8	7/8-14	1	1.750	3.260	2.135
210-M-672	5/8	1-1/16 - 12	1-1/4	2.060	3.860	2.730
212-M-670	3/4	7/8-14	1	1.750	3.290	2.160
212-M-672	3/4	1-1/16 - 12	1-1/4	2.060	3.880	2.755
212-M-676	3/4	1-5/16 - 12	1-3/8	2.620	4.370	3.240
216-M-676	1	1-5/16 - 12	1-3/8	2.620	4.720	3.250
216-M-678	1	1-5/8 - 12	1-1/2	3.400	5.850	4.400
420-M-678	1-1/4	1-5/8 - 12	1-1/2	3.500	6.840	4.920

JIC 37° SWIVEL FEMALE STEM 30° BENT TUBE SHORT DROP

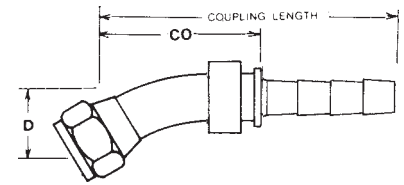

Part Number	Hose I.D.	Thread	Nut Hex	-D-Drop	Fitting Length	-CO-Cutoff
210-S-622	5/8	1-1/16 - 12	1-1/4	.480	3.620	2.49

SAE 45° MALE INVERTED SWIVEL STEM STRAIGHT TUBE

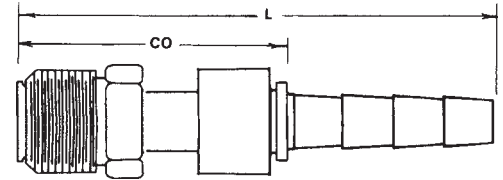

Part Number	Hose I.D.	Thread	Nut Hex	Fitting Length	-CO-Cutoff
203-B04	3/16	7/16-24	7/16	2.430	1.555
203-B05	3/16	1/2-20	1/2	2.560	1.685
204-B03	1/4	3/8-24	3/8	2.380	1.505
204-B04	1/4	7/16-24	7/16	2.440	1.565
204-B05	1/4	1/2-20	1/2	2.560	1.685
205-B05	5/16	1/2-20	1/2	2.560	1.685
205-B06	5/16	5/8-18	5/8	2.600	1.725
206-B04	3/8	7/16-24	7/16	2.440	1.565
206-B05	3/8	1/2-20	1/2	2.560	1.685
206-B06	3/8	5/8-18	5/8	2.600	1.725
206-B07	3/8	11/16-18	11/16	2.680	1.805
206-B08	3/8	3/4-18	3/4	2.800	1.925
208-B06	1/2	5/8-18	5/8	2.660	1.723
208-B08	1/2	3/4-18	3/4	2.860	1.923
208-B10	1/2	7/8-18	7/8	2.920	1.983

JIC 37° SWIVEL FEMALE STEM 90° BENT TUBE LONG DROP

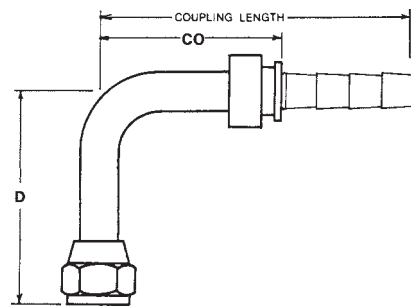

Part Number	Hose I.D.	Thread	Nut Hex	-D-Drop	Fitting Length	-CO-Cutoff
204-L-664	1/4	7/16-20	9/16	1.800	2.300	1.425
204-L-665	1/4	1/2-20	5/8	1.800	2.390	1.515
204-L-666	1/4	9/16-18	11/16	2.180	2.550	1.675
206-L-666	3/8	9/16-18	11/16	2.180	2.540	1.665
206-L-668	3/8	3/4-16	7/8	2.430	2.760	1.880
208-L-668	1/2	3/4-16	7/8	2.430	2.760	1.823
208-L-670	1/2	7/8-14	1	2.570	3.060	2.123
208-L-672	1/2	1-1/16-12	1-1/4	3.730	3.670	2.730
210-L-670	5/8	7/8-14	1	2.570	3.220	2.095
210-L-672	5/8	1-1/16 - 12	1-1/4	3.730	3.860	2.735
212-L-672	3/4	1-1/16 - 12	1-1/4	3.730	3.880	2.755
212-L-674	3/4	1-3/16 - 12	1-3/8	3.930	4.010	2.885
212-L-676	3/4	1-5/16 - 12	1-1/2	4.330	4.370	3.240
216-L-674	1	1-3/16 - 12	1-3/8	3.930	4.370	2.890
216-L-676	1	1-5/16 - 12	1-1/2	4.330	4.720	3.250



Stems for SAE 100R1, 100R1AT, 100R2, 100R2AT, 100R3, 100R4, 100R5, Hydra-Lite I & II

**SAE 45°
MALE
INVERTED
SWIVEL
STEM
45° BENT
TUBE**

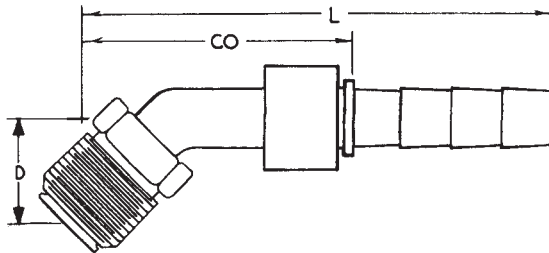

**SAE 45°
MALE
INVERTED
SWIVEL
STEM
90° BENT
TUBE**

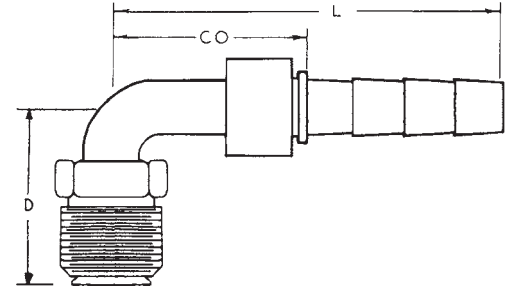

Part Number	Hose I.D.	Thread	Nut Hex	-D-Drop	Fitting Length	-CO-Cutoff
204-B43	1/4	3/8-24	3/8	.530	2.490	1.615
204-B44	1/4	7/16-24	7/16	.570	2.660	1.780
204-B45	1/4	1/2-20	1/2	.650	2.850	1.975
205-B46	5/16	5/8-18	5/8	.710	3.000	2.120
206-B44	3/8	7/16-24	7/16	.570	2.660	1.780
206-B45	3/8	1/2-20	1/2	.650	2.850	1.975
206-B46	3/8	5/8-18	5/8	.710	3.000	2.125
206-B47	3/8	11/16-18	11/16	.760	3.126	2.240
206-B48	3/8	3/4-18	3/4	.850	3.330	2.450
208-B48	1/2	3/4-18	3/4	.850	3.390	2.515
208-B50	1/2	7/8-18	7/8	.960	3.600	2.660

Part Number	Hose I.D.	Thread	Nut Hex	-D-Drop	Fitting Length	-CO-Cutoff
204-B63	1/4	3/8-24	3/8	.970	2.180	1.300
204-B64	1/4	7/16-24	7/16	1.100	2.380	1.505
204-B65	1/4	1/2-20	1/2	1.280	2.560	1.680
205-B65	5/16	1/2-20	1/2	1.280	2.560	1.680
205-B66	5/16	5/8-18	5/8	1.450	2.730	1.850
206-B64	3/8	7/16-24	7/16	1.100	2.380	1.500
206-B65	3/8	1/2-20	1/2	1.280	2.560	1.680
206-B66	3/8	5/8-18	5/8	1.450	2.730	1.855
206-B67	3/8	11/16-18	11/16	1.600	2.880	2.005
206-B68	3/8	3/4-18	3/4	1.780	3.060	2.180
208-B68	1/2	3/4-18	3/4	1.780	3.120	2.185
208-B70	1/2	7/8-18	7/8	2.090	3.370	2.430

**We have the capability
of producing a wide
range of metric and special
fittings made from steel, brass,
stainless and aluminum.**

Stems for SAE 100R1, 100R1AT, 100R2, 100R2AT, 100R3, 100R4, 100R5, 100R9, 100R12, Hydra-Lite I & II, Three Wire Braid & Spiral Hydraulic Hose



SOLID MALE FLAT FACE "O" RING SEAL STEM

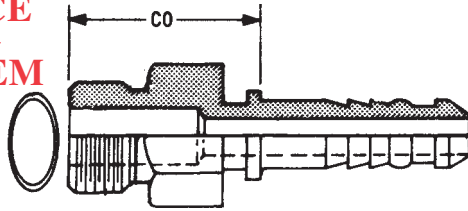

Part Number	Hose I.D.	Thread	Hex	Stem I.D.	Fitting Length	-CO- Cutoff	"O" Ring Part No.
204-FS-04	1/4	9/16-18	5/8	.156	1.764	.850	4 ORFS
204-FS-06	1/4	11/16-16	3/4	.156	1.850	.940	6 ORFS
206-FS-04	3/8	6/16-18	3/4	.265	1.858	.948	4 ORFS
206-FS-06	3/8	11/16-16	3/4	.265	1.850	.940	6 ORFS
206-FS-08	3/8	13/16-16	7/8	.265	1.976	1.066	8 ORFS
208-FS-06	1/2	11/16-16	7/8	.375	2.163	1.003	6 ORFS
208-FS-08	1/2	13/16-16	7/8	.375	2.226	1.065	8 ORFS
208-FS-10	1/2	1-14	1	.406	2.363	1.203	10 ORFS
210-FS-08	5/8	13/16-16	1-1/16	.482	2.257	1.097	8 ORFS
210-FS-10	5/8	1-14	1-1/16	.500	2.394	1.235	10 ORFS
210-FS-12	5/8	1-13/16-12	1-1/4	.482	2.485	1.325	12 ORFS
412-FS-10	3/4	1-14	1-1/4	.609	3.141	1.286	10 ORFS
412-FS-12	3/4	1-3/16-12	1-1/4	.609	3.201	1.345	12 ORFS
416-FS-16	1	1-7/16-12	1-1/2	.812	3.504	1.455	16 ORFS
220-FS-20	1-1/4	1-11/16-12	1-3/4	1.046	3.663	1.740	20 ORFS
224-FS-24	1-1/2	2-12	2-1/8	1.312	4.204	1.865	24 ORFS

SWIVEL FEMALE FLAT FACE "O" RING SEAL STEM 45°

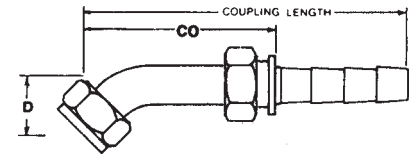

Part Number	Hose I.D.	Thread	Nut Hex	-D- Drop	Fitting Length	-CO- Cutoff
204-FSX-L64	1/4	9/16-18	11/16	.410	2.450	1.575
204-FSX-L66	1/4	11/16-16	13/16	.430	2.750	1.875
206-FSX-L66	3/8	11/16-16	13/16	.430	2.750	1.840
206-FSX-L68	3/8	13/16-16	15/16	.590	3.100	2.190
208-FSX-L68	1/2	13/16-16	15/16	.590	3.350	2.190
210-FSX-L70	5/8	1-14	1-1/8	.650	3.750	2.590
412-FSX-L72	3/4	1-3/16-12	1-3/8	.830	4.525	2.670
416-FSX-L76	1	1-7/16-12	1-5/8	.940	5.625	3.575
220-FSX-L80	1-1/4	1-11/16-12	1-7/8	1.000	5.930	4.007
224-FSX-L84	1-1/2	2-12	2-1/8	2.440	8.488	6.110

SWIVEL FEMALE FLAT FACE "O" RING SEAL STEM 90°—SHORT DROP

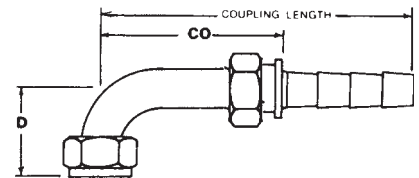

Part Number	Hose I.D.	Thread	Nut Hex	-D- Drop	Fitting Length	-CO- Cutoff
204-FSX-A24	1/4	9/16-18	11/16	.820	2.425	1.550
206-FSX-A26	3/8	11/16-16	13/16	.900	2.750	1.840
206-FSX-A28	3/8	13/16-16	15/16	1.150	3.170	2.230
208-FSX-A28	1/2	13/16-16	15/16	1.150	3.375	2.215
208-FSX-A30	1/2	1-14	1-1/8	1.490	3.010	1.850
208-FSX-A32	1/2	1-3/16-12	1-3/8	1.895	4.000	2.840
210-FSX-A30	5/8	1-14	1-1/8	1.490	3.400	2.250
210-FSX-A32	5/8	1-3/16-12	1-3/8	1.895	4.000	2.830
412-FSX-A32	3/4	1-3/16-12	1-3/8	1.880	4.705	2.850
416-FSX-A36	1	1-7/16-12	1-5/8	2.200	5.875	3.825
220-FSX-A40	1-1/4	1-11/16-12	1-7/8	2.500	5.825	3.902
224-FSX-A44	1-1/2	2-12	2-1/8	3.190	5.750	3.412

SWIVEL FEMALE FLAT FACE "O" RING SEAL STEM STRAIGHT

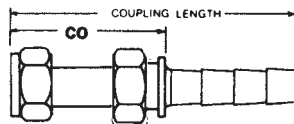

Part Number	Hose I.D.	Thread	Stem Hex	Nut Hex	Fitting Length	-CO- Cutoff
204-FSX-04	1/4	9/16-18	5/8	11/16	1.702	.792
204-FSX-06	1/4	11/16-16	5/8	13/16	1.727	.817
206-FSX-06	3/8	11/16-16	11/16	13/16	1.727	.817
206-FSX-08	3/8	13/16-16	3/4	15/16	1.764	.854
208-FSX-06	1/2	11/16-16	7/8	13/16	1.977	.817
208-FSX-08	1/2	13/16-16	13/16	15/16	2.062	.902
208-FSX-10	1/2	1-14	7/8	1-1/8	2.079	.919
208-FSX-12	1/2	1-3/16-12	1-1/8	1-3/8	2.092	.932
210-FSX-10	5/8	1-14	1	1-1/8	2.127	.967
210-FSX-12	5/8	1-3/16-12	1-1/8	1-3/8	2.140	.980
412-FSX-08	3/4	13/16-16	1-1/16	15/16	2.856	1.001
412-FSX-10	3/4	1-14	1-1/16	1-1/8	2.874	1.019
412-FSX-12	3/4	1-3/16-12	1-1/16	1-3/8	2.887	1.032
412-FSX-16	3/4	1-7/16-12	1-3/8	1-5/8	3.022	1.167
416-FSX-16	1	1-7/16-12	1-3/8	1-5/8	3.243	1.193
220-FSX-20	1-1/4	1-11/16-12	1-3/4	1-7/8	4.090	2.167
224-FSX-24	1-1/2	2-12	2	2-1/8	4.708	2.370

SWIVEL FEMALE FLAT FACE "O" RING SEAL STEM 90°—MEDIUM DROP

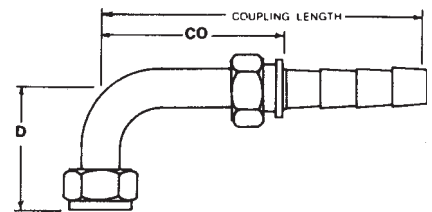

Part Number	Hose I.D.	Thread	Nut Hex	-D- Drop	Fitting Length	-CO- Cutoff
204-FSX-J34	1/4	9/16-18	11/16	1.260	2.450	1.550
204-FSX-J36	1/4	11/16-16	13/16	1.500	2.850	1.985
206-FSX-J36	3/8	11/16-16	13/16	1.500	2.850	1.940
208-FSX-J38	1/2	13/16-16	15/16	1.620	3.425	2.300
208-FSX-J40	1/2	1-14	1-1/8	1.850	3.240	2.319
210-FSX-J40	5/8	1-14	1-1/8	1.850	3.550	2.350
412-FSX-J42	3/4	1-3/16-12	1-3/8	2.280	4.575	2.720
416-FSX-J46	1	1-7/16-12	1-5/8	2.780	5.625	3.550
220-FSX-J50	1-1/4	1-11/16-12	1-7/8	3.090	5.925	4.025
224-FSX-J54	1-1/2	2-12	2-1/8	4.630	7.148	4.810



Stems for SAE 100R1, 100R1AT, 100R2, 100R2AT, 100R3, 100R4, 100R5, 100R9, 100R12, Hydra-Lite I & II, Three Wire Braid & Spiral Hydraulic Hose

SWIVEL FEMALE FLAT FACE "O" RING SEAL STEM 90°—LONG DROP

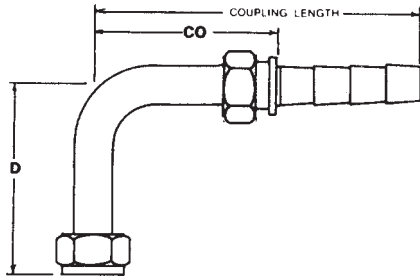

Part Number	Hose I.D.	Thread	Nut Hex	-D-Drop	Fitting Length	-CO-Cutoff
204-FSX-A64	1/4	9/16 - 18	11/16	1.800	2.450	1.575
206-FSX-A66	3/8	11/16 - 16	13/16	2.130	2.875	1.965
208-FSX-A68	1/2	13/16 - 16	15/16	2.500	3.450	2.300
208-FSX-A70	1/2	1 - 14	1-1/8	2.750	3.730	2.570
210-FSX-A70	5/8	1 - 14	1-1/8	2.750	3.730	2.600
412-FSX-A72	3/4	1-3/16 - 12	1-3/8	3.780	4.550	2.750
416-FSX-A76	1	1-7/16 - 12	1-5/8	4.500	5.590	3.540
220-FSX-A80	1-1/4	1-11/16 - 12	1-7/8	5.090	5.875	3.975

SHORT TAILPIECE SWIVEL FEMALE FLAT FACE "O" RING SEAL

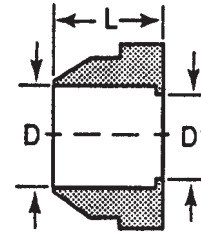

Part Number	Tube Size	D	D1	-L- Length
-4 TPS	1/4	.256	.173	.370
-6 TPS	3/8	.381	.264	.370
-8 TPS	1/2	.506	.382	.370
-10 TPS	5/8	.631	.484	.410
-12 TPS	3/4	.757	.610	.550
-16 TPS	1	1.007	.808	.610
-20 TPS	1-1/4	1.257	1.050	.610
-24 TPS	1-1/2	1.507	1.314	.610

TUBE STEM FLAT FACE "O" RING SEAL

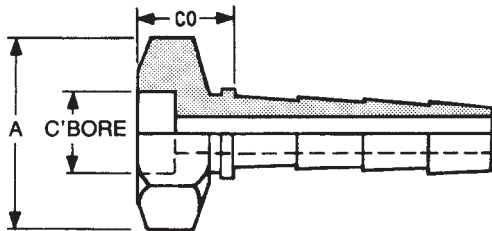

Part Number	Hose I.D.	C'Bore DIA	C'Bore Depth	Hex	Stem I.D.	Fitting Length	-CO-Cutoff
204-FS-T04	1/4	1/4	.218	5/8	.156	1.437	.562
204-FS-T06	1/4	3/8	.218	5/8	.156	1.437	.562
406-FS-T06	3/8	3/8	.375	11/16	.296	1.597	.687
406-FS-T08	3/8	1/2	.375	11/16	.296	1.597	.687
408-FS-T06	1/2	3/8	.375	7/8	.406	1.847	.687
408-FS-T08	1/2	1/2	.375	7/8	.406	1.847	.687
408-FS-T10	1/2	5/8	.375	7/8	.406	1.847	.687
408-FS-T12	1/2	3/4	.375	7/8	.406	1.847	.687
410-FS-T10	5/8	5/8	.375	1	.500	1.878	.718
410-FS-T12	5/8	3/4	.375	1	.500	1.878	.718
412-FS-T08	3/4	1/2	.375	1-1/16	.406	2.566	.711
412-FS-T10	3/4	5/8	.375	1-1/16	.406	2.566	.711
412-FS-T12	3/4	3/4	.375	1-1/16	.406	2.566	.711
416-FS-T16	1	1	.375	1-3/8	.843	2.800	.750
420-FS-T20	1-1/4	1-1/4	.375	1-3/4	1.062	2.840	.920
424-FS-T24	1-1/2	1-1/2	.375	2	1.250	3.258	.920

SWIVEL NUT SWIVEL FEMALE FLAT FACE "O" RING SEAL

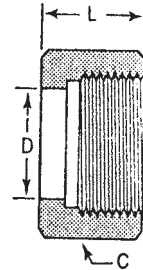

Part Number	Size	Thread Size	Hex	D	-L- Length
-4 FFORS	1/4	9/16 - 18	11/16	.530	.580
-6 FFORS	3/8	11/16 - 16	13/16	.610	.670
-8 FFORS	1/2	13/16 - 16	15/16	.700	.830
-10 FFORS	5/8	1 - 14	1-1/8	.720	.930
-12 FFORS	3/4	1-3/16 - 12	1-3/8	.750	1.020
-16 FFORS	1	1-7/16 - 12	1-5/8	.840	1.100
-20 FFORS	1-1/4	1-11/16 - 12	1-7/8	.920	1.100
-24 FFORS	1-1/2	2 - 12	2-1/4	.970	1.100

VICTAULIC GROOVE STEM

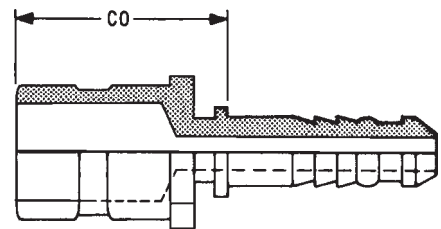

Part Number	Hose I.D.	Stem I.D.	Fitting Length	-CO-Cutoff
216-V16	1	.844	3.410	1.940
220-V20	1-1/4	1.062	4.024	2.000

British Standard and Metric Stems



BRITISH STANDARD PARALLEL PIPE—BSPB SOLID MALE STEM 30° SEAT

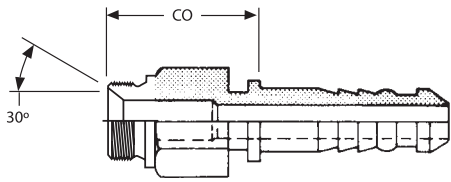

Part Number	Hose I.D.	Thread	Hex	Fitting Length	-CO-Cutoff
204-BP-104	1/4	1/4-19	3/4	1.891	.981
206-BP-106	3/8	3/8-19	7/8	1.981	1.071
208-BP-108	1/2	1/2-14	1-1/16	2.392	1.232
412-BP-112	3/4	3/4-14	1-1/4	3.281	1.426
416-BP-116	1	1-11	1-5/8	3.645	1.595

BSPB SWIVEL FEMALE STEM 30° CONE 45° BENT TUBE

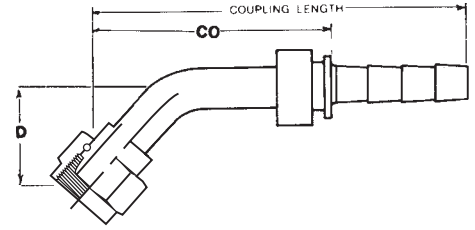

Part Number	Hose I.D.	Thread	Nut Hex	-D-Drop	Fitting Length	-CO-Cutoff
204-BPX-4 45	1/4	1/4-19	11/16	.500	2.565	1.690
204-BPX-6 45	1/4	3/8-19	7/8	.625	2.885	2.010
206-BPX-6 45	3/8	3/8-19	7/8	.625	2.885	2.010
208-BPX-8 45	1/2	1/2-14	1	.750	3.137	2.200
210-BPX-10 45	5/8	5/8-14	1-1/16	.875	3.745	2.620
210-BPX-12 45	5/8	3/4-14	1-1/4	1.125	3.875	2.750
412-BPX-12 45	3/4	3/4-14	1-1/4	1.125	4.755	2.900
416-BPX-16 45	1	1-11	1-1/2	1.250	5.360	3.310

JIS SWIVEL FEMALE STEM 30° SEAT

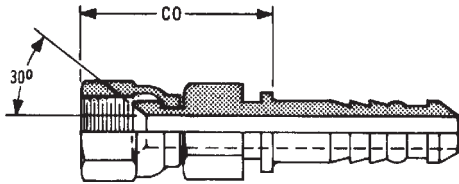

Part Number	Hose I.D.	Thread	Nut Hex	Stem Hex	Fitting Length	-CO-Cutoff
204-BP-604	1/4	1/4-19	11/16	5/8	1.937	1.027
206-BP-606	3/8	3/8-19	7/8	11/16	2.033	1.123
208-BP-608	1/2	1/2-14	1	13/16	2.378	1.218
412-BP-612	3/4	3/4-14	1-1/4	1-1/16	3.344	1.489
416-BP-616	1	1-11	1-1/2	1-3/8	3.565	1.515
220-BP-620	1-1/4	1-1/4-11	1-7/8	1-3/4	4.036	2.114

BSPB SWIVEL FEMALE STEM 30° CONE 90° BENT TUBE

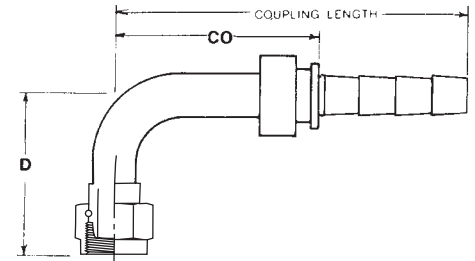

Part Number	Hose I.D.	Thread	Nut Hex	-D-Drop	Fitting Length	-CO-Cutoff
204-BPX-4 90	1/4	1/4-19	11/16	1.625	2.390	1.515
206-BPX-6 90	3/8	3/8-19	7/8	1.625	2.540	1.665
208-BPX-8 90	1/2	1/2-14	1	1.750	2.817	1.880
208-BPX-10 90	1/2	5/8-14	1-1/16	2.000	3.057	2.120
210-BPX-10 90	5/8	5/8-14	1-1/16	2.000	3.265	2.140
210-BPX-12 90	5/8	3/4-14	1-1/4	2.250	3.265	2.140
412-BPX-12 90	3/4	3/4-14	1-1/4	2.250	4.610	2.755
416-BPX-16 90	1	1-11	1-1/2	2.250	4.940	2.890
220-BPX-20 90	1-1/4	1-1/4-11	1-7/8	4.500	6.843	4.920

BRITISH STANDARD PARALLEL PIPE SWIVEL FEMALE STEM 30° CONE

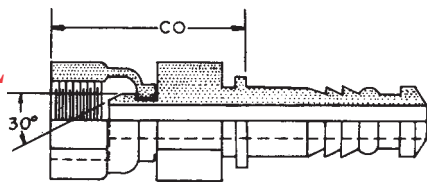

Part Number	Hose I.D.	Thread	Nut Hex	Stem Hex	Fitting Length	-CO-Cutoff
204-BPX-4	1/4	1/4-19	11/16	5/8	1.939	1.029
204-BPX-6	1/4	3/8-19	7/8	5/8	2.033	1.123
206-BPX-6	3/8	3/8-19	7/8	11/16	2.033	1.123
206-BPX-8	3/8	1/2-14	1	13/16	2.127	1.217
208-BPX-8	1/2	1/2-14	1	13/16	2.377	1.217
208-BPX-10	1/2	5/8-14	1-1/16	13/16	2.464	1.304
210-BPX-10	5/8	5/8-14	1-1/16	1	2.543	1.383
210-BPX-12	5/8	3/4-14	1-1/4	1	2.628	1.468
412-BPX-12	3/4	3/4-14	1-1/4	1-1/16	3.344	1.489
416-BPX-16	1	1-11	1-1/2	1-3/8	3.565	1.515
220-BPX-20	1-1/4	1-1/4-11	1-7/8	1-3/4	4.036	2.114

BRITISH STANDARD TAPERED PIPE BSPT SOLID MALE STEM 30° SEAT

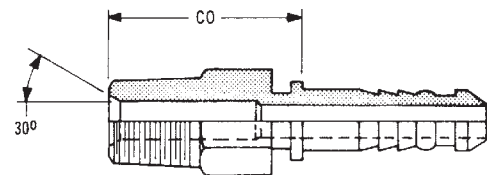

Part Number	Hose I.D.	Thread	Hex	Fitting Length	-CO-Cutoff
204-BT-104	1/4	1/4-19	5/8	1.875	.965
204-BT-106	1/4	3/8-19	11/16	1.875	.965
206-BT-106	3/8	3/8-19	11/16	1.906	.996
208-BT-108	1/2	1/2-14	7/8	2.316	1.156
412-BT-112	3/4	3/4-14	1-1/16	3.197	1.342
416-BT-116	1	1-11	1-3/8	3.603	1.553



British Standard and Metric Stems

KOMATSU SWIVEL FEMALE STEM 30° SEAT

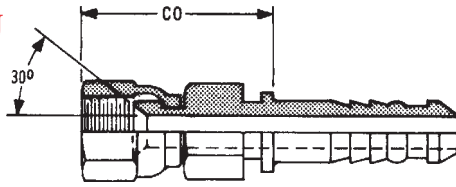

Part Number	Hose I.D.	Thread	Nut Hex	Stem Hex	Fitting Length	-CO-Cutoff
204-KU-614	1/4	14MM X 1.5	3/4	5/8	2.035	1.125
204-KU-618	1/4	18MM X 1.5	7/8	11/16	2.158	1.248
206-KU-618	3/8	18MM X 1.5	7/8	11/16	2.158	1.248
208-KU-622	1/2	22MM X 1.5	1-1/16	13/16	2.545	1.385
208-KU-624	1/2	24MM X 1.5	1-1/4	1	2.631	1.471
210-KU-624	5/8	24MM X 1.5	1-1/4	1	2.662	1.502
412-KU-630	3/4	30MM X 1.5	1-1/2	1-1/4	3.584	1.729
416-KU-633	1	33MM X 1.5	1-5/8	1-3/8	3.805	1.755
220-KU-636	1-1/4	36MM X 1.5	1-3/4	1-3/4	4.198	2.276
224-KU-642	1-1/2	42MM X 1.5	2-1/4	2	4.795	2.457

METRIC SWIVEL FEMALE STEM DIN 20078 LIGHT 45° BENT TUBE W/ O-RING

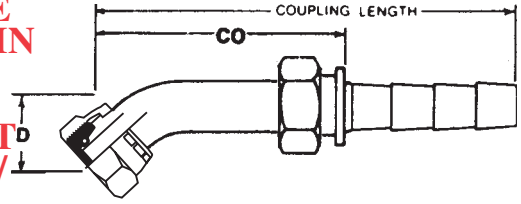

Part Number	Hose I.D.	Thread	DIN Tube O.D.(mm)	Nut Hex (mm)	-D-Drop	Fitting Length	-CO-Cutoff
206-DL-616 45	3/8	16MM X 1.5	10	19	.827	2.638	1.728
206-DL-618 45	3/8	18MM X 1.5	12	22	.846	2.677	1.767
208-DL-622 45	1/2	22MM X 1.5	15	27	.984	3.189	2.029

SOLID MALE STEM DIN 20078 LIGHT 12° SEAT

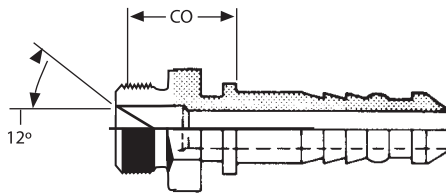

Part Number	Hose I.D.	Thread	Hex	Fitting Length	-CO-Cutoff
204-DL-112	1/4	12MM X 1.5	1/2	1.793	.883
204-DL-114	1/4	14MM X 1.5	5/8	1.793	.883
206-DL-116	3/8	16MM X 1.5	11/16	1.824	.914
206-DL-118	3/8	18MM X 1.5	3/4	1.824	.914
208-DL-122	1/2	22MM X 1.5	7/8	2.222	1.062
210-DL-126	5/8	26MM X 1.5	1-1/16	2.253	1.093
412-DL-126	3/4	26MM X 1.5	1-1/16	3.031	1.176
412-DL-130	3/4	30MM X 2	1-1/4	3.081	1.226

METRIC SWIVEL FEMALE STEM DIN 20078 LIGHT 90° BENT TUBE W/ O-RING

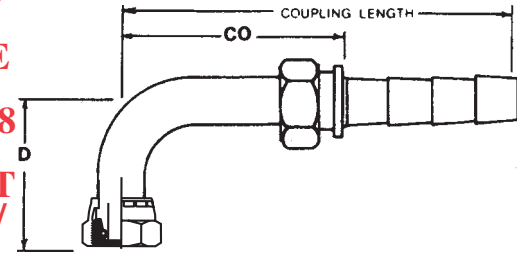

Part Number	Hose I.D.	Thread	DIN Tube O.D.(mm)	Nut Hex (mm)	-D-Drop	Fitting Length	-CO-Cutoff
204-DL-614 90	1/4	14MM X 1.5	8	17	1.378	1.929	1.019
206-DL-616 90	3/8	16MM X 1.5	10	19	1.575	2.244	1.334
206-DL-618 90	3/8	18MM X 1.5	12	22	1.614	2.244	1.334
208-DL-622 90	1/2	22MM X 1.5	15	27	1.890	2.717	1.557
210-DL-626 90	5/8	26MM X 1.5	18	32	2.185	3.071	1.911

METRIC SWIVEL FEMALE STEM DIN 20078 LIGHT STRAIGHT W/ O-RING

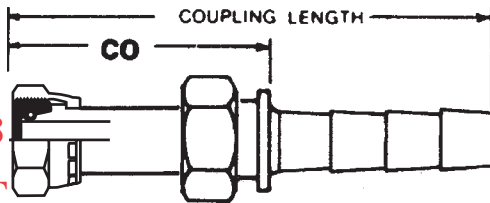

Part Number	Hose I.D.	Thread	DIN Tube O.D.(mm)	Nut Hex (mm)	Fitting Length	-CO-Cutoff
204-DL-612	1/4	12MM X 1.5	6	17	1.850	.940
204-DL-614	1/4	14MM X 1.5	8	17	1.811	.901
206-DL-616	3/8	16MM X 1.5	10	19	1.831	.921
206-DL-618	3/8	18MM X 1.5	12	22	1.870	.960
208-DL-622	1/2	22MM X 1.5	15	27	2.244	1.084
210-DL-626	5/8	26MM X 1.5	18	32	2.264	1.104

British Standard and Metric Stems - Heavy



SOLID MALE STEM DIN 20078 HEAVY 12° SEAT

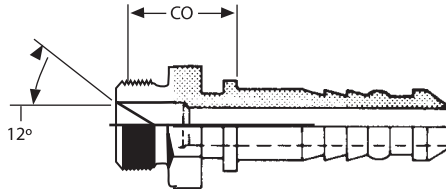

Part Number	Hose I.D.	Thread	Hex	Fitting Length	-CO-Cutoff
204-DH-116	1/4	16MM X 1.5	11/16	1.793	.883
204-DH-118	1/4	18MM X 1.5	3/4	1.793	.883
206-DH-120	3/8	20MM X 1.5	7/8	1.870	.960
206-DH-122	3/8	22MM X 1.5	7/8	1.910	1.000
208-DH-124	1/2	24MM X 1.5	1	2.272	1.112
210-DH-130	5/8	30MM X 2	1-3/16	2.303	1.143
412-DH-136	3/4	36MM X 2	1-1/2	3.231	1.376
416-DH-142	1	42MM X 2	1.3/4	3.615	1.565

METRIC SWIVEL FEMALE STEM DIN 20078 HEAVY 45° BENT TUBE W/ O-RING & 12/30° UNIV. CONE

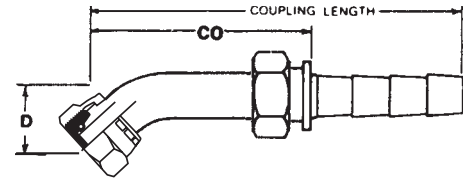

Part Number	Hose I.D.	Thread	DIN Tube O.D.(mm)	Nut Hex (mm)	-D-Drop	Fitting Length	-CO-Cutoff
204-DH-618 45	1/4	18MM X 1.5	10	22	.807	2.421	1.511
206-DH-620 45	3/8	20MM X 1.5	12	24	.984	2.815	1.905
206-DH-622 45	3/8	22MM X 1.5	14	27	.906	2.736	1.826
208-DH-624 45	1/2	24MM X 1.5	16	30	.945	3.150	1.990
210-DH-630 45	5/8	30MM X 2	20	36	1.240	3.622	2.462

METRIC SWIVEL FEMALE STEM DIN 20078 HEAVY STRAIGHT W/ O-RING & 12/30° UNIV. CONE

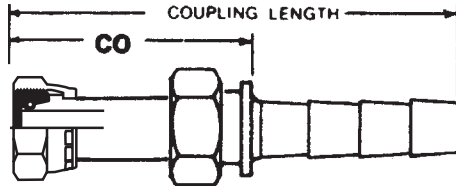

Part Number	Hose I.D.	Thread	DIN Tube O.D.(mm)	Nut Hex (mm)	Fitting Length	-CO-Cutoff
204-DH-616	1/4	16MM X 1.5	8	19	1.850	.940
204-DH-618	1/4	18MM X 1.5	10	22	1.890	.980
206-DH-618	3/8	18MM X 1.5	10	22	1.890	.980
206-DH-620	3/8	20MM X 1.5	12	24	2.106	1.196
206-DH-622	3/8	22MM X 1.5	14	27	1.969	1.059
208-DH-624	1/2	24MM X 1.5	16	30	2.165	1.005
210-DH-630	5/8	30MM X 2	20	36	2.520	1.360

METRIC SWIVEL FEMALE STEM DIN 20078 HEAVY 90° BENT TUBE W/ O-RING & 12/30° UNIV. CONE

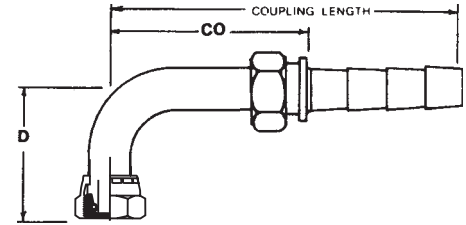

Part Number	Hose I.D.	Thread	DIN Tube O.D.(mm)	Nut Hex (mm)	-D-Drop	Fitting Length	-CO-Cutoff
204-DH-616 90	1/4	16MM X 1.5	8	19	1.378	1.929	1.019
204-DH-618 90	1/4	18MM X 1.5	10	22	1.437	1.929	1.019
206-DH-618 90	3/8	18MM X 1.5	10	22	1.594	2.244	1.334
206-DH-620 90	3/8	20MM X 1.5	12	24	1.811	2.244	1.334
206-DH-622 90	3/8	22MM X 1.5	14	27	1.693	2.244	1.334
208-DH-624 90	1/2	24MM X 1.5	16	30	1.831	2.717	1.557
210-DH-630 90	5/8	30MM X 2	20	36	2.461	3.071	1.911



1J

One-Piece Bite the Wire Fittings for SAE 100R1AT, 100R2AT, 100R16, 100R17, Hydra-Lite I & II, and Hydra-Max

**NPTF
SOLID
MALE
STEM**

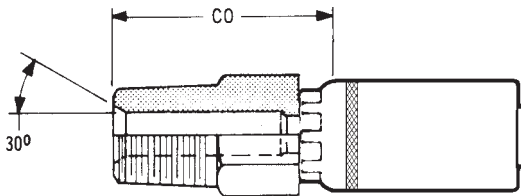

**SAE 45°
SOLID
MALE
STEM**

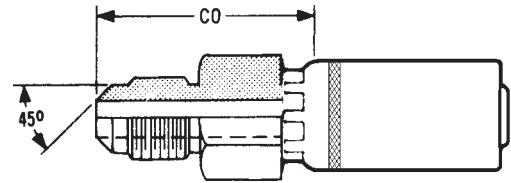

Part Number	Hose I.D.	Thread	Hex	Stem I.D.	Fitting Length	-CO-Cutoff
204-1J-102	1/4	1/8-27	5/8	.156	1.784	.874
204-1J-104	1/4	1/4-18	5/8	.156	1.940	1.030
204-1J-106	1/4	3/8-18	11/16	.156	1.940	1.030
204-1J-108	1/4	1/2-14	7/8	.156	2.175	1.265
206-1J-104	3/8	1/4-18	11/16	.296	1.971	1.061
206-1J-106	3/8	3/8-18	11/16	.296	1.971	1.061
206-1J-108	3/8	1/2-14	7/8	.296	2.222	1.312
208-1J-106	1/2	3/8-18	13/16	.406	2.472	1.312
208-1J-108	1/2	1/2-14	7/8	.406	2.472	1.312
208-1J-112	1/2	3/4-14	1-1/16	.406	2.534	1.374
210-1J-108	5/8	1/2-14	1-1/16	.500	2.534	1.374
210-1J-112	5/8	3/4-14	1-1/16	.500	2.534	1.374
212-1J-108	3/4	1/2-14	1-1/8	.625	2.614	1.364
212-1J-112	3/4	3/4-14	1-1/16	.625	2.676	1.526
212-1J-116	3/4	1 - 11-1/2	1-3/8	.625	2.926	1.676
216-1J-112	1	3/4-14	1-3/8	.717	2.922	1.452
216-1J-116	1	1 - 11-1/2	1-3/8	.843	3.172	1.702
220-1J-120	1-1/4	1-1/4 - 11-1/2	1-3/4	1.062	3.943	2.020

Part Number	Hose I.D.	Thread	Hex	Stem I.D.	Fitting Length	-CO-Cutoff
204-1J-303	1/4	3/8-24	5/8	.156	1.815	.905
204-1J-304	1/4	7/16-20	5/8	.156	1.878	.968
204-1J-305	1/4	1/2-20	5/8	.156	1.939	1.029
206-1J-306	3/8	5/8-18	11/16	.296	2.002	1.092
206-1J-308	3/8	3/4-16	11/16	.296	2.159	1.249
208-1J-308	1/2	3/4-16	13/16	.406	2.472	1.312
208-1J-310	1/2	7/8-14	7/8	.406	2.602	1.442
210-1J-310	5/8	7/8-14	1	.468	2.602	1.442
212-1J-312	3/4	1-1/16 - 14	1-1/8	.625	2.926	1.676

**SAE 45°
SWIVEL
FEMALE
STEM**

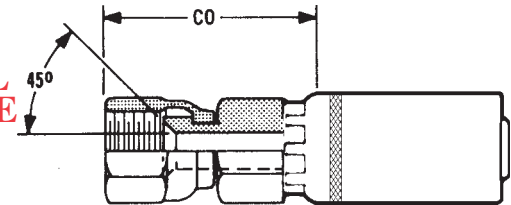

**NPTF
SWIVEL
MALE
STEM**

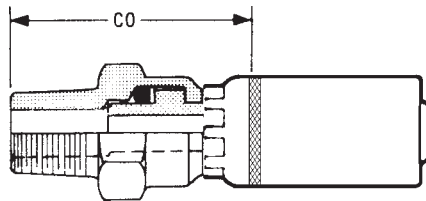

Leakage may occur at low pressure

Part Number	Hose I.D.	Thread	Nut Hex	Stem I.D.	Fitting Length	-CO-Cutoff
204-1J-202	1/4	1/8-27	1/2	.156	2.002	1.092
204-1J-204	1/4	1/4-18	11/16	.156	2.365	1.440
204-1J-206	1/4	3/8-18	13/16	.156	2.515	1.625
204-1J-208	1/4	1/2-14	7/8	.156	2.705	1.795
206-1J-204	3/8	1/4-18	11/16	.296	2.510	1.605
206-1J-206	3/8	3/8-18	13/16	.296	2.510	1.625
206-1J-208	3/8	1/2-14	7/8	.296	2.700	1.810
208-1J-206	1/2	3/8-18	1	.406	2.755	1.605
208-1J-208	1/2	1/2-14	1	.406	2.955	1.800
210-1J-212	5/8	3/4-14	1-5/16	.500	3.000	1.855
212-1J-208	3/4	1/2-14	1-5/16	.625	3.125	1.890
212-1J-212	3/4	3/4-14	1-5/16	.625	3.135	1.885
216-1J-216	1	1 - 11-1/2	1-5/8	.844	3.760	2.300
220-1J-220	1-1/4	1-1/4 - 11-1/2	1-3/4	.937	4.395	2.480

Part Number	Hose I.D.	Thread	Nut Hex	Stem Hex	Stem I.D.	Fitting Length	-CO-Cutoff
204-1J-404	1/4	7/16-20	5/8	9/16	.156	1.995	1.075
204-1J-405	1/4	1/2-20	5/8	11/16	.156	2.065	1.145
204-1J-406	1/4	5/8-18	5/8	3/4	.156	2.130	1.215
206-1J-404	3/8	7/16-20	11/16	9/16	.296	1.995	1.075
206-1J-406	3/8	5/8-18	11/16	3/4	.296	2.115	1.195
206-1J-408	3/8	3/4-16	11/16	7/8	.296	2.180	1.245
208-1J-406	1/2	5/8-18	13/16	3/4	.296	2.413	1.253
208-1J-408	1/2	3/4-16	13/16	7/8	.406	2.460	1.280
208-1J-410	1/2	7/8-14	13/16	1-1/16	.406	2.545	1.395
210-1J-410	5/8	7/8-14	1	1-1/16	.500	2.565	1.415
210-1J-412	5/8	1-1/16 - 14	1	1-1/4	.500	2.690	1.510
212-1J-410	3/4	7/8-14	1-1/16	1-1/16	.625	2.724	1.474
212-1J-412	3/4	1-1/16 - 14	1-1/16	1-1/4	.625	2.805	1.555

One-Piece Bite the Wire Fittings for SAE 100R1AT, 100R2AT, 100R16, 100R17, Hydra-Lite I & II, and Hydra-Max

1J



JIC 37° SOLID MALE STEM

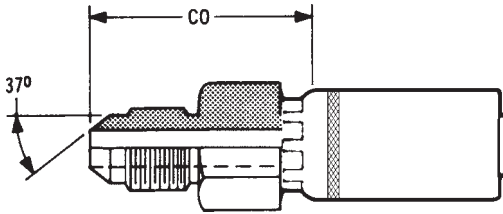

Part Number	Hose I.D.	Thread	Hex	Stem I.D.	Fitting Length	-CO-Cutoff
204-1J-504	1/4	7/16-20	5/8	.156	1.923	1.013
204-1J-505	1/4	1/2-20	5/8	.156	1.939	1.029
204-1J-506	1/4	9/16-18	5/8	.156	1.933	1.023
204-1J-507	1/4	5/8-18	5/8	.156	2.002	1.092
206-1J-506	3/8	9/16-18	11/16	.265	1.965	1.055
206-1J-508	3/8	3/4-16	3/4	.296	2.065	1.155
206-1J-510	3/8	7/8-14	7/8	.296	2.159	1.249
208-1J-508	1/2	3/4-16	13/16	.390	2.378	1.218
208-1J-510	1/2	7/8-14	7/8	.406	2.472	1.312
208-1J-512	1/2	1-1/16 - 12	1-1/16	.406	2.589	1.429
210-1J-508	5/8	3/4-16	1	.390	2.378	1.218
210-1J-510	5/8	7/8-14	1	.468	2.472	1.312
210-1J-512	5/8	1-1/16 - 12	1-1/16	.500	2.651	1.491
212-1J-510	3/4	7/8-14	1-1/16	.468	2.676	1.426
212-1J-512	3/4	1-1/16 - 12	1-1/8	.625	2.793	1.543
212-1J-514	3/4	1-3/16 - 12	1-1/4	.625	2.793	1.543
212-1J-516	3/4	1-5/16 - 12	1-3/8	.625	2.837	1.587
216-1J-516	1	1-5/16 - 12	1-5/8	.844	3.146	1.676
216-1J-520	1	1-5/8 - 12	1-5/8	.844	3.139	1.664
220-1J-520	1-1/4	1-5/8 - 12	1-3/4	1.062	3.932	1.993
220-1J-524	1-1/4	1-7/8 - 12	2	1.062	4.067	2.118

ORB SOLID MALE STEM

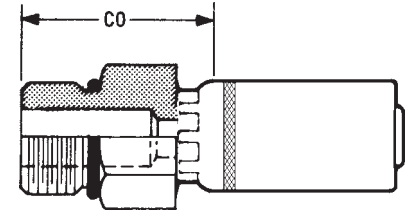

Part Number	Hose I.D.	Thread	Hex	Stem I.D.	Fitting Length	-CO-Cutoff
204-1J-704	1/4	7/16-20	5/8	.156	1.737	.827
204-1J-705	1/4	1/2-20	5/8	.156	1.737	.827
204-1J-706	1/4	9/16-18	11/16	.156	1.769	.859
206-1J-704	3/8	7/16-20	11/16	.250	1.769	.859
206-1J-705	3/8	1/2-20	11/16	.296	1.769	.859
206-1J-706	3/8	9/16-18	3/4	.296	1.862	.952
206-1J-708	3/8	3/4-16	7/8	.296	1.937	1.027
206-1J-710	3/8	7/8-14	1	.296	1.972	1.062
206-1J-712	3/8	1-1/16-12	1-1/4	.296	2.128	1.218
208-1J-708	1/2	3/4-16	7/8	.406	2.160	1.000
208-1J-710	1/2	7/8-14	1	.406	2.222	1.062
208-1J-712	1/2	1-1/16 - 12	1-1/4	.406	2.348	1.188
210-1J-708	5/8	3/4-16	1-1/8	.500	2.191	1.031
210-1J-710	5/8	7/8-14	1	.500	2.438	1.278
210-1J-712	5/8	1-1/16 - 12	1-1/4	.500	2.318	1.218
212-1J-710	3/4	7/8-14	1-1/16	.625	2.333	1.083
212-1J-712	3/4	1-1/16 - 12	1-1/4	.625	2.520	1.270
212-1J-714	3/4	1-3/16 - 12	1-3/8	.625	2.520	1.270
212-1J-716	3/4	1-5/16 - 12	1-1/2	.625	2.520	1.270
216-1J-712	1	1-1/16 - 12	1-3/8	.844	2.829	1.359
216-1J-714	1	1-3/16 - 12	1-3/8	.844	2.829	1.359
216-1J-716	1	1-5/16 - 12	1-1/2	.844	2.829	1.359
220-1J-720	1-1/4	1-5/8 - 12	1-3/4	1.062	3.568	1.646

JIC 37° SWIVEL FEMALE STEM

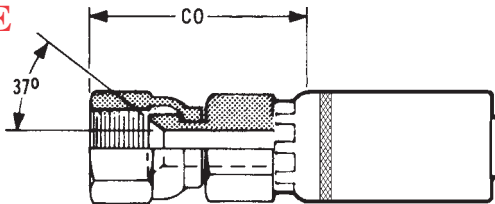

Part Number	Hose I.D.	Thread	Stem Hex	Nut Hex	Stem I.D.	Fitting Length	-CO-Cutoff
204-1J-604	1/4	7/16-20	5/8	9/16	.156	1.995	1.070
204-1J-605	1/4	1/2-20	5/8	11/16	.156	2.050	1.125
204-1J-606	1/4	9/16-18	5/8	3/4	.156	2.035	1.120
206-1J-604	1/4	7/16-20	11/16	9/16	.171	1.984	1.074
206-1J-606	3/8	9/16-18	11/16	3/4	.296	2.030	1.105
206-1J-608	3/8	3/4-16	11/16	7/8	.296	2.165	1.245
206-1J-610	3/8	7/8-14	13/16	1-1/16	.296	2.245	1.345
208-1J-606	1/2	9/16-18	13/16	3/4	.296	2.340	1.165
208-1J-608	1/2	3/4-16	13/16	7/8	.406	2.470	1.310
208-1J-610	1/2	7/8-14	13/16	1-1/16	.406	2.530	1.370
208-1J-612	1/2	1-1/16 - 12	1	1-1/4	.406	2.655	1.505
210-1J-608	5/8	3/4-16	1	7/8	.406	2.455	1.295
210-1J-610	5/8	7/8-14	1	1-1/16	.500	2.565	1.405
210-1J-612	5/8	1-1/16 - 12	1	1-1/4	.500	2.655	1.485
210-1J-614	5/8	1-3/16 - 12	1-1/8	1-3/8	.500	2.685	1.520
212-1J-610	3/4	7/8-14	1-1/16	1-1/16	.500	2.745	1.490
212-1J-612	3/4	1-1/16 - 12	1-1/16	1-1/4	.625	2.810	1.570
212-1J-614	3/4	1-3/16 - 12	1-1/8	1-3/8	.625	2.830	1.585
212-1J-616	3/4	1-5/16 - 12	1-1/4	1-1/2	.625	2.920	1.700
216-1J-612	1	1-1/16 - 12	1-3/8	1-1/4	.718	3.040	1.580
216-1J-614	1	1-3/16 - 12	1-3/8	1-3/8	.844	3.055	1.600
216-1J-616	1	1-5/16 - 12	1-3/8	1-1/2	.844	3.175	1.720
216-1J-620	1	1-5/8 - 12	1-1/2	2	.844	3.175	1.825
220-1J-620	1-1/4	1-5/8 - 12	1-3/4	2	1.062	4.155	2.195

ORB SWIVEL MALE STEM

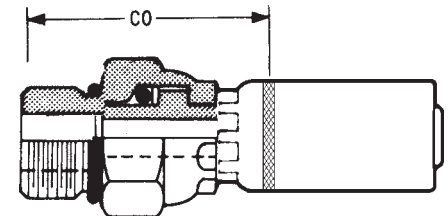

Leakage may occur at low pressure

Part Number	Hose I.D.	Thread	Nut Hex	Stem I.D.	Fitting Length	-CO-Cutoff
204-1J-805	1/4	1/2-20	11/16	.156	2.260	1.340
204-1J-806	1/4	9/16-18	11/16	.156	2.270	1.365
204-1J-808	1/4	3/4-16	7/8	.156	2.298	1.393
206-1J-806	3/8	9/16-18	11/16	.296	2.320	1.405
206-1J-808	3/8	3/4-16	7/8	.296	2.275	1.365
206-1J-810	3/8	7/8-14	1	.296	2.485	1.570
208-1J-808	1/2	3/4-16	1	.406	2.650	1.500
208-1J-810	1/2	7/8-14	1	.406	2.695	1.535
210-1J-810	5/8	7/8-14	1	.500	2.695	1.535
212-1J-812	3/4	1-1/16 - 12	1-5/16	.625	3.125	1.890
212-1J-814	3/4	1-3/16 - 12	1-5/16	.625	2.960	1.720



1J

One-Piece Bite the Wire Fittings for SAE 100R1AT, 100R2AT, 100R16, 100R17, Hydra-Lite I & II, and Hydra-Max

NPTF SOLID FEMALE STEM

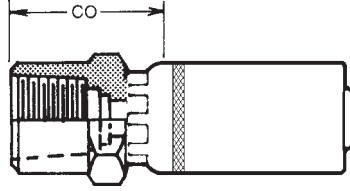

Part Number	Hose I.D.	Thread	Nut Hex	Stem I.D.	Fitting Length	-CO-Cutoff
204-1J-902	1/4	1/8-27	5/8	.156	1.784	.874
204-1J-904	1/4	1/4-18	11/16	.156	1.784	.874
204-1J-906	1/4	3/8-18	13/16	.156	1.972	1.782
206-1J-904	3/8	1/4-18	11/16	.296	1.784	.874
206-1J-906	3/8	3/8-18	13/16	.296	1.847	.937
206-1J-908	3/8	1/2-14	1	.296	2.050	1.140
208-1J-906	1/2	3/8-18	13/16	.406	2.050	1.140
208-1J-908	1/2	1/2-14	1	.406	2.300	1.140
212-1J-912	3/4	3/4-14	1-1/4	.625	2.676	1.426
216-1J-916	1	1 - 11-1/2	1-1/2	.844	3.031	1.561
220-1J-920	1-1/4	1-1/4 - 11-1/2	1-7/8	1.062	3.756	1.834

MALE "O"-LOK STEM

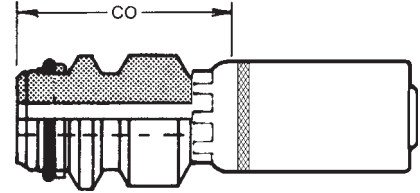

Part Number	Hose I.D.	Male Size	Stem I.D.	Fitting Length	-CO-Cutoff
204-1J-S04	1/4	1/4	.156	2.227	1.317
206-1J-S06	3/8	3/8	.296	2.227	1.317
208-1J-S08	1/2	1/2	.406	2.477	1.287
412-1J-S12	3/4	3/4	.625	2.619	1.369
416-1J-S16	1	1	.843	3.370	1.600
220-1J-S20	1-1/4	1-1/4	1.062	3.683	1.764

SOLID FEMALE GREASE FITTING STEM

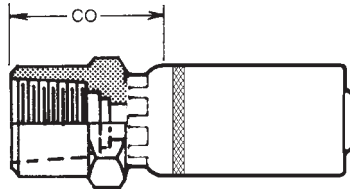

Part Number	Hose I.D.	Thread	Nut Hex	Stem I.D.	Fitting Length	-CO-Cutoff
204-1JSP-908	1/4	1/2-27	1-1/16	.156	1.784	.874
206-1JSP-908	3/8	1/2-27	1-1/16	.296	1.784	.874

NPSM SWIVEL FEMALE STEM

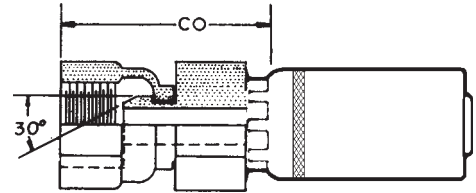

Part Number	Hose I.D.	Thread	Stem Hex	Nut Hex	Stem I.D.	Fitting Length	-CO-Cutoff
204-1J-4 FPX	1/4	1/4-18	5/8	11/16	.156	1.937	1.027
204-1J-6 FPX	1/4	3/8-18	5/8	7/8	.156	2.040	1.143
206-1J-4 FPX	3/8	1/4-18	11/16	11/16	.250	1.960	1.079
206-1J-6 FPX	3/8	3/8-18	11/16	7/8	.296	2.062	1.153
208-1J-8 FPX	1/2	1/2-14	13/16	1	.406	2.390	1.230
212-1J-12 FPX	3/4	3/4-14	1-1/16	1-1/4	.625	2.769	1.519
216-1J-16 FPX	1	1 - 11-1/2	1-3/8	1-1/2	.843	2.980	1.520
220-1J-20 FPX	1-1/4	1-1/4 - 11-1/2	1-3/4	1-7/8	1.062	4.054	1.705

45° SOLID FEMALE INVERTED FLARE STEM

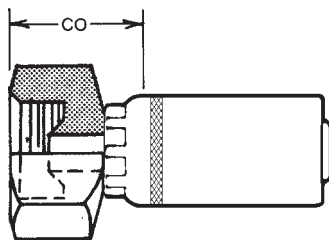

Part Number	Hose I.D.	Thread	Hex	Stem I.D.	Fitting Length	-CO-Cutoff
204-1J-904 IF	1/4	7/16-24	11/16	.156	1.597	.687
204-1J-905 IF	1/4	1/2-20	11/16	.156	1.597	.687
204-1J-906 IF	1/4	5/8-18	3/4	.156	1.597	.687
206-1J-906 IF	3/8	5/8-18	3/4	.296	1.532	.622

One-Piece Bite the Wire Fittings for SAE 100R1AT, 100R2AT, 100R16, 100R17, Hydra-Lite I & II, and Hydra-Max

1J



MALE FLARELESS STEM

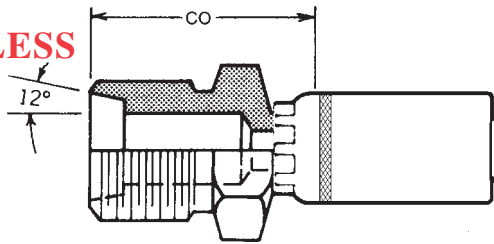

Part Number	Hose I.D.	Thread	Hex	Stem I.D.	Fitting Length	-CO-Cutoff
204-1J-E04	1/4	7/16-20	5/8	.156	1.831	.921
204-1J-E05	1/4	1/2-20				
204-1J-E06	1/4	9/16-18	5/8	.156	1.847	.937
206-1J-E05	3/8	1/2-20	11/16	.234	1.863	.953
206-1J-E06	3/8	9/16-18	11/16	.296	1.879	.969
206-1J-E08	3/8	3/4-16	13/16	.296	1.971	1.061
208-1J-E08	1/2	3/4-16	13/16	.406	2.285	1.125
208-1J-E10	1/2	7/8-14	1	.406	2.348	1.188

JIC 37° SWIVEL FEMALE STEM 45° BENT TUBE SHORT DROP

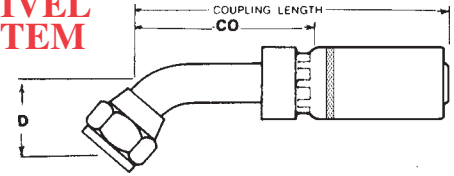

Part Number	Hose I.D.	Thread	Hex	-D-Drop	Fitting Length	-CO-Cutoff
204-1JS-684	1/4	7/16-20	9/16	.330	2.570	1.695
204-1JS-685	1/4	1/2-20	5/8	.360	2.670	1.795
204-1JS-686	1/4	9/16-18	11/16	.410	2.890	2.010
206-1JS-686	3/8	9/16-18	11/16	.410	2.890	2.015
206-1JS-688	3/8	3/4-16	7/8	.550	3.240	2.240
208-1JS-688	1/2	3/4-16	7/8	.550	3.240	2.303
208-1JS-690	1/2	7/8-14	1	.650	3.540	2.603
210-1JS-690	5/8	7/8-14	1	.650	3.750	2.620
210-1JS-692	5/8	1-1/16 - 12	1-1/4	.780	4.010	2.885
212-1JS-692	3/4	1-1/16 - 12	1-1/4	.780	4.020	2.895
212-1JS-694	3/4	1-3/16 - 12	1-3/8	.860	4.280	3.150
212-1JS-696	3/4	1-5/16 - 12	1-1/2	.890	4.430	3.300
216-1JS-692	1	1-1/16 - 12	1-1/4	.780	4.430	2.960
216-1JS-696	1	1-5/16 - 12	1-1/2	.890	4.430	2.960

SAE 45° SWIVEL FEMALE ONE-PIECE 45° BENT TUBE SHORT DROP

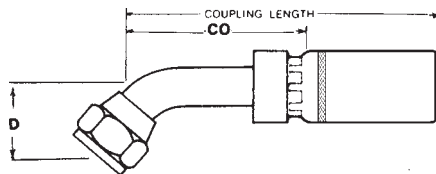

Part Number	Hose I.D.	Thread	Nut Hex	-D-Drop	Fitting Length	-CO-Cutoff
208-1JS-468	1/2	3/4-16	7/8	1.090	2.557	1.620

JIC 37° SWIVEL FEMALE STEM 45° BENT TUBE MEDIUM DROP

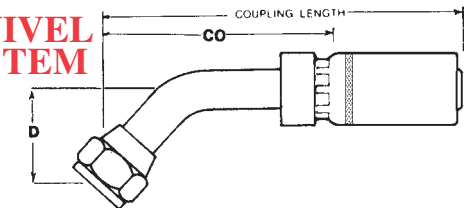

Part Number	Hose I.D.	Thread	Hex	-D-Drop	Fitting Length	-CO-Cutoff
204-1JM-684	1/4	7/16-20	9/16	.470	2.570	1.690
204-1JM-685	1/4	1/2-20	5/8	.590	2.670	1.790
204-1JM-686	1/4	9/16-18	11/16	.590	2.890	2.010
206-1JM-686	3/8	9/16-18	11/16	.590	2.890	2.015
206-1JM-688	3/8	3/4-16	7/8	.690	3.240	2.200
208-1JM-688	1/2	3/4-16	7/8	.690	3.240	2.303
208-1JM-690	1/2	7/8-14	1	.780	3.540	2.600
210-1JM-690	5/8	7/8-14	1	.780	3.750	2.620
210-1JM-692	5/8	1-1/16 - 12	1-1/4	1.060	4.010	2.885
212-1JM-690	3/4	7/8-14	1	.780	3.770	2.640
212-1JM-692	3/4	1-1/16 - 12	1-1/4	1.060	4.020	2.895
212-1JM-696	3/4	1-5/16 - 12	1-1/2	1.160	4.440	3.310
216-1JM-696	1	1-5/16 - 12	1-1/2	1.160	4.780	3.315
420-1JM-698	1-1/4	1-5/8 - 12	2	1.300	6.840	4.920

SAE 45° SWIVEL FEMALE ONE-PIECE 90° BENT TUBE MEDIUM DROP

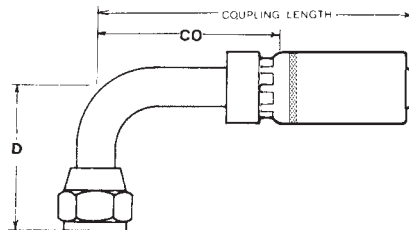

Part Number	Hose I.D.	Thread	Nut Hex	-D-Drop	Fitting Length	-CO-Cutoff
204-1JM-464	1/4	7/16-20	9/16	.880	2.300	1.425
206-1JM-466	3/8	5/8-18	3/4	1.160	2.640	1.765

JIC 37° SWIVEL FEMALE STEM 45° BENT TUBE LONG DROP

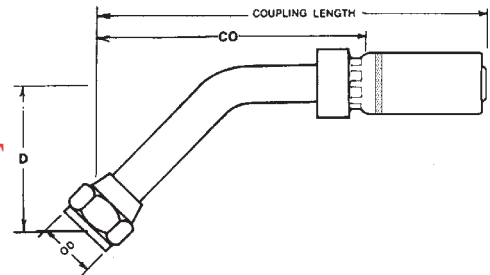

Part Number	Hose I.D.	Thread	Nut Hex	-D-Drop	Fitting Length	-CO-Cutoff
208-1JL-688	1/2	3/4-16	7/8	.700	3.400	2.500
208-1JL-690	1/2	7/8-14	1	.880	3.640	2.700
216-1JL-696	1	1-5/16 - 12	1-1/2	1.330	4.960	3.490



1J

One-Piece Bite the Wire Fittings for SAE 100R1AT, 100R2AT, 100R16, 100R17, Hydra-Lite I & II, and Hydra-Max

JIC 37° SWIVEL FEMALE STEM 90° BENT TUBE SHORT DROP

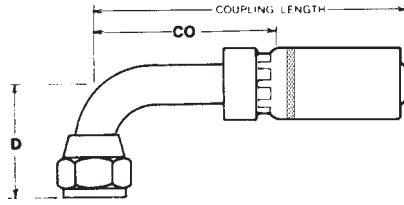

Part Number	Hose I.D.	Thread	Nut Hex	-D-Drop	Fitting Length	-CO-Cutoff
204-1JS-664	1/4	7/16-20	9/16	.780	2.300	1.425
204-1JS-665	1/4	1/2-20	5/8	.900	2.390	1.510
204-1JS-666	1/4	9/16-18	11/16	.920	2.540	1.665
206-1JS-666	3/8	9/16-18	11/16	.920	2.540	1.670
206-1JS-668	3/8	3/4-16	7/8	1.170	2.635	1.755
208-1JS-668	1/2	3/4-16	7/8	1.170	2.697	1.760
208-1JS-670	1/2	7/8-14	1	1.320	3.060	2.123
210-1JS-670	5/8	7/8-14	1	1.320	3.260	2.135
210-1JS-672	5/8	1-1/16 - 12	1-1/4	1.870	3.860	2.730
212-1JS-670	3/4	7/8-14	1	1.320	3.290	2.160
212-1JS-672	3/4	1-1/16 - 12	1-1/4	1.870	3.880	2.755
212-1JS-674	3/4	1-3/16 - 12	1-3/8	2.000	4.250	3.120
212-1JS-676	3/4	1-5/16 - 12	1-1/2	2.240	4.375	3.250
216-1JS-676	1	1-5/16 - 12	1-1/2	2.240	4.720	3.250
420-1JS-678	1-1/4	1-5/8 - 12	1-1/2	3.500	6.840	4.920

JIC 37° SWIVEL FEMALE STEM 90° BENT TUBE LONG DROP

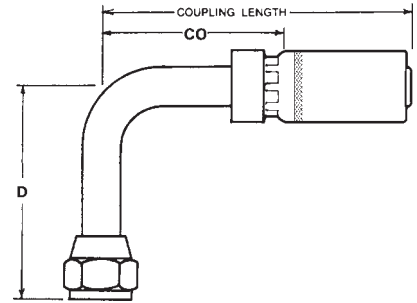

Part Number	Hose I.D.	Thread	Nut Hex	-D-Drop	Fitting Length	-CO-Cutoff
204-1JL-664	1/4	7/16-20	9/16	1.800	2.300	1.425
204-1JL-665	1/4	1/2-20	5/8	1.800	2.390	1.515
204-1JL-666	1/4	9/16-18	11/16	2.180	2.550	1.675
206-1JL-666	3/8	9/16-18	11/16	2.180	2.540	1.670
206-1JL-668	3/8	3/4-16	7/8	2.430	2.760	1.885
208-1JL-668	1/2	3/4-16	7/8	2.430	2.760	1.823
208-1JL-670	1/2	7/8-14	1	2.570	3.060	2.123
208-1JL-672	1/2	1-1/16-12	1-1/4	3.730	3.670	2.730
210-1JL-670	5/8	7/8-14	1	2.570	3.220	2.135
210-1JL-672	5/8	1-1/16 - 12	1-1/4	3.730	3.860	2.730
212-1JL-672	3/4	1-1/16 - 12	1-1/4	3.730	3.880	2.755
212-1JL-674	3/4	1-3/16 - 12	1-3/8	3.930	4.010	2.885
212-1JL-676	3/4	1-5/16 - 12	1-1/2	4.330	4.370	3.240
216-1JL-674	1	1-3/16 - 12	1-3/8	3.930	4.370	2.890
216-1JL-676	1	1-5/16 - 12	1-1/2	4.330	4.720	3.250

JIC 37° SWIVEL FEMALE STEM 90° BENT TUBE MEDIUM DROP

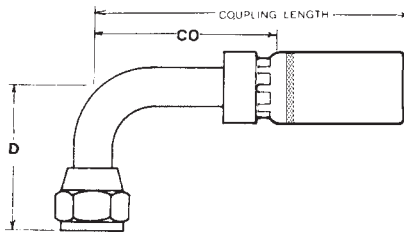

Part Number	Hose I.D.	Thread	Nut Hex	-D-Drop	Fitting Length	-CO-Cutoff
204-1JM-664	1/4	7/16-20	9/16	.880	2.300	1.425
204-1JM-665	1/4	1/2-20	5/8	1.130	2.390	1.515
204-1JM-666	1/4	9/16-18	11/16	1.130	2.540	1.670
206-1JM-666	3/8	9/16-18	11/16	1.130	2.540	1.670
206-1JM-668	3/8	3/4-16	7/8	1.380	2.760	1.885
208-1JM-668	1/2	3/4-16	7/8	1.380	2.760	1.823
208-1JM-670	1/2	7/8-14	1	1.750	3.060	2.123
210-1JM-670	5/8	7/8-14	1	1.750	3.260	2.135
210-1JM-672	5/8	1-1/16 - 12	1-1/4	2.060	3.860	2.730
212-1JM-670	3/4	7/8-14	1	1.750	3.290	2.160
212-1JM-672	3/4	1-1/16 - 12	1-1/4	2.060	3.880	2.755
212-1JM-676	3/4	1-5/16 - 12	1-3/8	2.620	4.370	3.240
216-1JM-676	1	1-5/16 - 12	1-3/8	2.620	4.720	3.250
216-1JM-678	1	1-5/8 - 12	1-1/2	3.400	5.850	4.400
420-1JM-678	1-1/4	1-5/8 - 12	1-1/2	3.500	6.840	4.920

JIC 37° SWIVEL FEMALE STEM 30° BENT TUBE SHORT DROP

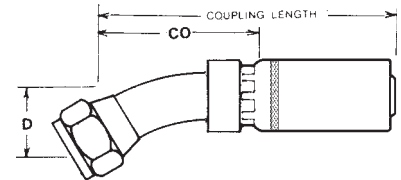

Part Number	Hose I.D.	Thread	Nut Hex	-D-Drop	Fitting Length	-CO-Cutoff
210-1JS-622	5/8	1-1/16 - 12	1-1/4	.480	3.620	2.49

SAE 45° MALE INVERTED SWIVEL STEM STRAIGHT TUBE

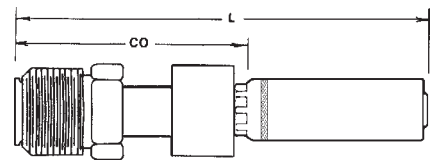

Part Number	Hose I.D.	Thread	Nut Hex	Fitting Length	-CO-Cutoff
204-1J-B03	1/4	3/8-24	3/8	2.380	1.505
204-1J-B04	1/4	7/16-24	7/16	2.440	1.565
204-1J-B05	1/4	1/2-20	1/2	2.560	1.685
206-1J-B04	3/8	7/16-24	7/16	2.440	1.565
206-1J-B05	3/8	1/2-20	1/2	2.560	1.685
206-1J-B06	3/8	5/8-18	5/8	2.600	1.725
206-1J-B07	3/8	11/16-18	11/16	2.680	1.805
206-1J-B08	3/8	3/4-18	3/4	2.800	1.925
208-1J-B06	1/2	5/8-18	5/8	2.660	1.723
208-1J-B08	1/2	3/4-18	3/4	2.860	1.923
208-1J-B10	1/2	7/8-18	7/8	2.920	1.983

One-Piece Bite the Wire Fittings for SAE 100R1AT, 100R2AT, 100R16, 100R17, Hydra-Lite I & II, and Hydra-Max

1J



SAE 45° MALE INVERTED SWIVEL STEM 45° BENT TUBE

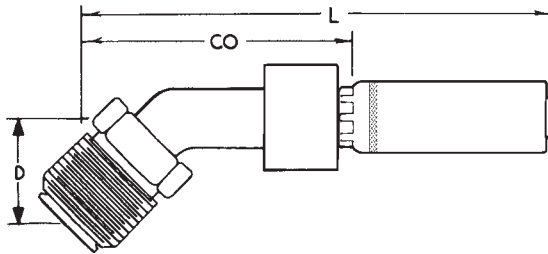

Part Number	Hose I.D.	Thread	Nut Hex	-D-Drop	Fitting Length	-CO-Cutoff
204-1J-B43	1/4	3/8-24	3/8	.530	2.490	1.615
204-1J-B44	1/4	7/16-24	7/16	.570	2.660	1.780
204-1J-B45	1/4	1/2-20	1/2	.650	2.850	1.975
206-1J-B44	3/8	7/16-24	7/16	.570	2.660	1.780
206-1J-B45	3/8	1/2-20	1/2	.650	2.850	1.975
206-1J-B46	3/8	5/8-18	5/8	.710	3.000	2.125
206-1J-B47	3/8	11/16-18	11/16	.760	3.126	2.240
206-1J-B48	3/8	3/4-18	3/4	.850	3.330	2.450
208-1J-B48	1/2	3/4-18	3/4	.850	3.390	2.515
208-1J-B50	1/2	7/8-18	7/8	.960	3.600	2.660

SOLID MALE FLAT FACE "O" RING SEAL STEM

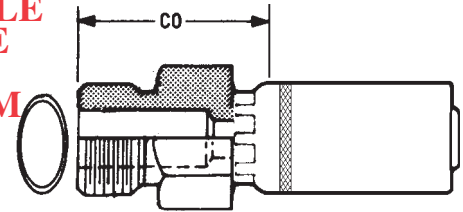

Part Number	Hose I.D.	Thread	Hex	Stem I.D.	Fitting Length	-CO-Cutoff	"O" Ring Part No.
204-1JFS-04	1/4	9/16-18	5/8	.156	1.764	.850	4 ORFS
204-1JFS-06	1/4	11/16-16	3/4	.156	1.850	.940	6 ORFS
206-1JFS-04	3/8	6/16-18	3/4	.265	1.858	.948	4 ORFS
206-1JFS-06	3/8	11/16-16	3/4	.265	1.850	.940	6 ORFS
206-1JFS-08	3/8	13/16-16	7/8	.265	1.976	1.066	8 ORFS
208-1JFS-06	1/2	11/16-16	7/8	.375	2.163	1.003	6 ORFS
208-1JFS-08	1/2	13/16-16	7/8	.375	2.226	1.065	8 ORFS
208-1JFS-10	1/2	1-14	1	.406	2.363	1.203	10 ORFS
210-1JFS-08	5/8	13/16-16	1-1/16	.482	2.257	1.097	8 ORFS
210-1JFS-10	5/8	1-14	1-1/16	.500	2.394	1.235	10 ORFS
210-1JFS-12	5/8	1-13/16-12	1-1/4	.482	2.485	1.325	12 ORFS
412-1JFS-10	3/4	1-14	1-1/4	.609	3.141	1.286	10 ORFS
412-1JFS-12	3/4	1-3/16-12	1-1/4	.609	3.201	1.345	12 ORFS
416-1JFS-16	1	1-7/16-12	1-1/2	.812	3.504	1.455	16 ORFS
220-1JFS-20	1-1/4	1-11/16-12	1-3/4	1.046	3.663	1.740	20 ORFS

SAE 45° MALE INVERTED SWIVEL STEM 90° BENT TUBE

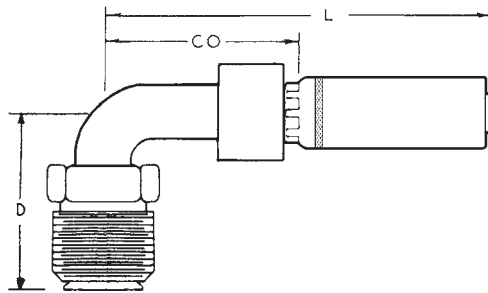

Part Number	Hose I.D.	Thread	Nut Hex	-D-Drop	Fitting Length	-CO-Cutoff
204-1J-B63	1/4	3/8-24	3/8	.970	2.180	1.300
204-1J-B64	1/4	7/16-24	7/16	1.100	2.380	1.505
204-1J-B65	1/4	1/2-20	1/2	1.280	2.560	1.680
206-1J-B64	3/8	7/16-24	7/16	1.100	2.380	1.500
206-1J-B65	3/8	1/2-20	1/2	1.280	2.560	1.680
206-1J-B66	3/8	5/8-18	5/8	1.450	2.730	1.855
206-1J-B67	3/8	11/16-18	11/16	1.600	2.880	2.005
206-1J-B68	3/8	3/4-18	3/4	1.780	3.060	2.180
208-1J-B68	1/2	3/4-18	3/4	1.780	3.120	2.185
208-1J-B70	1/2	7/8-18	7/8	2.090	3.370	2.430

SWIVEL FEMALE FLAT FACE "O" RING SEAL STEM STRAIGHT

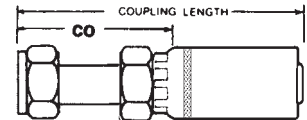

Part Number	Hose I.D.	Thread	Stem Hex	Nut Hex	Fitting Length	-CO-Cutoff
204-1JFSX-04	1/4	9/16-18	5/8	11/16	1.702	.792
204-1JFSX-06	1/4	11/16-16	5/8	13/16	1.727	.817
206-1JFSX-06	3/8	11/16-16	11/16	13/16	1.727	.817
206-1JFSX-08	3/8	13/16-16	3/4	15/16	1.764	.854
208-1JFSX-06	1/2	11/16-16	7/8	13/16	1.977	.817
208-1JFSX-08	1/2	13/16-16	13/16	15/16	2.062	.902
208-1JFSX-10	1/2	1-14	7/8	1-1/8	2.079	.919
208-1JFSX-12	1/2	1-3/16-12	1-1/8	1-3/8	2.092	.932
210-1JFSX-10	5/8	1-14	1	1-1/8	2.127	.967
210-1JFSX-12	5/8	1-3/16-12	1-1/8	1-3/8	2.140	.980
412-1JFSX-08	3/4	13/16-16	1-1/16	15/16	2.856	1.001
412-1JFSX-10	3/4	1-14	1-1/16	1-1/8	2.874	1.019
412-1JFSX-12	3/4	1-3/16-12	1-1/16	1-3/8	2.887	1.032
416-1JFSX-16	1	1-7/16-12	1-3/8	1-5/8	3.022	1.167
416-1JFSX-16	1	1-7/16-12	1-3/8	1-5/8	3.243	1.193
220-1JFSX-20	1-1/4	1-11/16-12	1-3/4	1-7/8	4.090	2.167



1J

One-Piece Bite the Wire Fittings for SAE 100R1AT, 100R2AT, 100R16, 100R17, Hydra-Lite I & II, and Hydra-Max

SWIVEL FEMALE FLAT FACE "O" RING SEAL STEM 45°

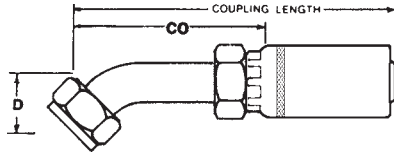

Part Number	Hose I.D.	Thread	Nut Hex	-D-Drop	Fitting Length	-CO-Cutoff
204-1JFSX-L64	1/4	9/16-18	11/16	.410	2.450	1.575
206-1JFSX-L66	3/8	11/16-16	13/16	.430	2.750	1.840
206-1JFSX-L68	3/8	13/16-16	15/16	.590	3.100	2.190
208-1JFSX-L68	1/2	13/16-16	15/16	.590	3.350	2.190
210-1JFSX-L70	5/8	1 - 14	1-1/8	.650	3.750	2.590
412-1JFSX-L72	3/4	1-3/16-12	1-3/8	.830	4.525	2.670
416-1JFSX-L76	1	1-7/16 - 12	1-5/8	.940	5.625	3.575
220-1JFSX-L80	1-1/4	1-11/16 - 12	1-7/8	1.000	5.930	4.007

SWIVEL FEMALE FLAT FACE "O" RING SEAL STEM 90° MEDIUM DROP

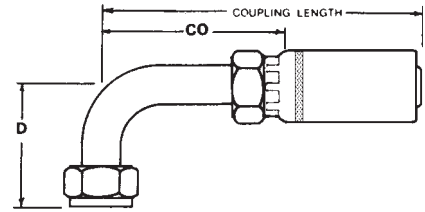

Part Number	Hose I.D.	Thread	Nut Hex	-D-Drop	Fitting Length	-CO-Cutoff
204-1JFSX-J34	1/4	9/16-18	11/16	1.260	2.450	1.550
204-1JFSX-J36	1/4	11/16-16	13/16	1.500	2.850	1.985
206-1JFSX-J36	3/8	11/16-16	13/16	1.500	2.850	1.940
208-1JFSX-J38	1/2	13/16-16	15/16	1.620	3.425	2.300
208-1JFSX-J40	1/2	1 - 14	1-1/8	1.850	3.240	2.319
210-1JFSX-J40	5/8	1 - 14	1-1/8	1.850	3.550	2.350
412-1JFSX-J42	3/4	1-3/16 - 12	1-3/8	2.280	4.575	2.720
416-1JFSX-J46	1	1-7/16 - 12	1-5/8	2.780	5.625	3.550
220-1JFSX-J50	1-1/4	1-11/16 - 12	1-7/8	3.090	5.925	4.025

SWIVEL FEMALE FLAT FACE "O" RING SEAL STEM 90° SHORT DROP

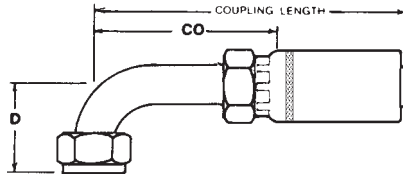

Part Number	Hose I.D.	Thread	Nut Hex	-D-Drop	Fitting Length	-CO-Cutoff
204-1JFSX-A24	1/4	9/16-18	11/16	.820	2.425	1.550
206-1JFSX-A26	3/8	11/16-16	13/16	.900	2.750	1.840
206-1JFSX-A28	3/8	13/16-16	15/16	1.150	3.170	2.230
208-1JFSX-A28	1/2	13/16-16	15/16	1.150	2.260	2.215
208-1JFSX-A30	1/2	1 - 14	1-1/8	1.490	3.010	1.850
208-1JFSX-A32	1/2	1-3/16 - 12	1-3/8	1.895	4.000	2.840
210-1JFSX-A30	5/8	1 - 14	1-1/8	1.490	3.400	2.250
210-1JFSX-A32	5/8	1-3/16 - 12	1-3/8	1.895	4.000	2.830
412-1JFSX-A32	3/4	1-3/16 - 12	1-3/8	1.880	4.705	2.850
416-1JFSX-A36	1	1-7/16 - 12	1-5/8	2.200	5.875	3.825
220-1JFSX-A40	1-1/4	1-11/16 - 12	1-7/8	2.500	5.825	3.902

SWIVEL FEMALE FLAT FACE "O" RING SEAL STEM 90° LONG DROP

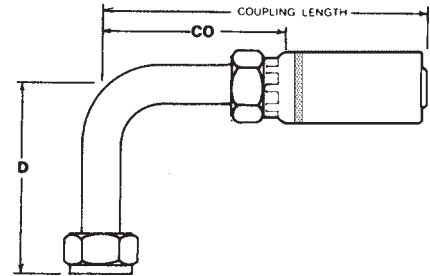

Part Number	Hose I.D.	Thread	Nut Hex	-D-Drop	Fitting Length	-CO-Cutoff
204-1JFSX-A64	1/4	9/16-18	11/16	1.800	2.450	1.575
206-1JFSX-A66	3/8	11/16-16	13/16	2.130	2.875	1.965
208-1JFSX-A68	1/2	13/16-16	15/16	2.500	3.450	2.300
210-1JFSX-A70	5/8	1 - 14	1-1/8	2.750	3.730	2.600
412-1JFSX-A72	3/4	1-3/16 - 12	1-3/8	3.780	4.550	2.750
416-1JFSX-A76	1	1-7/16 - 12	1-5/8	4.500	5.590	3.540
220-1JFSX-A80	1-1/4	1-11/16 - 12	1-7/8	5.090	5.875	3.975

One-Piece Bite the Wire British Standard Fittings for SAE 100R1AT, 100R2AT, 100R16, 100R17, Hydra-Lite I & II and Hydra-Max

1J



BRITISH STANDARD PARALLEL PIPE BSPP SOLID MALE STEM 30° SEAT

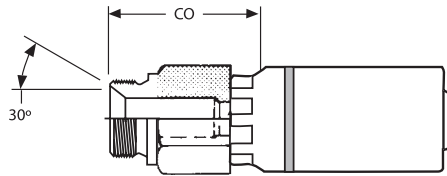

Part Number	Hose I.D.	Thread	Hex	Fitting Length	-CO-Cutoff
204-1JBP-104	1/4	1/4-19	3/4	1.891	.981
206-1JBP-106	3/8	3/8-19	7/8	1.981	1.071
208-1JBP-108	1/2	1/2-14	1-1/16	2.392	1.232
412-1JBP-112	3/4	3/4-14	1-1/4	3.281	1.426
416-1JBP-116	1	1-11	1-5/8	3.645	1.595

BSPP SWIVEL FEMALE STEM 30° CONE 45° BENT TUBE

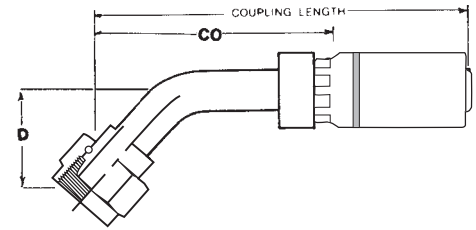

Part Number	Hose I.D.	Thread	Nut Hex	-D-Drop	Fitting Length	-CO-Cutoff
204-1JBPX-4 45	1/4	1/4-19	11/16	.500	2.565	1.690
204-1JBPX-6 45	1/4	3/8-19	7/8	.625	2.885	2.010
206-1JBPX-6 45	3/8	3/8-19	7/8	.625	2.885	2.010
208-1JBPX-8 45	1/2	1/2-14	1	.750	3.137	2.200
210-1JBPX-10 45	5/8	5/8-14	1-1/16	.875	3.745	2.620
210-1JBPX-12 45	5/8	3/4-14	1-1/4	1.125	3.875	2.750
412-1JBPX-12 45	3/4	3/4-14	1-1/4	1.125	4.755	2.900
416-1JBPX-16 45	1	1-11	1-1/2	1.250	5.360	3.310

JIS SWIVEL FEMALE STEM 30° SEAT

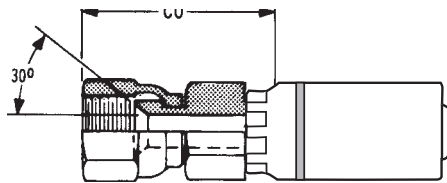

Part Number	Hose I.D.	Thread	Nut Hex	Stem Hex	Fitting Length	-CO-Cutoff
204-1JBP-604	1/4	1/4-19	11/16	5/8	1.937	1.027
206-1JBP-606	3/8	3/8-19	7/8	11/16	2.033	1.123
208-1JBP-608	1/2	1/2-14	1	13/16	2.378	1.218
412-1JBP-612	3/4	3/4-14	1-1/4	1-1/16	3.344	1.489
416-1JBP-616	1	1-11	1-1/2	1-3/8	3.565	1.515
220-1JBP-620	1-1/4	1-1/4-11	1-7/8	1-3/4	4.036	2.114

BSPP SWIVEL FEMALE STEM 30° CONE 90° BENT TUBE

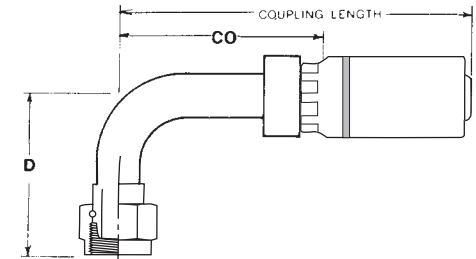

Part Number	Hose I.D.	Thread	Nut Hex	-D-Drop	Fitting Length	-CO-Cutoff
204-1JBPX-4 90	1/4	1/4-19	11/16	1.625	2.390	1.515
206-1JBPX-6 90	3/8	3/8-19	7/8	1.625	2.540	1.665
208-1JBPX-8 90	1/2	1/2-14	1	1.750	2.817	1.880
208-1JBPX-10 90	1/2	5/8-14	1-1/16	2.000	3.057	2.120
210-1JBPX-10 90	5/8	5/8-14	1-1/16	2.000	3.265	2.140
210-1JBPX-12 90	5/8	3/4-14	1-1/4	2.250	3.265	2.140
412-1JBPX-12 90	3/4	3/4-14	1-1/4	2.250	4.610	2.755
416-1JBPX-16 90	1	1-11	1-1/2	2.250	4.940	2.890
220-1JBPX-20 90	1-1/4	1-1/4-11	1-7/8	4.500	6.843	4.920

BRITISH STANDARD PARALLEL PIPE BSPP SWIVEL FEMALE STEM 30° CONE

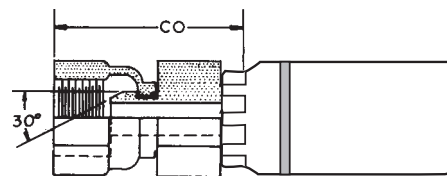

Part Number	Hose I.D.	Thread	Nut Hex	Stem Hex	Fitting Length	-CO-Cutoff
204-1JBPX-4	1/4	1/4-19	11/16	5/8	1.939	1.029
204-1JBPX-6	1/4	3/8-19	7/8	5/8	2.033	1.123
206-1JBPX-6	3/8	3/8-19	7/8	11/16	2.033	1.123
206-1JBPX-8	3/8	1/2-14	1	13/16	2.127	1.217
208-1JBPX-8	1/2	1/2-14	1	13/16	2.377	1.217
208-1JBPX-10	1/2	5/8-14	1-1/16	13/16	2.464	1.304
210-1JBPX-10	5/8	5/8-14	1-1/16	1	2.543	1.383
210-1JBPX-12	5/8	3/4-14	1-1/4	1	2.628	1.468
412-1JBPX-12	3/4	3/4-14	1-1/4	1-1/16	3.344	1.489
416-1JBPX-16	1	1-11	1-1/2	1-3/8	3.565	1.515
220-1JBPX-20	1-1/4	1-1/4-11	1-7/8	1-3/4	4.036	2.114

BRITISH STANDARD TAPERED PIPE BSPT SOLID MALE STEM 30° SEAT

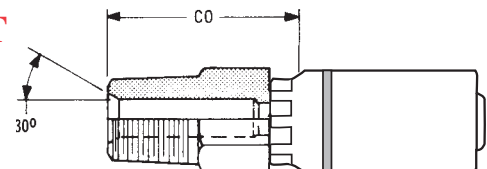

Part Number	Hose I.D.	Thread	Hex	Fitting Length	-CO-Cutoff
204-1JBT-104	1/4	1/4-19	5/8	1.875	.965
204-1JBT-106	1/4	3/8-19	11/16	1.875	.965
206-1JBT-106	3/8	3/8-19	11/16	1.906	.996
208-1JBT-108	1/2	1/2-14	7/8	2.316	1.156
412-1JBT-112	3/4	3/4-14	1-1/16	3.197	1.342
416-1JBT-116	1	1-11	1-3/8	3.603	1.553



1J

One-Piece Bite the Wire British Standard Fittings for SAE 100R1AT, 100R2AT, 100R16, 100R17, Hydra-Lite I & II and Hydra-Max

KOMATSU SWIVEL FEMALE STEM 30° SEAT

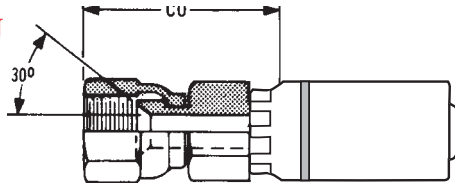

Part Number	Hose I.D.	Thread	Nut Hex	Stem Hex	Fitting Length	-CO-Cutoff
204-1JKU-614	1/4	14MM X 1.5	3/4	5/8	2.035	1.125
204-1JKU-618	1/4	18MM X 1.5	7/8	11/16	2.158	1.248
206-1JKU-618	3/8	18MM X 1.5	7/8	11/16	2.158	1.248
208-1JKU-622	1/2	22MM X 1.5	1-1/16	13/16	2.545	1.385
208-1JKU-624	1/2	24MM X 1.5	1-1/4	1	2.631	1.471
210-1JKU-624	5/8	24MM X 1.5	1-1/4	1	2.662	1.502
412-1JKU-630	3/4	30MM X 1.5	1-1/2	1-1/4	3.584	1.729
416-1JKU-633	1	33MM X 1.5	1-5/8	1-3/8	3.805	1.755
220-1JKU-636	1-1/4	36MM X 1.5	1-3/4	1-3/4	4.198	2.276
224-1JKU-642	1-1/2	42MM X 1.5	2-1/4	2	4.795	2.457

METRIC SWIVEL FEMALE STEM DIN 20078 LIGHT 45° BENT TUBE W/ O-RING

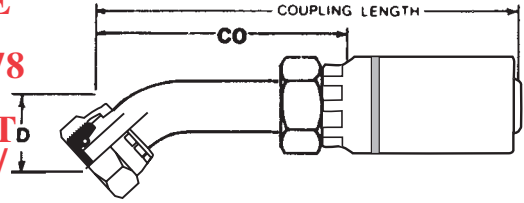

Part Number	Hose I.D.	Thread	DIN Tube O.D.(mm)	Nut Hex (mm)	-D-Drop	Fitting Length	-CO-Cutoff
206-1JDL-616 45	3/8	16MM X 1.5	10	19	.827	2.638	1.728
206-1JDL-618 45	3/8	18MM X 1.5	12	22	.846	2.677	1.767
208-1JDL-622 45	1/2	22MM X 1.5	15	27	.984	3.189	2.029

SOLID MALE STEM DIN 20078 LIGHT 12° SEAT

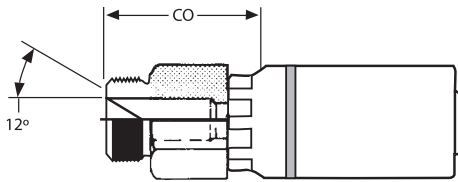

Part Number	Hose I.D.	Thread	Hex	Fitting Length	-CO-Cutoff
204-1JDL-112	1/4	12MM X 1.5	1/2	1.793	.883
204-1JDL-114	1/4	14MM X 1.5	5/8	1.793	.883
206-1JDL-116	3/8	16MM X 1.5	11/16	1.824	.914
206-1JDL-118	3/8	18MM X 1.5	3/4	1.824	.914
208-1JDL-122	1/2	22MM X 1.5	7/8	2.222	1.062
210-1JDL-126	5/8	26MM X 1.5	1-1/16	2.253	1.093
412-1JDL-126	3/4	26MM X 1.5	1-1/16	3.031	1.176
412-1JDL-130	3/4	30MM X 2	1-1/4	3.081	1.226

METRIC SWIVEL FEMALE STEM DIN 20078 LIGHT 90° BENT TUBE W/ O-RING

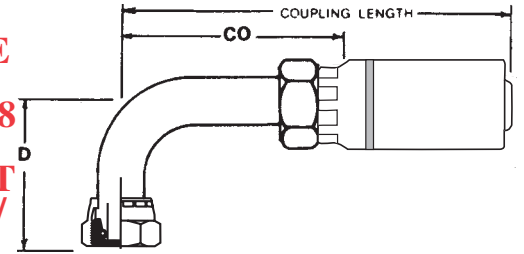

Part Number	Hose I.D.	Thread	DIN Tube O.D.(mm)	Nut Hex (mm)	-D-Drop	Fitting Length	-CO-Cutoff
204-1JDL-614 90	1/4	14MM X 1.5	8	17	1.378	1.929	1.019
206-1JDL-616 90	3/8	16MM X 1.5	10	19	1.575	2.244	1.334
206-1JDL-618 90	3/8	18MM X 1.5	12	22	1.614	2.244	1.334
208-1JDL-622 90	1/2	22MM X 1.5	15	27	1.890	2.717	1.557
210-1JDL-626 90	5/8	26MM X 1.5	18	32	2.185	3.071	1.911

METRIC SWIVEL FEMALE STEM DIN 20078 LIGHT STRAIGHT W/ O-RING

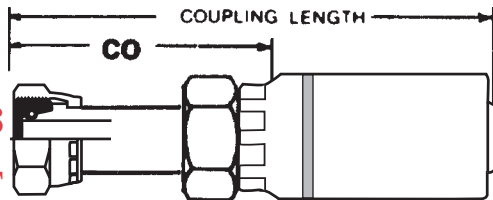

Part Number	Hose I.D.	Thread	DIN Tube O.D.(mm)	Nut Hex (mm)	Fitting Length	-CO-Cutoff
204-1JDL-612	1/4	12MM X 1.5	6	17	1.850	.940
204-1JDL-614	1/4	14MM X 1.5	8	17	1.811	.901
206-1JDL-616	3/8	16MM X 1.5	10	19	1.831	.921
206-1JDL-618	3/8	18MM X 1.5	12	22	1.870	.960
208-1JDL-622	1/2	22MM X 1.5	15	27	2.244	1.084
210-1JDL-626	5/8	26MM X 1.5	18	32	2.264	1.104

One-Piece Bite the Wire British Standard Fittings for SAE 100R1AT, 100R2AT, 100R16, 100R17, Hydra-Lite I & II and Hydra-Max

1J



SOLID MALE STEM DIN 20078 HEAVY 12° SEAT

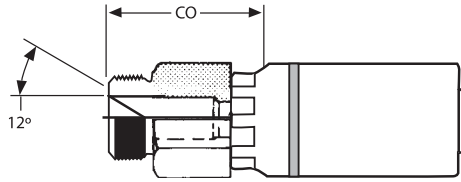

Part Number	Hose I.D.	Thread	Hex	Fitting Length	-CO-Cutoff
204-1JDH-116	1/4	16MM X 1.5	11/16	1.793	.883
204-1JDH-118	1/4	18MM X 1.5	3/4	1.793	.883
206-1JDH-120	3/8	20MM X 1.5	7/8	1.870	.960
206-1JDH-122	3/8	22MM X 1.5	7/8	1.910	1.000
208-1JDH-124	1/2	24MM X 1.5	1	2.272	1.112
210-1JDH-130	5/8	30MM X 2	1-3/16	2.303	1.143
412-1JDH-136	3/4	36MM X 2	1-1/2	3.231	1.376
416-1JDH-142	1	42MM X 2	1.3/4	3.615	1.565

METRIC SWIVEL FEMALE STEM DIN 20078 HEAVY 45° BENT TUBE W/ O-RING & 12/30° UNIV. CONE

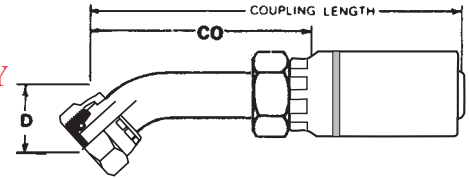

Part Number	Hose I.D.	Thread	DIN Tube O.D.(mm)	Nut Hex (mm)	-D-Drop	Fitting Length	-CO-Cutoff
204-1JDH-618 45	1/4	18MM X 1.5	10	22	.807	2.421	1.511
206-1JDH-620 45	3/8	20MM X 1.5	12	24	.984	2.815	1.905
206-1JDH-622 45	3/8	22MM X 1.5	14	27	.906	2.736	1.826
208-1JDH-624 45	1/2	24MM X 1.5	16	30	.945	3.150	1.990
210-1JDH-630 45	5/8	30MM X 2	20	36	1.240	3.622	2.462

METRIC SWIVEL FEMALE STEM DIN 20078 HEAVY STRAIGHT W/ O-RING & 12/30° UNIV. CONE

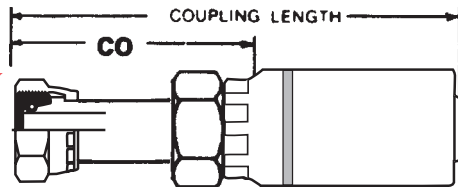

Part Number	Hose I.D.	Thread	DIN Tube O.D.(mm)	Nut Hex (mm)	Fitting Length	-CO-Cutoff
204-1JDH-616	1/4	16MM X 1.5	8	19	1.850	.940
204-1JDH-618	1/4	18MM X 1.5	10	22	1.890	.980
206-1JDH-618	3/8	18MM X 1.5	10	22	1.890	.980
206-1JDH-620	3/8	20MM X 1.5	12	24	2.106	1.196
206-1JDH-622	3/8	22MM X 1.5	14	27	1.969	1.059
208-1JDH-624	1/2	24MM X 1.5	16	30	2.165	1.005
210-1JDH-630	5/8	30MM X 2	20	36	2.520	1.360

METRIC SWIVEL FEMALE STEM DIN 20078 HEAVY 90° BENT TUBE W/ O-RING & 12/30° UNIV. CONE

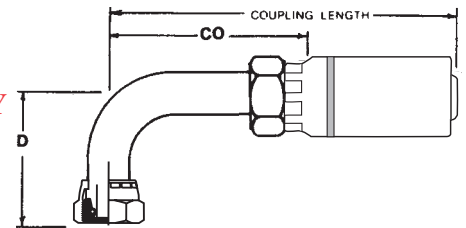

Part Number	Hose I.D.	Thread	DIN Tube O.D.(mm)	Nut Hex (mm)	-D-Drop	Fitting Length	-CO-Cutoff
204-1JDH-616 90	1/4	16MM X 1.5	8	19	1.378	1.929	1.019
204-1JDH-618 90	1/4	18MM X 1.5	10	22	1.437	1.929	1.019
206-1JDH-618 90	3/8	18MM X 1.5	10	22	1.594	2.244	1.334
206-1JDH-620 90	3/8	20MM X 1.5	12	24	1.811	2.244	1.334
206-1JDH-622 90	3/8	22MM X 1.5	14	27	1.693	2.244	1.334
208-1JDH-624 90	1/2	24MM X 1.5	16	30	1.831	2.717	1.557
210-1JDH-630 90	5/8	30MM X 2	20	36	2.461	3.071	1.911



1P One-Piece Compression Fittings for SAE 100R1AT, 100R2AT

NPTF SOLID MALE STEM

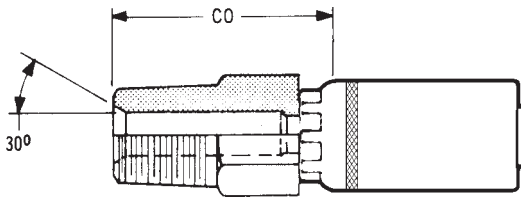

SAE 45° SOLID MALE STEM

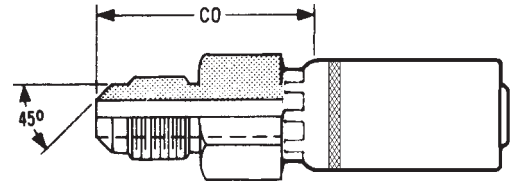

Part Number	Hose I.D.	Thread	Hex	Stem I.D.	Fitting Length	-CO-Cutoff
204-1P-102	1/4	1/8-27	5/8	.156	1.784	.874
204-1P-104	1/4	1/4-18	5/8	.156	1.940	1.030
204-1P-106	1/4	3/8-18	11/16	.156	1.940	1.030
204-1P-108	1/4	1/2-14	7/8	.156	2.175	1.265
206-1P-104	3/8	1/4-18	11/16	.296	1.971	1.061
206-1P-106	3/8	3/8-18	11/16	.296	1.971	1.061
206-1P-108	3/8	1/2-14	7/8	.296	2.222	1.312
208-1P-106	1/2	3/8-18	13/16	.406	2.472	1.312
208-1P-108	1/2	1/2-14	7/8	.406	2.472	1.312
208-1P-112	1/2	3/4-14	1-1/16	.406	2.534	1.374
212-1P-108	3/4	1/2-14	1-1/8	.562	2.614	1.364
212-1P-112	3/4	3/4-14	1-1/16	.625	2.676	1.526
212-1P-116	3/4	1 - 11-1/2	1-3/8	.625	2.926	1.676
216-1P-112	1	3/4-14	1-3/8	.717	2.922	1.452
216-1P-116	1	1 - 11-1/2	1-3/8	.843	3.172	1.702

Part Number	Hose I.D.	Thread	Hex	Stem I.D.	Fitting Length	-CO-Cutoff
204-1P-303	1/4	3/8-24	5/8	.156	1.815	.905
204-1P-304	1/4	7/16-20	5/8	.156	1.878	.968
204-1P-305	1/4	1/2-20	5/8	.156	1.939	1.029
206-1P-306	3/8	5/8-18	11/16	.296	2.002	1.092
206-1P-308	3/8	3/4-16	11/16	.296	2.159	1.249
208-1P-308	1/2	3/4-16	13/16	.406	2.472	1.312
208-1P-310	1/2	7/8-14	7/8	.406	2.602	1.442
212-1P-312	3/4	1-1/16 - 14	1-1/8	.625	2.926	1.676

NPTF SWIVEL MALE STEM

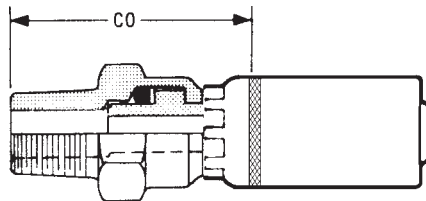

SAE 45° SWIVEL FEMALE STEM

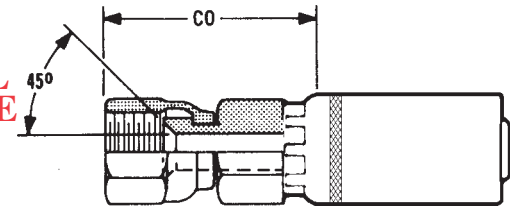

Leakage may occur at low pressure

Part Number	Hose I.D.	Thread	Nut Hex	Stem I.D.	Fitting Length	-CO-Cutoff
204-1P-202	1/4	1/8-27	1/2	.156	2.002	1.092
204-1P-204	1/4	1/4-18	11/16	.156	2.365	1.440
204-1P-206	1/4	3/8-18	13/16	.156	2.515	1.625
204-1P-208	1/4	1/2-14	7/8	.156	2.705	1.795
206-1P-204	3/8	1/4-18	11/16	.296	2.510	1.605
206-1P-206	3/8	3/8-18	13/16	.296	2.510	1.625
206-1P-208	3/8	1/2-14	7/8	.296	2.700	1.810
208-1P-206	1/2	3/8-18	1	.406	2.755	1.605
208-1P-208	1/2	1/2-14	1	.406	2.955	1.800
212-1P-208	3/4	1/2-14	1-5/16	.625	3.125	1.890
212-1P-212	3/4	3/4-14	1-5/16	.625	3.135	1.885
216-1P-216	1	1 - 11-1/2	1-5/8	.844	3.760	2.300

Part Number	Hose I.D.	Thread	Nut Hex	Stem Hex	Stem I.D.	Fitting Length	-CO-Cutoff
204-1P-404	1/4	7/16-20	5/8	9/16	.156	1.995	1.075
204-1P-405	1/4	1/2-20	5/8	11/16	.156	2.065	1.145
204-1P-406	1/4	5/8-18	5/8	3/4	.156	2.130	1.215
206-1P-404	3/8	7/16-20	11/16	9/16	.296	1.995	1.075
206-1P-406	3/8	5/8-18	11/16	3/4	.296	2.115	1.195
206-1P-408	3/8	3/4-16	11/16	7/8	.296	2.180	1.245
208-1P-406	1/2	5/8-18	13/16	3/4	.296	2.413	1.253
208-1P-408	1/2	3/4-16	13/16	7/8	.406	2.460	1.280
208-1P-410	1/2	7/8-14	13/16	1-1/16	.406	2.545	1.395
212-1P-410	3/4	7/8-14	1-1/16	1-1/16	.625	2.724	1.474
212-1P-412	3/4	1-1/16 - 14	1-1/16	1-1/4	.625	2.805	1.555

One-Piece Compression Fittings for SAE 100R1AT, 100R2AT

1P



JIC 37° SOLID MALE STEM

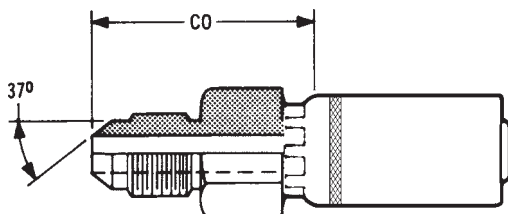

Part Number	Hose I.D.	Thread	Hex	Stem I.D.	Fitting Length	-CO-Cutoff
204-1P-504	1/4	7/16-20	5/8	.156	1.923	1.013
204-1P-505	1/4	1/2-20	5/8	.156	1.939	1.029
204-1P-506	1/4	9/16-18	5/8	.156	1.933	1.023
204-1P-507	1/4	5/8-18	5/8	.156	2.002	1.092
206-1P-506	3/8	9/16-18	11/16	.265	1.965	1.055
206-1P-508	3/8	3/4-16	3/4	.296	2.065	1.155
206-1P-510	3/8	7/8-14	7/8	.296	2.159	1.249
208-1P-508	1/2	3/4-16	13/16	.390	2.378	1.218
208-1P-510	1/2	7/8-14	7/8	.406	2.472	1.312
208-1P-512	1/2	1-1/16 - 12	1-1/16	.406	2.589	1.429
212-1P-510	3/4	7/8-14	1-1/16	.468	2.676	1.426
212-1P-512	3/4	1-1/16 - 12	1-1/8	.625	2.793	1.543
212-1P-514	3/4	1-3/16 - 12	1-1/4	.625	2.793	1.543
212-1P-516	3/4	1-5/16 - 12	1-3/8	.625	2.837	1.587
216-1P-516	1	1-5/16 - 12	1-5/8	.844	3.146	1.676
216-1P-520	1	1-5/8 - 12	1-5/8	.844	3.139	1.664

ORB SOLID MALE STEM

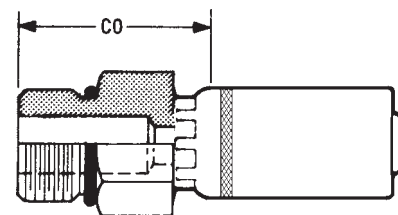

Part Number	Hose I.D.	Thread	Hex	Stem I.D.	Fitting Length	-CO-Cutoff
204-1P-704	1/4	7/16-20	5/8	.156	1.737	.827
204-1P-705	1/4	1/2-20	5/8	.156	1.737	.827
204-1P-706	1/4	9/16-18	11/16	.156	1.769	.859
206-1P-704	3/8	7/16-20	11/16	.250	1.769	.859
206-1P-705	3/8	1/2-20	11/16	.296	1.769	.859
206-1P-706	3/8	9/16-18	3/4	.296	1.862	.952
206-1P-708	3/8	3/4-16	7/8	.296	1.937	1.027
208-1P-710	3/8	7/8-14	1	.296	1.972	1.062
206-1P-712	3/8	1-1/16-12	1-1/4	.296	2.128	1.218
208-1P-708	1/2	3/4-16	7/8	.406	2.160	1.000
208-1P-710	1/2	7/8-14	1	.406	2.222	1.062
208-1P-712	1/2	1-1/16 - 12	1-1/4	.406	2.348	1.188
212-1P-710	3/4	7/8-14	1-1/16	.625	2.333	1.083
212-1P-712	3/4	1-1/16 - 12	1-1/4	.625	2.520	1.270
212-1P-714	3/4	1-3/16 - 12	1-3/8	.625	2.520	1.270
212-1P-716	3/4	1-5/16 - 12	1-1/2	.625	2.520	1.270
216-1P-712	1	1-1/16 - 12	1-3/8	.844	2.829	1.359
216-1P-714	1	1-3/16 - 12	1-3/8	.844	2.829	1.359
216-1P-716	1	1-5/16 - 12	1-1/2	.844	2.829	1.359

JIC 37° SWIVEL FEMALE STEM

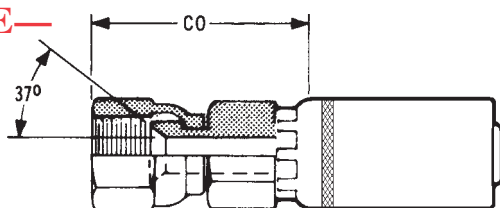

Part Number	Hose I.D.	Thread	Stem Hex	Nut Hex	Stem I.D.	Fitting Length	-CO-Cutoff
204-1P-604	1/4	7/16-20	5/8	9/16	.156	1.995	1.070
204-1P-605	1/4	1/2-20	5/8	11/16	.156	2.050	1.125
204-1P-606	1/4	9/16-18	5/8	3/4	.156	2.035	1.120
206-1P-604	3/8	7/16-20	3/8	7/8	.296	2.030	1.105
206-1P-606	3/8	9/16-18	11/16	3/4	.296	2.030	1.105
206-1P-608	3/8	3/4-16	11/16	7/8	.296	2.165	1.245
206-1P-610	3/8	7/8-14	13/16	1-1/16	.296	2.245	1.345
208-1P-606	1/2	9/16-18	13/16	3/4	.296	2.340	1.165
208-1P-608	1/2	3/4-16	13/16	7/8	.406	2.470	1.310
208-1P-610	1/2	7/8-14	13/16	1-1/16	.406	2.530	1.370
208-1P-612	1/2	1-1/16 - 12	1	1-1/4	.406	2.655	1.505
212-1P-610	3/4	7/8-14	1-1/16	1-1/16	.500	2.745	1.490
212-1P-612	3/4	1-1/16 - 12	1-1/16	1-1/4	.625	2.810	1.570
212-1P-614	3/4	1-3/16 - 12	1-1/8	1-3/8	.625	2.830	1.585
212-1P-616	3/4	1-5/16 - 12	1-1/4	1-1/2	.625	2.920	1.700
216-1P-612	1	1-1/16 - 12	1-3/8	1-1/4	.718	3.040	1.580
216-1P-614	1	1-3/16 - 12	1-3/8	1-3/8	.844	3.055	1.600
216-1P-616	1	1-5/16 - 12	1-3/8	1-1/2	.844	3.175	1.720
216-1P-620	1	1-5/8 - 12	1-1/2	2	.844	3.175	1.825

ORB SWIVEL MALE STEM

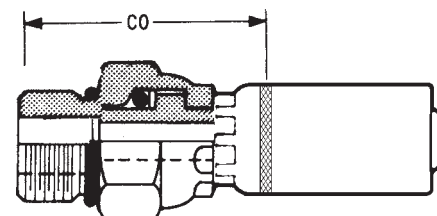

Leakage may occur at low pressure

Part Number	Hose I.D.	Thread	Nut Hex	Stem I.D.	Fitting Length	-CO-Cutoff
204-1P-805	1/4	1/2-20	11/16	.156	2.260	1.340
204-1P-806	1/4	9/16-18	11/16	.156	2.270	1.365
206-1P-806	3/8	9/16-18	11/16	.296	2.320	1.405
206-1P-808	3/8	3/4-16	7/8	.296	2.275	1.365
206-1P-810	3/8	7/8-14	1	.296	2.485	1.570
208-1P-808	1/2	3/4-16	1	.406	2.650	1.500
208-1P-810	1/2	7/8-14	1	.406	2.695	1.535
212-1P-812	3/4	1-1/16 - 12	1-5/16	.625	3.125	1.890
212-1P-814	3/4	1-3/16 - 12	1-5/16	.625	2.960	1.720



1P One-Piece Compression Fittings for SAE 100R1AT, 100R2AT

NPTF SOLID FEMALE STEM

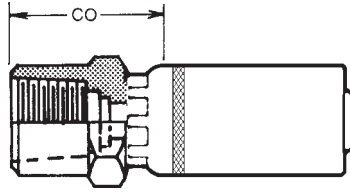

Part Number	Hose I.D.	Thread	Nut Hex	Stem I.D.	Fitting Length	-CO-Cutoff
204-1P-902	1/4	1/8-27	5/8	.156	1.784	.874
204-1P-904	1/4	1/4-18	11/16	.156	1.784	.874
204-1P-906	1/4	3/8-18	13/16	.156	1.972	1.782
206-1P-904	3/8	1/4-18	11/16	.296	1.784	.874
206-1P-906	3/8	3/8-18	13/16	.296	1.847	.937
206-1P-908	3/8	1/2-14	1	.296	2.050	1.140
208-1P-906	1/2	3/8-18	13/16	.406	2.050	1.140
208-1P-908	1/2	1/2-14	1	.406	2.300	1.140
212-1P-912	3/4	3/4-14	1-1/4	.625	2.676	1.426
216-1P-916	1	1 - 11-1/2	1-1/2	.844	3.031	1.561

MALE "O"-LOK STEM

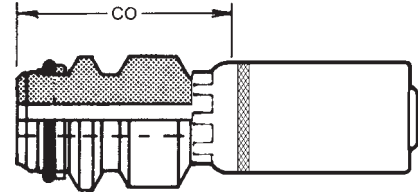

Part Number	Hose I.D.	Male Size	Stem I.D.	Fitting Length	-CO-Cutoff
204-1P-S04	1/4	1/4	.156	2.227	1.317
206-1P-S06	3/8	3/8	.296	2.227	1.317
208-1P-S08	1/2	1/2	.406	2.477	1.287
412-1P-S12	3/4	3/4	.625	2.619	1.369
416-1P-S16	1	1	.843	3.370	1.600

SOLID FEMALE GREASE FITTING STEM

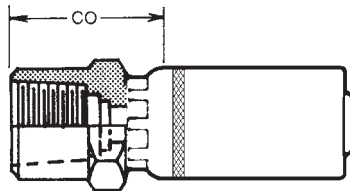

Part Number	Hose I.D.	Thread	Nut Hex	Stem I.D.	Fitting Length	-CO-Cutoff
204-1PSP-908	1/4	1/2-27	1-1/16	.156	1.784	.874
206-1PSP-908	3/8	1/2-27	1-1/16	.296	1.784	.874

NPSM SWIVEL FEMALE STEM

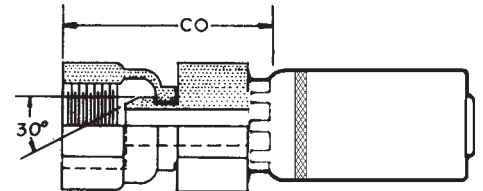

Part Number	Hose I.D.	Thread	Stem Hex	Nut Hex	Stem I.D.	Fitting Length	-CO-Cutoff
204-1P-4 FPX	1/4	1/4-18	5/8	11/16	.156	1.937	1.027
204-1P-6 FPX	1/4	3/8-18	5/8	7/8	.156	2.040	1.143
206-1P-4 FPX	3/8	1/4-18	11/16	11/16	.250	1.960	1.079
206-1P-6 FPX	3/8	3/8-18	11/16	7/8	.296	2.062	1.153
208-1P-8 FPX	1/2	1/2-14	13/16	1	.406	2.390	1.230
212-1P-12 FPX	3/4	3/4-14	1-1/16	1-1/4	.625	2.769	1.519
216-1P-16 FPX	1	1 - 11-1/2	1-3/8	1-1/2	.843	2.980	1.520

45° SOLID FEMALE INVERTED FLARE STEM

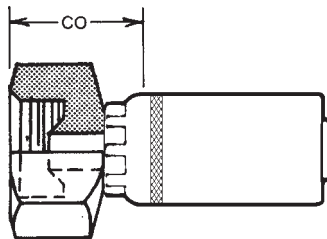

Part Number	Hose I.D.	Thread	Hex	Stem I.D.	Fitting Length	-CO-Cutoff
204-1P-904 IF	1/4	7/16-24	11/16	.156	1.597	.687
204-1P-905 IF	1/4	1/2-20	11/16	.156	1.597	.687
204-1P-906 IF	1/4	5/8-18	3/4	.156	1.597	.687
206-1P-906 IF	3/8	5/8-18	3/4	.296	1.532	.622

One-Piece Compression Fittings for SAE 100R1AT, 100R2AT

1P



MALE FLARELESS STEM

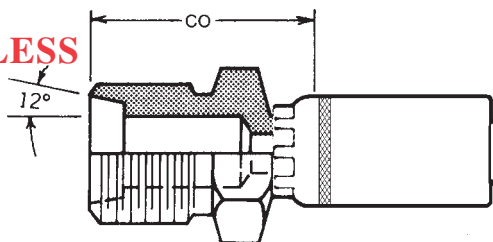

Part Number	Hose I.D.	Thread	Hex	Stem I.D.	Fitting Length	-CO-Cutoff
204-1P-E04	1/4	7/16-20	5/8	.156	1.831	.921
204-1P-E06	1/4	9/16-18	5/8	.156	1.847	.937
206-1P-E05	3/8	1/2-20	11/16	.234	1.863	.953
206-1P-E06	3/8	9/16-18	11/16	.296	1.879	.969
206-1P-E08	3/8	3/4-16	13/16	.296	1.971	1.061
208-1P-E08	1/2	3/4-16	13/16	.406	2.285	1.125
208-1P-E10	1/2	7/8-14	1	.406	2.348	1.188

JIC 37° SWIVEL FEMALE STEM 45° BENT TUBE SHORT DROP

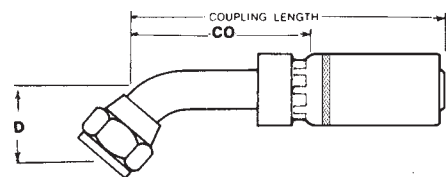

Part Number	Hose I.D.	Thread	Hex	-D-Drop	Fitting Length	-CO-Cutoff
204-1PS-684	1/4	7/16-20	9/16	.330	2.570	1.695
204-1PS-685	1/4	1/2-20	5/8	.360	2.670	1.795
204-1PS-686	1/4	9/16-18	11/16	.410	2.890	2.010
206-1PS-686	3/8	9/16-18	11/16	.410	2.890	2.015
206-1PS-688	3/8	3/4-16	7/8	.550	3.240	2.240
208-1PS-688	1/2	3/4-16	7/8	.550	3.240	2.303
208-1PS-690	1/2	7/8-14	1	.650	3.540	2.603
212-1PS-692	3/4	1-1/16 - 12	1-1/4	.780	4.020	2.895
212-1PS-694	3/4	1-3/16 - 12	1-3/8	.860	4.280	3.150
212-1PS-696	3/4	1-5/16 - 12	1-1/2	.890	4.430	3.300
216-1PS-692	1	1-1/16 - 12	1-1/4	.780	4.430	2.960
216-1PS-696	1	1-5/16 - 12	1-1/2	.890	4.430	2.960

SAE 45° SWIVEL FEMALE ONE-PIECE 45° BENT TUBE SHORT DROP

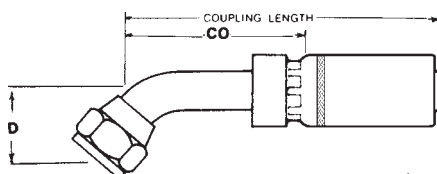

Part Number	Hose I.D.	Thread	Nut Hex	-D-Drop	Fitting Length	-CO-Cutoff
208-1PS-468	1/2	3/4-16	7/8	1.090	2.557	1.620

JIC 37° SWIVEL FEMALE STEM 45° BENT TUBE MEDIUM DROP

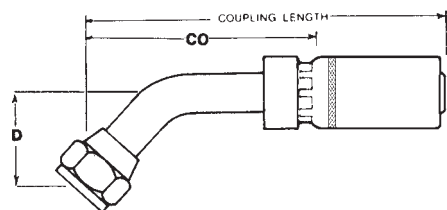

Part Number	Hose I.D.	Thread	Hex	-D-Drop	Fitting Length	-CO-Cutoff
204-1PM-684	1/4	7/16-20	9/16	.470	2.570	1.690
204-1PM-685	1/4	1/2-20	5/8	.590	2.670	1.790
204-1PM-686	1/4	9/16-18	11/16	.590	2.890	2.010
206-1PM-686	3/8	9/16-18	11/16	.590	2.890	2.015
206-1PM-688	3/8	3/4-16	7/8	.690	3.240	2.200
208-1PM-688	1/2	3/4-16	7/8	.690	3.240	2.303
208-1PM-690	1/2	7/8-14	1	.780	3.540	2.600
212-1PM-690	3/4	7/8-14	1	.780	3.770	2.640
212-1PM-692	3/4	1-1/16 - 12	1-1/4	1.060	4.020	2.895
212-1PM-696	3/4	1-5/16 - 12	1-1/2	1.160	4.440	3.310
216-1PM-696	1	1-5/16 - 12	1-1/2	1.160	4.780	3.315

SAE 45° SWIVEL FEMALE ONE-PIECE 90° BENT TUBE MEDIUM DROP

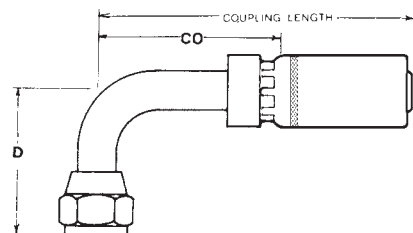

Part Number	Hose I.D.	Thread	Nut Hex	-D-Drop	Fitting Length	-CO-Cutoff
204-1PM-464	1/4	7/16-20	9/16	.880	2.300	1.425
206-1PM-466	3/8	5/8-18	3/4	1.160	2.640	1.765

JIC 37° SWIVEL FEMALE STEM 45° BENT TUBE LONG DROP

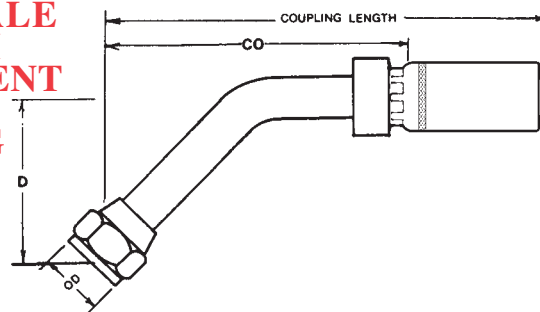

Part Number	Hose I.D.	Thread	Nut Hex	-D-Drop	Fitting Length	-CO-Cutoff
208-1PL-688	1/2	3/4-16	7/8	.700	3.400	2.500
208-1PL-690	1/2	7/8-14	1	.880	3.640	2.700
216-1PL-696	1	1-5/16 - 12	1-1/2	1.330	4.960	3.490



1P One-Piece Compression Fittings for SAE 100R1AT, 100R2AT

JIC 37° SWIVEL FEMALE STEM 90° BENT TUBE SHORT DROP

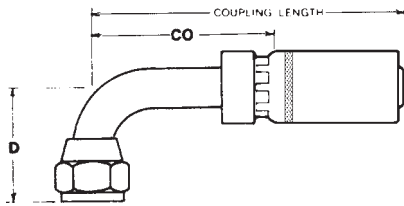

Part Number	Hose I.D.	Thread	Nut Hex	-D-Drop	Fitting Length	-CO-Cutoff
204-1PS-664	1/4	7/16-20	9/16	.780	2.300	1.425
204-1PS-665	1/4	1/2-20	5/8	.900	2.390	1.510
204-1PS-666	1/4	9/16-18	11/16	.920	2.540	1.665
206-1PS-666	3/8	9/16-18	11/16	.920	2.540	1.670
206-1PS-668	3/8	3/4-16	7/8	1.170	2.635	1.755
208-1PS-668	1/2	3/4-16	7/8	1.170	2.697	1.760
208-1PS-670	1/2	7/8-14	1	1.320	3.060	2.123
212-1PS-670	3/4	7/8-14	1	1.320	3.290	2.160
212-1PS-672	3/4	1-1/16 - 12	1-1/4	1.870	3.880	2.755
212-1PS-674	3/4	1-3/16 - 12	1-3/8	2.000	4.250	3.120
212-1PS-676	3/4	1-5/16 - 12	1-1/2	2.240	4.375	3.250
216-1PS-676	1	1-5/16 - 12	1-1/2	2.240	4.720	3.250

JIC 37° SWIVEL FEMALE STEM 90° BENT TUBE LONG DROP

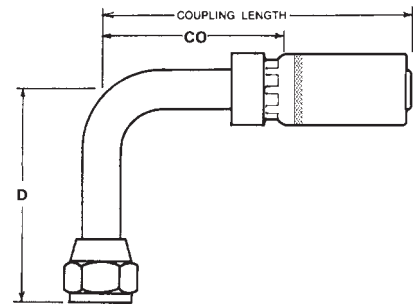

Part Number	Hose I.D.	Thread	Nut Hex	-D-Drop	Fitting Length	-CO-Cutoff
204-1PL-664	1/4	7/16-20	9/16	1.800	2.300	1.425
204-1PL-665	1/4	1/2-20	5/8	1.800	2.390	1.515
204-1PL-666	1/4	9/16-18	11/16	2.180	2.550	1.675
206-1PL-666	3/8	9/16-18	11/16	2.180	2.540	1.665
206-1PL-668	3/8	3/4-16	7/8	2.430	2.760	1.880
208-1PL-668	1/2	3/4-16	7/8	2.430	2.760	1.823
208-1PL-670	1/2	7/8-14	1	2.570	3.060	2.123
208-1PL-672	1/2	1-1/16-12	1-1/4	3.730	3.670	2.730
212-1PL-672	3/4	1-1/16 - 12	1-1/4	3.730	3.880	2.755
212-1PL-674	3/4	1-3/16 - 12	1-3/8	3.930	4.010	2.885
212-1PL-676	3/4	1-5/16 - 12	1-1/2	4.330	4.370	3.240
216-1PL-674	1	1-3/16 - 12	1-3/8	3.930	4.370	2.890
216-1PL-676	1	1-5/16 - 12	1-1/2	4.330	4.720	3.250

JIC 37° SWIVEL FEMALE STEM 90° BENT TUBE MEDIUM DROP

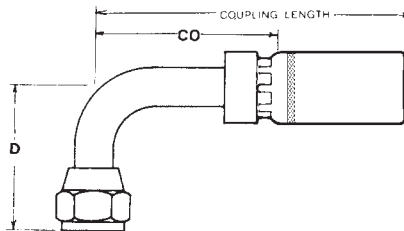

JIC 37° SWIVEL FEMALE STEM 30° BENT TUBE SHORT DROP

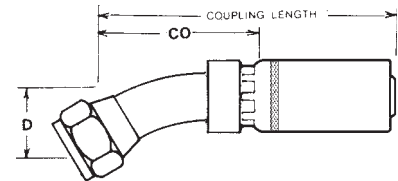

Part Number	Hose I.D.	Thread	Nut Hex	-D-Drop	Fitting Length	-CO-Cutoff
210-1PS-622	5/8	1-1/16 - 12	1-1/4	.480	3.620	2.49

Part Number	Hose I.D.	Thread	Nut Hex	-D-Drop	Fitting Length	-CO-Cutoff
204-1PM-664	1/4	7/16-20	9/16	.880	2.300	1.425
204-1PM-665	1/4	1/2-20	5/8	1.130	2.390	1.515
204-1PM-666	1/4	9/16-18	11/16	1.130	2.540	1.670
206-1PM-666	3/8	9/16-18	11/16	1.130	2.540	1.670
206-1PM-668	3/8	3/4-16	7/8	1.380	2.760	1.885
208-1PM-668	1/2	3/4-16	7/8	1.380	2.760	1.823
208-1PM-670	1/2	7/8-14	1	1.750	3.060	2.123
212-1PM-670	3/4	7/8-14	1	1.750	3.290	2.160
212-1PM-672	3/4	1-1/16 - 12	1-1/4	2.060	3.880	2.755
212-1PM-676	3/4	1-5/16 - 12	1-3/8	2.620	4.370	3.240
216-1PM-676	1	1-5/16 - 12	1-3/8	2.620	4.720	3.250
216-1PM-678	1	1-5/8 - 12	1-1/2	3.400	5.850	4.400

SAE 45° MALE INVERTED SWIVEL STEM STRAIGHT TUBE

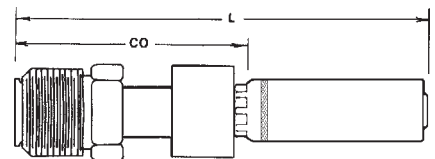

Part Number	Hose I.D.	Thread	Nut Hex	Fitting Length	-CO-Cutoff
204-1P-B03	1/4	3/8-24	3/8	2.380	1.505
204-1P-B04	1/4	7/16-24	7/16	2.440	1.565
204-1P-B05	1/4	1/2-20	1/2	2.560	1.685
206-1P-B04	3/8	7/16-24	7/16	2.440	1.565
206-1P-B05	3/8	1/2-20	1/2	2.560	1.685
206-1P-B06	3/8	5/8-18	5/8	2.600	1.725
206-1P-B07	3/8	11/16-18	11/16	2.680	1.805
206-1P-B08	3/8	3/4-18	3/4	2.800	1.925
208-1P-B06	1/2	5/8-18	5/8	2.660	1.723
208-1P-B08	1/2	3/4-18	3/4	2.860	1.923
208-1P-B10	1/2	7/8-18	7/8	2.920	1.983

One-Piece Compression Fittings for SAE 100R1AT, 100R2AT

1P



SAE 45° MALE INVERTED SWIVEL STEM 45° BENT TUBE

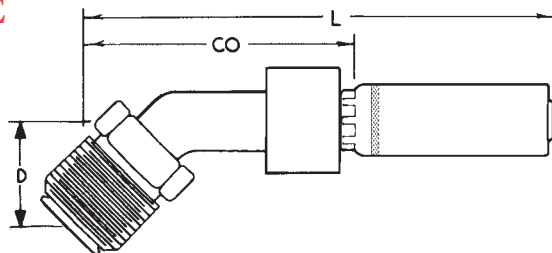

Part Number	Hose I.D.	Thread	Nut Hex	-D-Drop	Fitting Length	-CO-Cutoff
204-1P-B43	1/4	3/8-24	3/8	.530	2.490	1.615
204-1P-B44	1/4	7/16-24	7/16	.570	2.660	1.780
204-1P-B45	1/4	1/2-20	1/2	.650	2.850	1.975
206-1P-B44	3/8	7/16-24	7/16	.570	2.660	1.780
206-1P-B45	3/8	1/2-20	1/2	.650	2.850	1.975
206-1P-B46	3/8	5/8-18	5/8	.710	3.000	2.125
206-1P-B47	3/8	11/16-18	11/16	.760	3.126	2.240
206-1P-B48	3/8	3/4-18	3/4	.850	3.330	2.450
208-1P-B48	1/2	3/4-18	3/4	.850	3.390	2.515
208-1P-B50	1/2	7/8-18	7/8	.960	3.600	2.660

SOLID MALE FLAT FACE "O" RING SEAL STEM

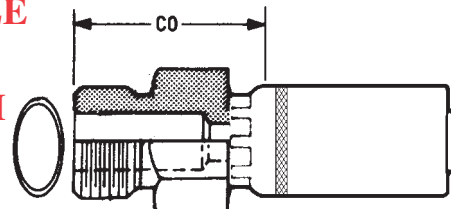

Part Number	Hose I.D.	Thread	Hex	Stem I.D.	Fitting Length	-CO-Cutoff	"O" Ring Part No.
204-1PFS-04	1/4	9/16-18	5/8	.156	1.764	.850	4 ORFS
204-1PFS-06	1/4	11/16-16	3/4	.156	1.850	.940	6 ORFS
206-1PFS-04	3/8	6/16-18	3/4	.265	1.858	.948	4 ORFS
206-1PFS-06	3/8	11/16-16	3/4	.265	1.850	.940	6 ORFS
206-1PFS-08	3/8	13/16-16	7/8	.265	1.976	1.066	8 ORFS
208-1PFS-06	1/2	11/16-16	7/8	.375	2.163	1.003	6 ORFS
208-1PFS-08	1/2	13/16-16	7/8	.375	2.226	1.065	8 ORFS
208-1PFS-10	1/2	1-14	1	.406	2.363	1.203	10 ORFS
412-1PFS-10	3/4	1-14	1-1/4	.609	3.141	1.286	10 ORFS
412-1PFS-12	3/4	1-3/16 - 12	1-1/4	.609	3.201	1.345	12 ORFS
416-1PFS-16	1	1-7/16 - 12	1-1/2	.812	3.504	1.455	16 ORFS

SAE 45° MALE INVERTED SWIVEL STEM 90° BENT TUBE

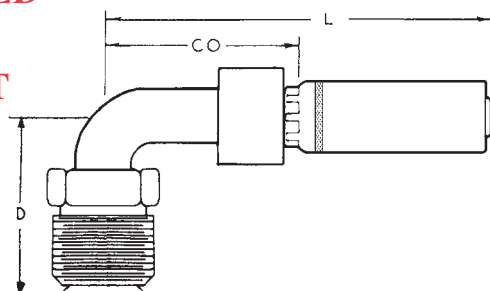

Part Number	Hose I.D.	Thread	Nut Hex	-D-Drop	Fitting Length	-CO-Cutoff
204-1P-B63	1/4	3/8-24	3/8	.970	2.180	1.300
204-1P-B64	1/4	7/16-24	7/16	1.100	2.380	1.505
204-1P-B65	1/4	1/2-20	1/2	1.280	2.560	1.680
206-1P-B64	3/8	7/16-24	7/16	1.100	2.380	1.500
206-1P-B65	3/8	1/2-20	1/2	1.280	2.560	1.680
206-1P-B66	3/8	5/8-18	5/8	1.450	2.730	1.855
206-1P-B67	3/8	11/16-18	11/16	1.600	2.880	2.005
206-1P-B68	3/8	3/4-18	3/4	1.780	3.060	2.180
208-1P-B68	1/2	3/4-18	3/4	1.780	3.120	2.185
208-1P-B70	1/2	7/8-18	7/8	2.090	3.370	2.430

SWIVEL FEMALE FLAT FACE "O" RING SEAL STEM STRAIGHT

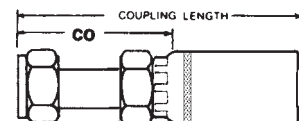

Part Number	Hose I.D.	Thread	Nut Hex	Stem Hex	Fitting Length	-CO-Cutoff
204-1PFSX-04	1/4	9/16-18	5/8	11/16	1.702	.792
204-1PFSX-06	1/4	11/16-16	5/8	13/16	1.727	.817
206-1PFSX-06	3/8	11/16-16	11/16	13/16	1.727	.817
206-1PFSX-08	3/8	13/16-16	3/4	15/16	1.764	.854
208-1PFSX-06	1/2	11/16-16	7/8	13/16	1.977	.817
208-1PFSX-08	1/2	13/16-16	13/16	15/16	2.062	.902
208-1PFSX-10	1/2	1 - 14	7/8	1-1/8	2.079	.919
208-1PFSX-12	1/2	1-3/16 - 12	1-1/8	1-3/8	2.092	.932
412-1PFSX-08	3/4	13/16-16	1-1/16	15/16	2.856	1.001
412-1PFSX-10	3/4	1 - 14	1-1/16	1-1/8	2.874	1.019
412-1PFSX-12	3/4	1-3/16 - 12	1-1/16	1-3/8	2.887	1.032
412-1PFSX-16	3/4	1-7/16 - 12	1-3/8	1-5/8	3.022	1.167
416-1PFSX-16	1	1-7/16 - 12	1-3/8	1-5/8	3.243	1.193



1P One-Piece Compression Fittings for SAE 100R1AT, 100R2AT

SWIVEL FEMALE FLAT FACE "O" RING SEAL STEM 45°

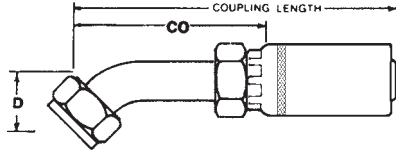

Part Number	Hose I.D.	Thread	Nut Hex	-D-Drop	Fitting Length	-CO-Cutoff
204-1PFSX-L64	1/4	9/16-18	11/16	.410	2.450	1.575
206-1PFSX-L66	3/8	11/16-16	13/16	.430	2.750	1.840
206-1PFSX-L68	3/8	13/16-16	15/16	.590	3.100	2.190
208-1PFSX-L68	1/2	13/16-16	15/16	.590	3.350	2.190
412-1PFSX-L72	3/4	1-3/16-12	1-3/8	.830	4.525	2.670
416-1PFSX-L76	1	1-7/16 - 12	1-5/8	.940	5.625	3.575

SWIVEL FEMALE FLAT FACE "O" RING SEAL STEM 90° MEDIUM DROP

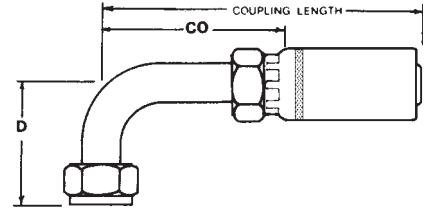

Part Number	Hose I.D.	Thread	Nut Hex	-D-Drop	Fitting Length	-CO-Cutoff
204-1PFSX-J34	1/4	9/16-18	11/16	1.260	2.450	1.550
204-1PFSX-J36	1/4	11/16-16	13/16	1.500	2.850	1.985
206-1PFSX-J36	3/8	11/16-16	13/16	1.500	2.850	1.940
208-1PFSX-J38	1/2	13/16-16	15/16	1.620	3.425	2.300
208-1PFSX-J40	1/2	1 - 14	1-1/8	1.850	3.240	2.319
412-1PFSX-J42	3/4	1-3/16 - 12	1-3/8	2.280	4.575	2.720
416-1PFSX-J46	1	1-7/16 - 12	1-5/8	2.780	5.625	3.550

SWIVEL FEMALE FLAT FACE "O" RING SEAL STEM 90° SHORT DROP

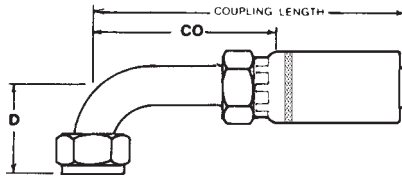

Part Number	Hose I.D.	Thread	Nut Hex	-D-Drop	Fitting Length	-CO-Cutoff
204-1PFSX-A24	1/4	9/16-18	11/16	.820	2.425	1.550
206-1PFSX-A26	3/8	11/16-16	13/16	.900	2.750	1.840
206-1PFSX-A28	3/8	13/16-16	15/16	1.150	3.170	2.230
208-1PFSX-A28	1/2	13/16-16	15/16	1.150	2.260	2.215
208-1PFSX-A30	1/2	1 - 14	1-1/8	1.490	3.010	1.850
412-1PFSX-A32	3/4	1-3/16 - 12	1-3/8	1.880	4.705	2.850
416-1PFSX-A36	1	1-7/16 - 12	1-5/8	2.200	5.875	3.825

SWIVEL FEMALE FLAT FACE "O" RING SEAL STEM 90° LONG DROP

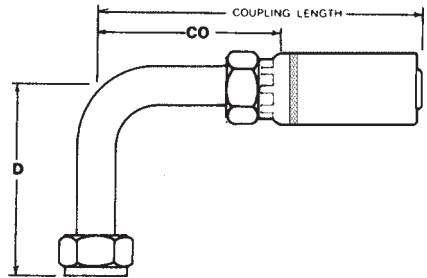

Part Number	Hose I.D.	Thread	Nut Hex	-D-Drop	Fitting Length	-CO-Cutoff
204-1PFSX-A64	1/4	9/16-18	11/16	1.800	2.450	1.575
206-1PFSX-A66	3/8	11/16-16	13/16	2.130	2.875	1.965
208-1PFSX-A68	1/2	13/16-16	15/16	2.500	3.450	2.300
412-1PFSX-A72	3/4	1-3/16 - 12	1-3/8	3.780	4.550	2.750
416-1PFSX-A76	1	1-7/16 - 12	1-5/8	4.500	5.590	3.540

One-Piece British Standard and Metric Fittings for SAE 100R1AT and 100R2AT

1P



BRITISH STANDARD PARALLEL PIPE BSPP SOLID MALE STEM 30° SEAT

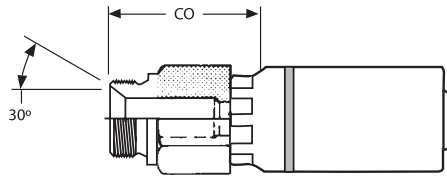

Part Number	Hose I.D.	Thread	Hex	Fitting Length	-CO-Cutoff
204-1PBP-104	1/4	1/4-19	3/4	1.891	.981
206-1PBP-106	3/8	3/8-19	7/8	1.981	1.071
208-1PBP-108	1/2	1/2-14	1-1/16	2.392	1.232
412-1PBP-112	3/4	3/4-14	1-1/4	3.281	1.426
416-1PBP-116	1	1-11	1-5/8	3.645	1.595

BSPP SWIVEL FEMALE STEM 30° CONE 45° BENT TUBE

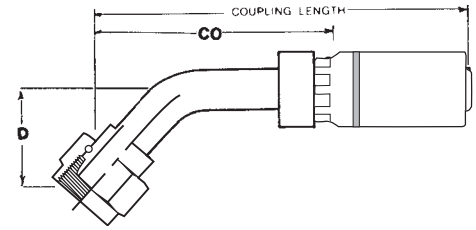

Part Number	Hose I.D.	Thread	Nut Hex	-D-Drop	Fitting Length	-CO-Cutoff
204-1PBPX-4 45	1/4	1/4-19	11/16	.500	2.565	1.690
204-1PBPX-6 45	1/4	3/8-19	7/8	.625	2.885	2.010
206-1PBPX-6 45	3/8	3/8-19	7/8	.625	2.885	2.010
208-1PBPX-8 45	1/2	1/2-14	1	.750	3.137	2.200
412-1PBPX-12 45	3/4	3/4-14	1-1/4	1.125	4.755	2.900
416-1PBPX-16 45	1	1-11	1-1/2	1.250	5.360	3.310

JIS SWIVEL FEMALE STEM 30° SEAT

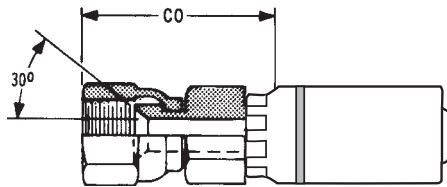

Part Number	Hose I.D.	Thread	Nut Hex	Stem Hex	Fitting Length	-CO-Cutoff
204-1PBP-604	1/4	1/4-19	11/16	5/8	1.937	1.027
206-1PBP-606	3/8	3/8-19	7/8	11/16	2.033	1.123
208-1PBP-608	1/2	1/2-14	1	13/16	2.378	1.218
412-1PBP-612	3/4	3/4-14	1-1/4	1-1/16	3.344	1.489
416-1PBP-616	1	1-11	1-1/2	1-3/8	3.565	1.515
220-1PBP-620	1-1/4	1-1/4-11	1-7/8	1-3/4	4.036	2.114

BSPP SWIVEL FEMALE STEM 30° CONE 90° BENT TUBE

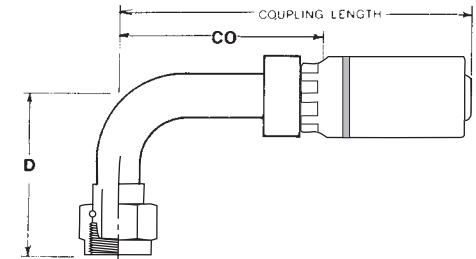

Part Number	Hose I.D.	Thread	Nut Hex	-D-Drop	Fitting Length	-CO-Cutoff
204-1PBPX-4 90	1/4	1/4-19	11/16	1.625	2.390	1.515
206-1PBPX-6 90	3/8	3/8-19	7/8	1.625	2.540	1.665
208-1PBPX-8 90	1/2	1/2-14	1	1.750	2.817	1.880
208-1PBPX-10 90	1/2	5/8-14	1-1/16	2.000	3.057	2.120
412-1PBPX-12 90	3/4	3/4-14	1-1/4	2.250	4.610	2.755
416-1PBPX-16 90	1	1-11	1-1/2	2.250	4.940	2.890
220-1PBPX-20 90	1-1/4	1-1/4-11	1-7/8	4.500	6.843	4.920

BRITISH STANDARD PARALLEL PIPE BSPP SWIVEL FEMALE STEM 30° CONE

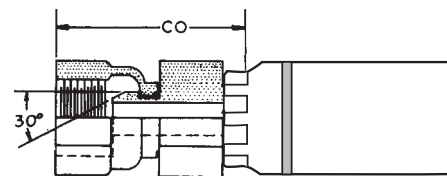

Part Number	Hose I.D.	Thread	Nut Hex	Stem Hex	Fitting Length	-CO-Cutoff
204-1PBPX-4	1/4	1/4-19	11/16	5/8	1.939	1.029
204-1PBPX-6	1/4	3/8-19	7/8	5/8	2.033	1.123
206-1PBPX-6	3/8	3/8-19	7/8	11/16	2.033	1.123
206-1PBPX-8	3/8	1/2-14	1	13/16	2.127	1.217
208-1PBPX-8	1/2	1/2-14	1	13/16	2.377	1.217
208-1PBPX-10	1/2	5/8-14	1-1/16	13/16	2.464	1.304
412-1PBPX-12	3/4	3/4-14	1-1/4	1-1/16	3.344	1.489
416-1PBPX-16	1	1-11	1-1/2	1-3/8	3.565	1.515
220-1PBPX-20	1-1/4	1-1/4-11	1-7/8	1-3/4	4.036	2.114

BRITISH STANDARD TAPERED PIPE BSPT SOLID MALE STEM 30° SEAT

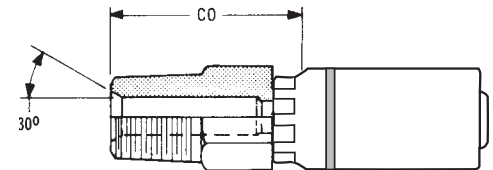

Part Number	Hose I.D.	Thread	Hex	Fitting Length	-CO-Cutoff
204-1PBT-104	1/4	1/4-19	5/8	1.875	.965
204-1PBT-106	1/4	3/8-19	11/16	1.875	.965
206-1PBT-106	3/8	3/8-19	11/16	1.906	.996
208-1PBT-108	1/2	1/2-14	7/8	2.316	1.156
412-1PBT-112	3/4	3/4-14	1-1/16	3.197	1.342
416-1PBT-116	1	1-11	1-3/8	3.603	1.553



1P

One-Piece British Standard and Metric Fittings for SAE 100R1AT and 100R2AT

KOMATSU SWIVEL FEMALE STEM 30° SEAT

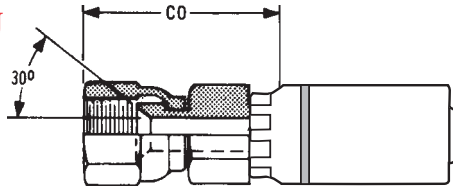

Part Number	Hose I.D.	Thread	Nut Hex	Stem Hex	Fitting Length	-CO-Cutoff
204-1PKU-614	1/4	14MM X 1.5	3/4	5/8	2.035	1.125
204-1PKU-618	1/4	18MM X 1.5	7/8	11/16	2.158	1.248
206-1PKU-618	3/8	18MM X 1.5	7/8	11/16	2.158	1.248
208-1PKU-622	1/2	22MM X 1.5	1-1/16	13/16	2.545	1.385
208-1PKU-624	1/2	24MM X 1.5	1-1/4	1	2.631	1.471
412-1PKU-630	3/4	30MM X 1.5	1-1/2	1-1/4	3.584	1.729
416-1PKU-633	1	33MM X 1.5	1-5/8	1-3/8	3.805	1.755
220-1PKU-636	1-1/4	36MM X 1.5	1-3/4	1-3/4	4.198	2.276
224-1PKU-642	1-1/2	42MM X 1.5	2-1/4	2	4.795	2.457

METRIC SWIVEL FEMALE STEM DIN 20078 LIGHT 45° BENT TUBE W/ O-RING

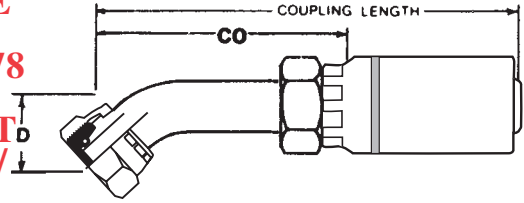

Part Number	Hose I.D.	Thread	DIN Tube O.D.(mm)	Nut Hex (mm)	-D-Drop	Fitting Length	-CO-Cutoff
206-1PDL-616	45 3/8	16MM X 1.5	10	19	.827	2.638	1.728
206-1PDL-618	45 3/8	18MM X 1.5	12	22	.846	2.677	1.767
208-1PDL-622	45 1/2	22MM X 1.5	15	27	.984	3.189	2.029

SOLID MALE STEM DIN 20078 LIGHT 12° SEAT

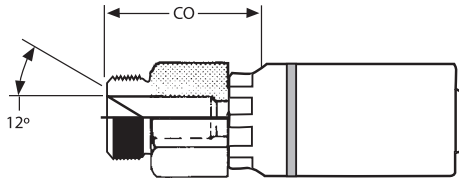

Part Number	Hose I.D.	Thread	Hex	Fitting Length	-CO-Cutoff
204-1PDL-112	1/4	12MM X 1.5	1/2	1.793	.883
204-1PDL-114	1/4	14MM X 1.5	5/8	1.793	.883
206-1PDL-116	3/8	16MM X 1.5	11/16	1.824	.914
206-1PDL-118	3/8	18MM X 1.5	3/4	1.824	.914
208-1PDL-122	1/2	22MM X 1.5	7/8	2.222	1.062
412-1PDL-126	3/4	26MM X 1.5	1-1/16	3.031	1.176
412-1PDL-130	3/4	30MM X 2	1-1/4	3.081	1.226

METRIC SWIVEL FEMALE STEM DIN 20078 LIGHT 90° BENT TUBE W/ O-RING

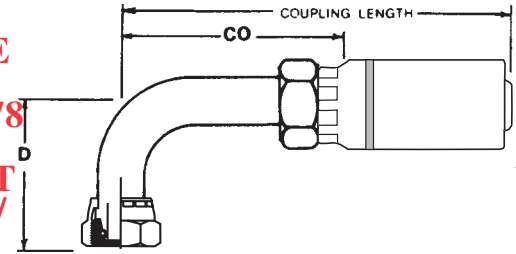

Part Number	Hose I.D.	Thread	DIN Tube O.D.(mm)	Nut Hex (mm)	-D-Drop	Fitting Length	-CO-Cutoff
204-1PDL-614	90 1/4	14MM X 1.5	8	17	1.378	1.929	1.019
206-1PDL-616	90 3/8	16MM X 1.5	10	19	1.575	2.244	1.334
206-1PDL-618	90 3/8	18MM X 1.5	12	22	1.614	2.244	1.334
208-1PDL-622	90 1/2	22MM X 1.5	15	27	1.890	2.717	1.557
210-1PDL-626	90 5/8	26MM X 1.5	18	32	2.185	3.071	1.911

METRIC SWIVEL FEMALE STEM DIN 20078 LIGHT STRAIGHT W/ O-RING

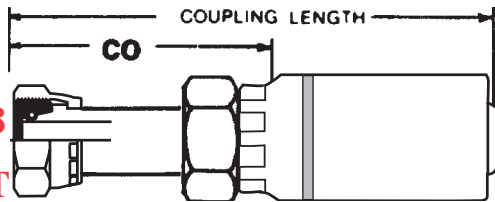

Part Number	Hose I.D.	Thread	DIN Tube O.D.(mm)	Nut Hex (mm)	Fitting Length	-CO-Cutoff
204-1PDL-612	1/4	12MM X 1.5	6	17	1.850	.940
204-1PDL-614	1/4	14MM X 1.5	8	17	1.811	.901
206-1PDL-616	3/8	16MM X 1.5	10	19	1.831	.921
206-1PDL-618	3/8	18MM X 1.5	12	22	1.870	.960
208-1PDL-622	1/2	22MM X 1.5	15	27	2.244	1.084
210-1PDL-626	5/8	26MM X 1.5	18	32	2.264	1.104

One-Piece British Standard and Metric Fittings for SAE 100R1AT and 100R2AT

1P



SOLID MALE STEM DIN 20078 HEAVY 12° SEAT

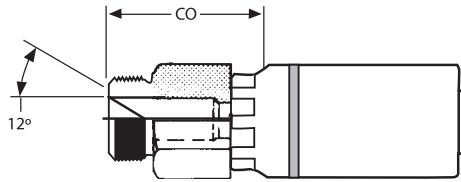

Part Number	Hose I.D.	Thread	Hex	Fitting Length	-CO-Cutoff
204-1PDH-116	1/4	16MM X 1.5	11/16	1.793	.883
204-1PDH-118	1/4	18MM X 1.5	3/4	1.793	.883
206-1PDH-120	3/8	20MM X 1.5	7/8	1.870	.960
206-1PDH-122	3/8	22MM X 1.5	7/8	1.910	1.000
208-1PDH-124	1/2	24MM X 1.5	1	2.272	1.112
412-1PDH-136	3/4	36MM X 2	1-1/2	3.231	1.376
416-1PDH-142	1	42MM X 2	1.3/4	3.615	1.565

METRIC SWIVEL FEMALE STEM DIN 20078 HEAVY 45° BENT TUBE W/ O-RING & 12/30° UNIV. CONE

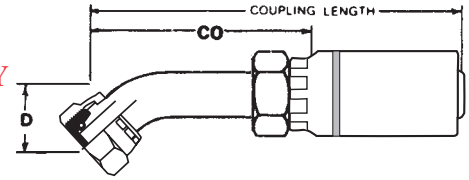

Part Number	Hose I.D.	Thread	DIN Tube O.D.(mm)	Nut Hex (mm)	-D-Drop	Fitting Length	-CO-Cutoff
204-1PDH-618 45	1/4	18MM X 1.5	10	22	.807	2.421	1.511
206-1PDH-620 45	3/8	20MM X 1.5	12	24	.984	2.815	1.905
206-1PDH-622 45	3/8	22MM X 1.5	14	27	.906	2.736	1.826
208-1PDH-624 45	1/2	24MM X 1.5	16	30	.945	3.150	1.990
210-1PDH-630 45	5/8	30MM X 2	20	36	1.240	3.622	2.462

METRIC SWIVEL FEMALE STEM DIN 20078 HEAVY STRAIGHT W/ O-RING & 12/30° UNIV. CONE

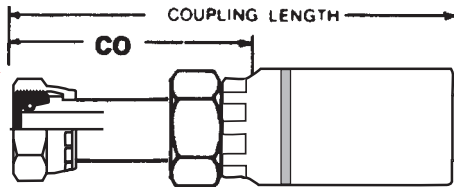

Part Number	Hose I.D.	Thread	DIN Tube O.D.(mm)	Nut Hex (mm)	Fitting Length	-CO-Cutoff
204-1PDH-616	1/4	16MM X 1.5	8	19	1.850	.940
204-1PDH-618	1/4	18MM X 1.5	10	22	1.890	.980
206-1PDH-618	3/8	18MM X 1.5	10	22	1.890	.980
206-1PDH-620	3/8	20MM X 1.5	12	24	2.106	1.196
206-1PDH-622	3/8	22MM X 1.5	14	27	1.969	1.059
208-1PDH-624	1/2	24MM X 1.5	16	30	2.165	1.005
210-1PDH-630	5/8	30MM X 2	20	36	2.520	1.360

METRIC SWIVEL FEMALE STEM DIN 20078 HEAVY 90° BENT TUBE W/ O-RING & 12/30° UNIV. CONE

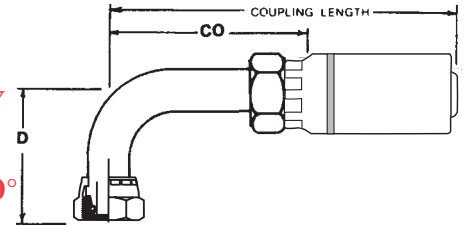

Part Number	Hose I.D.	Thread	DIN Tube O.D.(mm)	Nut Hex (mm)	-D-Drop	Fitting Length	-CO-Cutoff
204-1PDH-616 90	1/4	16MM X 1.5	8	19	1.378	1.929	1.019
204-1PDH-618 90	1/4	18MM X 1.5	10	22	1.437	1.929	1.019
206-1PDH-618 90	3/8	18MM X 1.5	10	22	1.594	2.244	1.334
206-1PDH-620 90	3/8	20MM X 1.5	12	24	1.811	2.244	1.334
206-1PDH-622 90	3/8	22MM X 1.5	14	27	1.693	2.244	1.334
208-1PDH-624 90	1/2	24MM X 1.5	16	30	1.831	2.717	1.557
210-1PDH-630 90	5/8	30MM X 2	20	36	2.461	3.071	1.911



Reusable Hose Fittings— Non-Mandrel Type for SAE 100R5 Hose—DOT FMVSS 106 TYPE AII

“ASSEMBLY INSTRUCTIONS NON-MANDREL TYPE FITTINGS — SAE 100R5 HOSE”

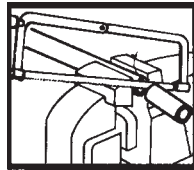

1. Cut hose square to desired length using fine-tooth hacksaw or cut-off wheel.

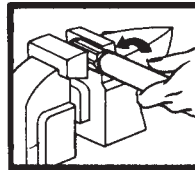

2. Hold socket securely with wrench or place in vise, if available, and screw hose in counter-clockwise using body weight to start threading.

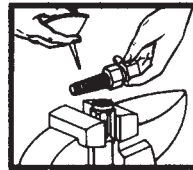

3. Oil inside of hose and socket threads. This lubrication makes assembly much easier.

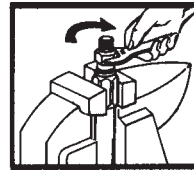

4. Screw nipple into socket using wrench on hex of nipple.

NPTF SOLID MALE REUSALBE NON-MANDREL FOR SAE 100R5 HOSE

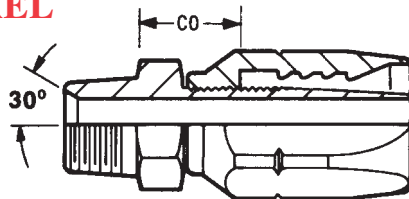

Part Number	Hose I.D.	Thread	Hex	Stem I.D.	Fitting Length	-CO-Cutoff
204-5RU-102	3/16	1/8 - 27	9/16	.125	1.672	.922
204-5RU-104	3/16	1/4 - 18	9/16	.125	1.860	1.110
205-5RU-104	1/4	1/4 - 18	9/16	.172	1.969	1.187
206-5RU-104	5/16	1/4 - 18	9/16	.234	2.172	1.234
206-5RU-106	5/16	3/8 - 18	11/16	.234	2.203	1.266
208-5RU-106	13/32	3/8 - 18	11/16	.344	2.485	1.328
208-5RU-108	13/32	1/2 - 14	7/8	.344	2.781	1.562
210-5RU-108	1/2	1/2 - 14	7/8	.453	2.860	1.594
210-5RU-112	1/2	3/4 - 14	1-1/16	.453	2.860	1.656
212-5RU-112	5/8	3/4 - 14	1-1/16	.562	3.203	1.672
220-5RU-120	1-1/8	1-1/4 - 11-1/2				

JIC 37° SOLID MALE REUSABLE NON-MANDREL FOR SAE 100R5 HOSE

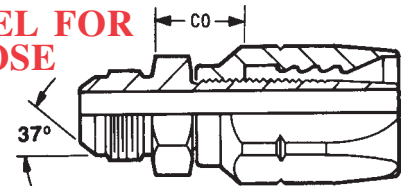

Part Number	Hose I.D.	Thread	Hex	Stem I.D.	Fitting Length	-CO-Cutoff
204-5RU-504	3/16	7/16 - 20	1/2	.125	1.844	1.094
205-5RU-505	1/4	1/2 - 20	9/16	.172	1.953	1.172
206-5RU-506	5/16	9/16 - 18	5/8	.234	2.125	1.219
208-5RU-508	13/32	3/4 - 16	13/16	.360	2.562	1.312
210-5RU-510	1/2	7/8 - 14	15/16	.453	2.891	1.500
212-5RU-512	5/8	1-1/16 - 12	1-1/8	.578	3.344	1.781
216-5RU-516	7/8	1-5/16 - 12	1-3/8	.812	2.937	1.687

SAE 45° SWIVEL FEMALE REUSABLE NON-MANDREL FOR SAE 100R5 HOSE

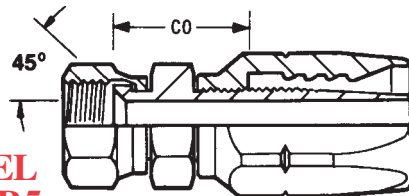

Part Number	Hose I.D.	Thread	Stem Hex	Nut Hex	Stem I.D.	Fitting Length	-CO-Cutoff
206-5RU-406	5/16	5/8 - 18	3/4	3/4	.234	2.344	1.437
212-5RU-412	5/8	1-1/16 - 14	1-1/4	1-1/4	.562	3.500	1.922

ORB SOLID MALE REUSABLE NON-MANDREL FOR SAE 100R5 HOSE

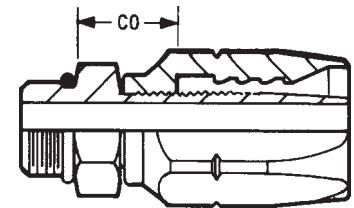

Part Number	Hose I.D.	Thread	Hex	Stem I.D.	Fitting Length	-CO-Cutoff
204-5RU-704	3/16	7/16 - 20	9/16	.125	1.641	.891
205-5RU-705	1/4	1/2 - 20	5/8	.172	1.750	.969
206-5RU-706	5/16	9/16 - 18	11/16	.234	1.937	1.031
208-5RU-708	13/32	3/4 - 16	7/8	.344	2.344	1.094
210-5RU-710	1/2	7/8 - 14	1	.453	2.625	1.234
212-5RU-712	5/8	1-1/16 - 12	1-1/4	.562	3.094	1.531
216-5RU-716	7/8	1-5/16 - 12	1-1/2	.812	2.656	1.391

Reusable Hose Fittings— Non-Mandrel Type for SAE 100R5 Hose



**JIC 37°
SWIVEL
FEMALE
REUSABLE
NON-MANDREL
FOR SAE 100R5
HOSE**

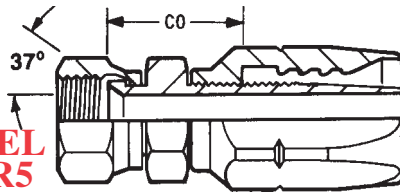

Part Number	Hose I.D.	Thread	Stem Hex	Nut Hex	Stem I.D.	Fitting Length	-CO-Cutoff
204-5RU-604	3/16	7/16 - 20	9/16	9/16	.125	1.937	1.187
205-5RU-605	1/4	1/2 - 20	5/8	5/8	.172	2.078	1.297
206-5RU-606	5/16	9/16 - 18	11/16	11/16	.234	2.312	1.406
208-5RU-608	13/32	3/4 - 16	7/8	7/8	.344	2.844	1.578
210-5RU-610	1/2	7/8 - 14	1	1	.453	3.062	1.672
212-5RU-612	5/8	1-1/16 - 12	1-1/4	1-1/4	.562	3.500	1.922
216-5RU-616	7/8	1-5/16 - 12	1-1/2	1-1/2	.812	3.187	1.922
220-5RU-620	1-1/8	1-5/8 - 12	2	2	1.047	3.375	2.031
224-5RU-624	1-3/8	1-7/8 - 12	2-1/4	2-1/4	1.281	3.656	2.244
232-5RU-632	1-13/16	2-1/2 - 12	2-7/8	2-7/8	1.750	4.437	2.578

**JIC 37°
SWIVEL
FEMALE
REUSABLE
90° BENT
TUBE
MEDIUM
DROP
NON-MANDREL
FOR SAE 100R5
HOSE**

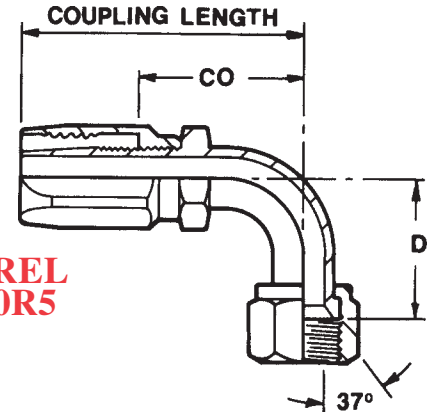

Part Number	Hose I.D.	Thread	Nut Hex	-D-Drop	Fitting Length	-CO-Cutoff
204-5RU-664	3/16	7/16 - 20	9/16	.690	1.750	1.000
205-5RU-665	1/4	1/2 - 20	5/8	.760	1.970	1.190
206-5RU-666	5/16	9/16 - 18	11/16	.840	2.120	1.230
208-5RU-668	13/32	3/4 - 16	7/8	1.090	2.750	1.610
210-5RU-670	1/2	7/8 - 14	1	1.230	2.940	1.660
212-5RU-672	5/8	1-1/16 - 12	1-1/4	1.810	3.750	2.170
216-5RU-676	7/8	1-5/16 - 12	1-1/2	2.140	3.550	2.280

**JIC 37°
SWIVEL
FEMALE
REUSABLE
45° BENT
TUBE
MEDIUM
DROP
NON-MANDREL
FOR SAE 100R5
HOSE**

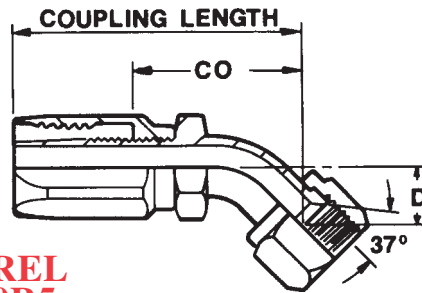

Part Number	Hose I.D.	Thread	Nut Hex	-D-Drop	Fitting Length	-CO-Cutoff
204-5RU-684	3/16	7/16 - 20	9/16	.330	1.840	1.110
205-5RU-685	1/4	1/2 - 20	5/8	.360	1.060	1.280
206-5RU-686	5/16	9/16 - 18	11/16	.390	2.230	1.330
208-5RU-688	13/32	3/4 - 16	7/8	.550	2.980	1.840
210-5RU-690	1/2	7/8 - 14	1	.630	3.230	1.950
212-5RU-692	5/8	1-1/16 - 12	1-1/4	.770	3.780	2.220
216-5RU-696	7/8	1-5/16 - 12	1-1/2	.890	3.560	2.230

**JIC 37°
SWIVEL
FEMALE
REUSABLE
90° BENT
TUBE
LONG DROP
NON-MANDREL
FOR SAE 100R5
HOSE**

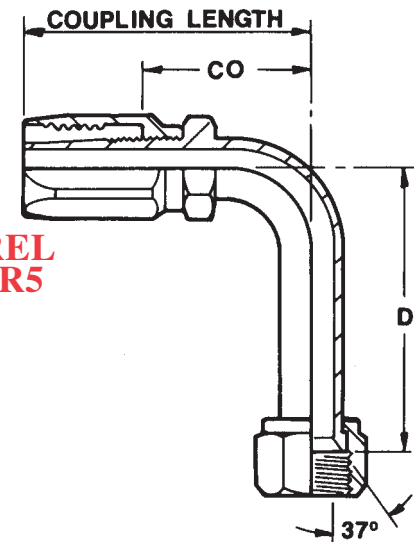

Part Number	Hose I.D.	Thread	Nut Hex	-D-Drop	Fitting Length	-CO-Cutoff
204-5RL-664	3/16	7/16 - 20	9/16	1.800	1.750	1.000
205-5RL-665	1/4	1/2 - 20	5/8	1.780	1.970	1.190
206-5RL-666	5/16	9/16 - 18	11/16	2.190	2.120	1.230
208-5RL-668	13/32	3/4 - 16	7/8	2.440	2.750	1.610
210-5RL-670	1/2	7/8 - 14	1	2.560	2.940	1.660
212-5RL-672	5/8	1-1/16 - 12	1-1/4	3.730	3.750	2.170
216-5RL-676	7/8	1-5/16 - 12	1-1/2	4.330	3.550	2.280



Reusable Hose Fittings Skive Type for SAE 100R2A Hose

“ASSEMBLY INSTRUCTIONS SKIVE TYPE FITTINGS–SAE 100R2A”

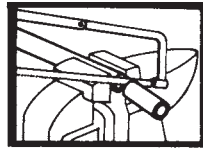

1. Cut hose to desired length using fine tooth hacksaw or cut-off wheel.



2. Determine length of hose to be reduced to socket diameter and score with sharp knife.

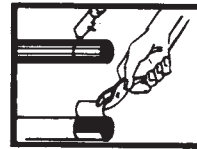

3. After slitting the rubber cover, twist off with pliers. If any particles of rubber remain, remove with wire brush.

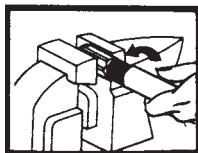

4. Place socket in vise and screw hose in counter-clockwise, using body weight against hose to start threading. Tighten until hose bottoms, then back off ¼ turn.

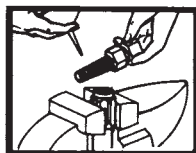

5. Oil inside of hose and nipple threads.

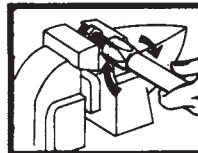

6. Place nipple in vise. Push and turn socket, with hose inserted, clockwise on to stem until threads engage.

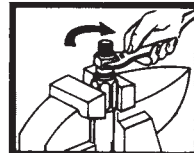

7. Screw nipple into socket, using wrench on hex of nipple. After assembled, blow out with air pressure to remove any loose particles and inspect.

NOTE: Some fitting sockets have annular grooves: in this case push down on hose while turning hose into socket, using an alternating motion of a quarter turn in each direction.

NPTF SOLID MALE REUSABLE SKIVE TYPE FOR SAE 100R2A HOSE

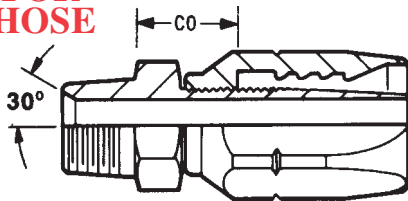

Part Number	Hose I.D.	Thread	Hex	Stem I.D.	Fitting Length	-CO-Cutoff
204-2RU-102	1/4	1/8 - 27	9/16	.172	2.344	1.125
204-2RU-104	1/4	1/4 - 18	9/16	.172	2.562	1.344
206-2RU-104	3/8	1/4 - 18	11/16	.297	2.781	1.312
206-2RU-106	3/8	3/8 - 18	11/16	.297	2.781	1.312
208-2RU-106	1/2	3/8 - 18	7/8	.375	2.937	1.375
208-2RU-108	1/2	1/2 - 14	7/8	.375	3.125	1.562
212-2RU-112	3/4	3/4 - 14	1-1/16	.594	3.656	1.750
216-2RU-116	1	1 - 11-1/2	1-3/8	.812	4.344	2.281
220-2RU-120	1-1/4	1-1/4 - 11-1/2	1-3/4	1.047	4.937	2.594
224-2RU-124	1-1/2	1-1/2 - 11-1/2	2	1.281	5.000	2.687
232-2RU-132	2	2 - 11-1/2	2-1/2	1.750	5.344	2.844

JIC 37° SOLID MALE REUSABLE SKIVE TYPE FOR SAE 100R2A HOSE

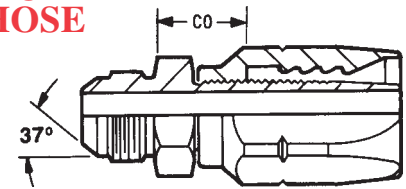

Part Number	Hose I.D.	Thread	Hex	Stem I.D.	Fitting Length	-CO-Cutoff
204-2RU-504	1/4	7/16 - 20	9/16	.172	2.531	1.297
204-2RU-505	1/4	1/2 - 20	9/16	.172	2.531	1.297
204-2RU-506	1/4	9/16 - 18	9/16	.172	2.547	1.312
206-2RU-506	3/8	9/16 - 18	11/16	.297	2.750	1.281
206-2RU-508	3/8	3/4 - 16	7/8	.297	2.891	1.437
208-2RU-508	1/2	3/4 - 16	7/8	.375	3.031	1.469
208-2RU-510	1/2	7/8 - 14	7/8	.375	3.141	1.594
212-2RU-512	3/4	1-1/16 - 12	1-1/8	.594	3.781	1.875
216-2RU-516	1	1-5/16 - 12	1-3/8	.812	4.344	2.281
220-2RU-520	1-1/4	1-5/8 - 12	1-3/4	1.047	4.875	2.562
224-2RU-524	1-1/2	1-7/8 - 12	2	1.281	5.128	2.812

Reusable Hose Fittings— Skive Type for SAE 100R2A Hose



JIC 37° SWIVEL FEMALE REUSEABLE-SKIVE TYPE FOR SAE 100R2A HOSE

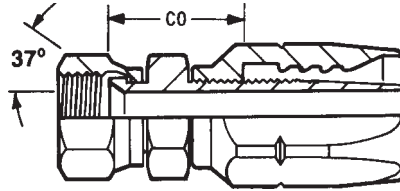

Part Number	Hose I.D.	Thread	Stem Hex	Nut Hex	Stem I.D.	Fitting Length	-CO-Cutoff
204-2RU-604	1/4	7/16 - 20	9/16	9/16	.172	2.625	1.375
204-2RU-605	1/4	1/2 - 20	5/8	5/8	.172	2.672	1.422
204-2RU-606	1/4	9/16 - 18	11/16	11/16	.172	2.781	1.547
206-2RU-606	3/8	9/16 - 18	11/16	11/16	.297	2.953	1.500
206-2RU-608	3/8	3/4 - 16	7/8	7/8	.297	3.094	1.625
208-2RU-608	1/2	3/4 - 16	7/8	7/8	.375	3.234	1.672
208-2RU-610	1/2	7/8 - 14	1	1	.375	3.328	1.766
212-2RU-612	3/4	1-1/16 - 12	1-1/4	1-1/4	.594	3.891	2.000
212-2RU-614	3/4	1-3/16 - 12	1-3/8	1-3/8	.594	3.969	2.078
216-2RU-616	1	1-5/16 - 12	1-1/2	1-1/2	.812	4.453	2.437
220-2RU-620	1-1/4	1-5/8 - 12	2	2	1.047	5.141	2.781
220-2RU-624	1-1/2	1-7/8 - 12	2-1/4	2-1/4	1.281	.219	2.969
232-2RU-632	2	2-1/2 - 12	2-7/8	2-7/8	1.750	5.906	3.437

“O” RING SEAL-TUBE END MALE REUSEABLE-SKIVE TYPE FOR SAE 100R2A HOSE

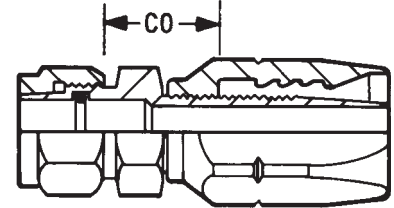

Part Number	Hose I.D.	Tube Size	Stem Hex	Stem I.D.	Fitting Length	-CO-Cutoff
204-ORS-04	1/4	1/4	9/16	.172	2.672	1.437
206-ORS-06	3/8	3/8	11/16	.297	2.984	1.531
206-ORS-08	3/8	1/2	7/8	.297	2.234	1.781
208-ORS-08	1/2	1/2	7/8	.375	3.375	1.812
208-ORS-10	1/2	5/8	1	.375	3.531	1.937
212-ORS-12	3/4	3/4	1-1/8	.594	4.125	2.219
216-ORS-16	1	1	1-1/2	.812	4.750	2.719
220-ORS-20	1-1/4	1-1/4	1-3/4	1.047	5.578	3.250
224-ORS-24	1-1/2	1-1/2	2	1.281	5.844	3.531

ORB SOLID MALE REUSEABLE SKIVE TYPE FOR SAE 100R2A HOSE

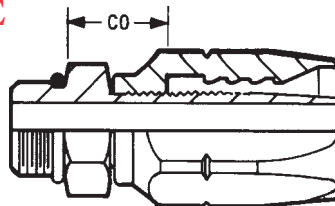

Part Number	Hose I.D.	Thread	Hex	Stem I.D.	Fitting Length	-CO-Cutoff
204-2RU-704	1/4	7/16 - 20	9/16	.172	2.344	1.109
206-2RU-706	3/8	9/16 - 18	11/16	.297	2.609	1.156
206-2RU-708	3/8	3/4 - 16	7/8	.297	2.687	1.219
208-2RU-708	1/2	3/4 - 16	7/8	.375	2.844	1.297
208-2RU-710	1/2	7/8 - 14	1	.375	2.937	1.391
212-2RU-712	3/4	1-1/16 - 12	1-1/4	.594	3.500	1.594
216-2RU-716	1	1-5/16 - 12	1-1/2	.812	3.953	1.906



Ferrules for SAE 100R7 Thermoplastic Hose

**FERRULE
FOR SAE
100R7—
MEDIUM
O.D. HOSE**

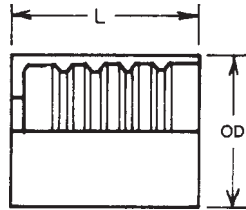

Part Number	Hose I.D.	-L-	-O.D.-	-I.D.-
727	1/8	.750	.500	.345
737	3/16	.812	.720	.470
747	1/4	.812	.687	.530
757	5/16	.812	.785	.620
767	3/8	.812	.930	.690
787	1/2	.875	1.063	.855

Stems for SAE 100R7 Thermoplastic Hose



NPTF SOLID MALE STEM

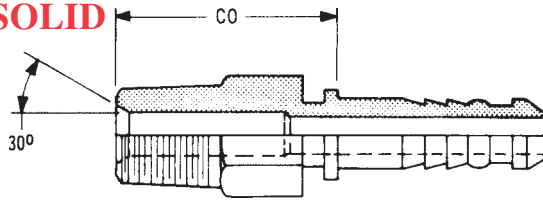

Part Number	Hose I.D.	Thread	Hex	Stem I.D.	Fitting Length	-CO-Cutoff
703-102	3/16	1/8 - 27	1/2	.125	1.718	.843
703-104	3/16	1/4 - 18	9/16	.125	1.906	1.031
704-102	1/4	1/8 - 27	5/8	.156	1.718	.843
704-104	1/4	1/4 - 18	5/8	.156	1.906	1.031
704-106	1/4	3/8 - 18	11/16	.156	1.937	1.062
704-108	1/4	1/2 - 14	7/8	.156	2.187	1.312
705-104	5/16	1/4 - 18	5/8	.234	1.906	1.031
706-104	3/8	1/4 - 18	11/16	.281	1.937	1.062
706-106	3/8	3/8 - 18	11/16	.281	1.937	1.062
706-108	3/8	1/2 - 14	7/8	.281	2.187	1.312
708-106	1/2	3/8 - 18	3/4	.392	2.062	1.187
708-108	1/2	1/2 - 14	7/8	.392	2.250	1.375

NPTF SWIVEL MALE STEM

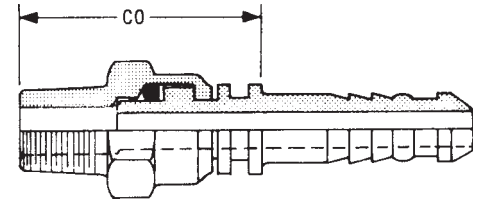

Leakage may occur at low pressure

Part Number	Hose I.D.	Thread	Nut Hex	Stem I.D.	Fitting Length	-CO-Cutoff
704-204	1/4	1/4 - 18	11/16	.156	2.315	1.440
704-206	1/4	3/8 - 18	13/16	.156	2.480	1.605
705-204	5/16	1/4 - 18	11/16	.234	2.338	1.463
706-206	3/8	3/8 - 18	13/16	.281	2.487	1.612
706-208	3/8	1/2 - 14	7/8	.281	2.665	1.790
708-206	1/2	3/8 - 18	1	.281	2.532	1.657
708-208	1/2	1/2 - 14	1	.406	2.730	1.855

NPTF SOLID MALE STEM STAINLESS STEEL TYPE 303

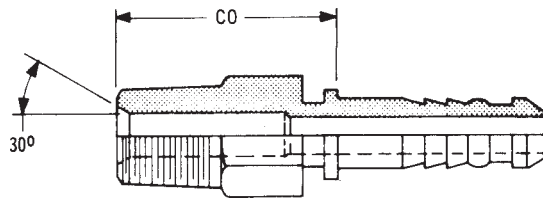

Part Number	Hose I.D.	Thread	Hex	Stem I.D.	Fitting Length	-CO-Cutoff
704-SS-104	1/4	1/4 - 18	5/8	.155	1.906	1.030
706-SS-104	3/8	1/4 - 18	11/16	.281	1.906	1.030
706-SS-106	3/8	3/8 - 18	11/16	.281	1.936	1.061
708-SS-108	1/2	1/2 - 14	7/8	.392	2.250	1.375

NPTF SWIVEL MALE-90° STEM

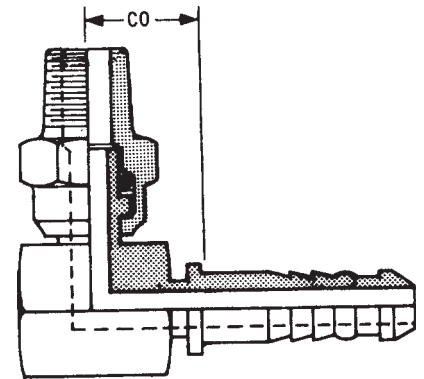

Leakage may occur at low pressure

Part Number	Hose I.D.	Thread	Nut Hex	-D-Drop	Stem I.D.	Fitting Length	-CO-Cutoff
704-204 90	1/4	1/4 - 18	11/16	1.536	.156	1.937	1.062

NPTF SOLID MALE STEM STAINLESS STEEL TYPE 316

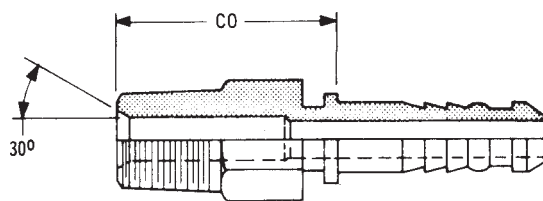

Part Number	Hose I.D.	Thread	Hex	Stem I.D.	Fitting Length	-CO-Cutoff
704-S16-104	1/4	1/4 - 18	5/8	.155	1.906	1.030
706-S16-104	3/8	1/4 - 18	11/16	.281	1.906	1.030
706-S16-106	3/8	3/8 - 18	11/16	.281	1.936	1.061
708-S16-108	1/2	1/2 - 14	7/8	.392	2.250	1.375

JIC 37° SOLID MALE STEM

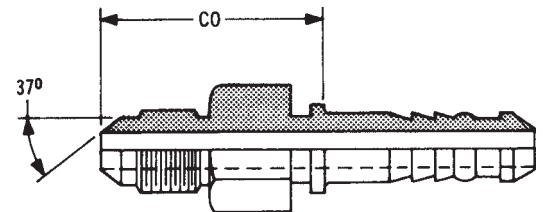

Part Number	Hose I.D.	Thread	Hex	Stem I.D.	Fitting Length	-CO-Cutoff
703-504	3/16	7/16 - 20	1/2	.125	1.880	1.013
704-504	1/4	7/16 - 20	5/8	.156	1.880	1.013
704-505	1/4	1/2 - 20	5/8	.156	1.888	1.013
704-506	1/4	9/16 - 18	5/8	.156	1.904	1.029
705-506	5/16	9/16 - 18	5/8	.234	1.898	1.023
706-506	3/8	9/16 - 18	11/16	.281	1.936	1.062
706-508	3/8	3/4 - 16	3/4	.281	2.030	1.155
708-508	1/2	3/4 - 16	13/16	.390	2.156	1.219
708-510	1/2	7/8 - 14	7/8	.390	2.250	1.313



Stems for SAE 100R7 Thermoplastic Hose

JIC 37° SWIVEL FEMALE STEM

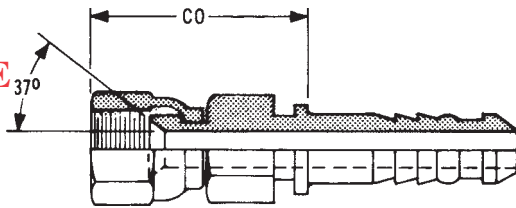

Part Number	Hose I.D.	Thread	Stem Hex	Nut Hex	Stem I.D.	Fitting Length	-CO-Cutoff
702-604	1/8	7/16 - 20	1/2	9/16	.070	1.665	.980
703-603	3/16	3/8 - 24	1/2	1/2	.125	1.960	1.084
703-604	3/16	7/16 - 20	1/2	9/16	.125	1.940	1.068
704-604	1/4	7/16 - 20	5/8	9/16	.156	1.954	1.084
704-605	1/4	1/2 - 20	5/8	11/16	.156	2.015	1.125
704-606	1/4	9/16 - 18	5/8	3/4	.156	2.018	1.142
705-606	5/16	9/16 - 18	5/8	3/4	.234	2.004	1.118
706-606	3/8	9/16 - 18	11/16	3/4	.281	2.034	1.151
706-608	3/8	3/4 - 16	11/16	7/8	.281	2.134	1.261
706-610	3/8	7/8 - 14	13/16	1-1/16	.281	2.210	1.345
708-608	1/2	3/4 - 16	13/16	7/8	.390	2.284	1.350
708-610	1/2	7/8 - 14	13/16	1-1/16	.390	2.364	1.434

ORB SOLID MALE STEM

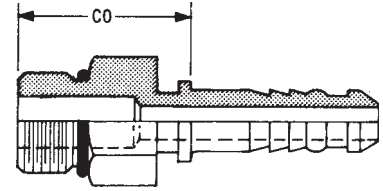

Part Number	Hose I.D.	Thread	Hex	Stem I.D.	Fitting Length	-CO-Cutoff
704-705	1/4	1/2 - 20	5/8	.156	1.703	.827
704-706	1/4	9/16 - 18	3/4	.156	1.734	.859
706-706	3/8	9/16 - 18	3/4	.281	1.827	.952
706-708	3/8	3/4-16	7/8	.281	1.902	1.027
708-710	1/2	7/8 - 14	1	.390	2.000	1.062

ORB SWIVEL MALE 90° STEM

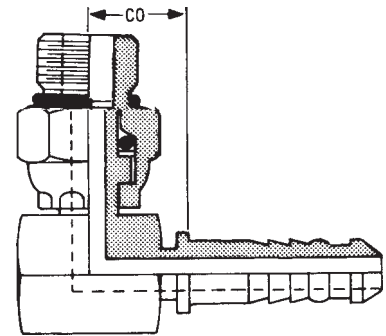

Leakage may occur at low pressure

Part Number	Hose I.D.	Thread	Stem Hex	Nut Hex	Stem I.D.	Fitting Length	-CO-Cutoff
706-806 90	3/8	9/16 - 18	11/16	1.426	.281	1.575	.740

JIC 37° SWIVEL FEMALE STEM STAINLESS STEEL TYPE 303

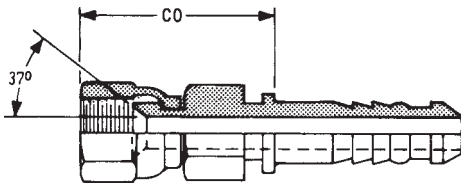

Part Number	Hose I.D.	Thread	Stem Hex	Nut Hex	Stem I.D.	Fitting Length	-CO-Cutoff
704-SS-604	1/4	7/16 - 20	5/8	9/16	.156	1.950	1.085
704-SS-606	1/4	9/16 - 18	5/8	3/4	.156	2.010	1.140
706-SS-606	3/8	9/16 - 18	11/16	3/4	.281	2.200	1.150
706-SS-608	3/8	3/4 - 16	11/16	7/8	.281	2.120	1.260
708-SS-608	1/2	3/4 - 16	13/16	7/8	.390	2.230	1.300
708-SS-610	1/2	7/8 - 14	13/16	1-1/16	.390	2.320	1.390

NPTF SOLID FEMALE STEM

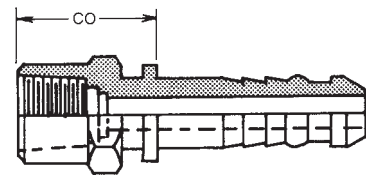

Part Number	Hose I.D.	Thread	Hex	Stem I.D.	Fitting Length	-CO-Cutoff
704-904	1/4	1/4 - 18	5/8	.156	1.750	.875
706-906	3/8	3/8 - 18	13/16	.281	1.812	.937
708-908	1/2	1/2 - 14	1	.390	2.077	1.140

JIC 37° SWIVEL FEMALE STEM STAINLESS STEEL TYPE 316

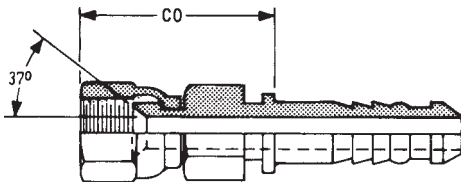

Part Number	Hose I.D.	Thread	Stem Hex	Nut Hex	Stem I.D.	Fitting Length	-CO-Cutoff
704-S16-604	1/4	7/16 - 20	5/8	9/16	.156	1.950	1.085
704-S16-606	1/4	9/16 - 18	5/8	3/4	.156	2.010	1.140
706-S16-606	3/8	9/16 - 18	11/16	3/4	.281	2.200	1.150
706-S16-608	3/8	3/4 - 16	11/16	7/8	.281	2.120	1.260
708-S16-608	1/2	3/4 - 16	13/16	7/8	.390	2.230	1.300
708-S16-610	1/2	7/8 - 14	13/16	1-1/16	.390	2.320	1.390

NPSM SWIVEL FEMALE STEM

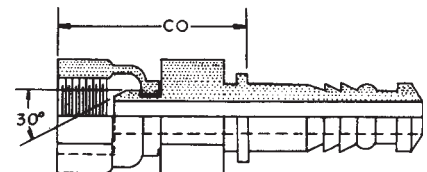

Part Number	Hose I.D.	Thread	Stem Hex	Nut Hex	Stem I.D.	Fitting Length	-CO-Cutoff
703-4 FPX	3/16	1/4 - 18	1/2	11/16	.125	1.794	.919
704-4 FPX	1/4	1/4 - 18	5/8	11/16	.156	1.850	.985
706-6 FPX	3/8	3/8 - 18	11/16	7/8	.234	2.027	1.153

Stems for SAE 100R7 Thermoplastic Hose



TUBE STEM

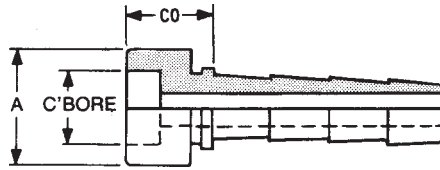

Part Number	Hose I.D.	C' Bore DIA	C' Bore Depth	-A- O.D.	Stem I.D.	Fitting Length	-CO- Cutoff
703-T03	3/16	3/16	.218	1/2	.125	1.437	.562
703-T04	3/16	1/4	.218	1/2	.125	1.437	.562
703-T05	3/16	5/16	.218	.604	.156	1.437	.562
704-T04	1/4	1/4	.218	.604	.156	1.437	.562
704-T05	1/4	5/16	.218	.604	.156	1.437	.562
704-T06	1/4	3/8	.218	.604	.156	1.437	.562
705-T06	5/16	3/8	.218	5/8	.234	1.437	.562
706-T06	3/8	3/8	.218	3/4	.296	1.437	.562
708-T06	1/2	3/8	.218	7/8	.361	1.500	.562
708-T08	1/2	1/2	.218	7/8	.361	1.500	.562
708-T10	1/2	5/8	.218	7/8	.361	1.500	.562
708-T12	1/2	3/4	.218	7/8	.361	1.500	.562

JIC 37° SWIVEL FEMALE STEM 90° BENT TUBE MEDIUM DROP

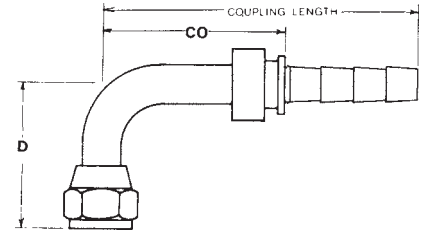

Part Number	Hose I.D.	Thread	Nut Hex	-D- Drop	Fitting Length	-CO- Cutoff
704-M-664	1/4	7/16 - 20	9/16	.920	2.350	1.470
705-M-666	5/16	9/16 - 18	11/16	1.130	2.590	1.710
706-M-666	3/8	9/16 - 18	11/16	1.130	2.590	1.710

JIC 37° SWIVEL FEMALE STEM 45° BENT TUBE SHORT DROP

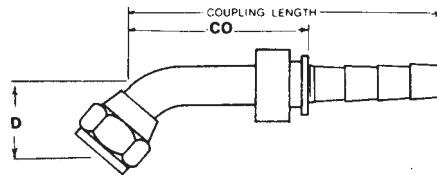

Part Number	Hose I.D.	Thread	Nut Hex	-D- Drop	Fitting Length	-CO- Cutoff
703-S-684	3/16	7/16 - 20	9/16	.330	2.520	1.650
704-S-684	1/4	7/16 - 20	9/16	.330	2.570	1.690
706-S-686	3/8	9/16 - 18	11/16	.410	2.930	2.050

JIC 37° SWIVEL FEMALE STEM 90° BENT TUBE LONG DROP

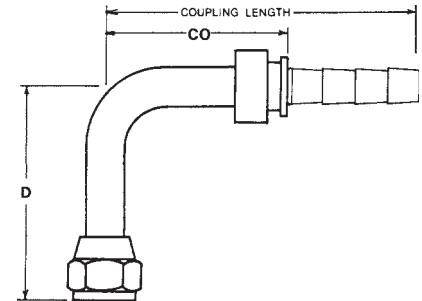

Part Number	Hose I.D.	Thread	Nut Hex	-D- Drop	Fitting Length	-CO- Cutoff
703-L-664	3/16	7/16 - 20	9/16	1.800	2.300	1.430
704-L-664	1/4	7/16 - 20	9/16	1.800	2.350	1.470
706-L-666	3/8	9/16 - 18	11/16	2.180	2.590	1.710
708-L-672	1/2	1-1/16 - 12	11-1/4	3.730	3.650	2.710

JIC 37° SWIVEL FEMALE STEM 90° BENT TUBE SHORT DROP

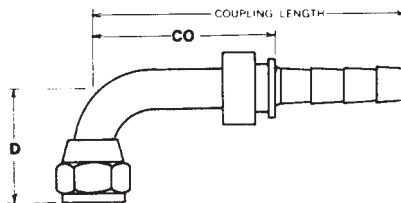

Part Number	Hose I.D.	Thread	Nut Hex	-D- Drop	Fitting Length	-CO- Cutoff
703-S-664	3/16	7/16 - 20	9/16	.780	1.390	
704-S-664	1/4	7/16 - 20	9/16	.780	2.350	1.470
704-S-666	1/4	9/16 - 18	11/16	.780	2.590	1.710
706-S-666	3/8	9/16 - 18	11/16	.780	2.590	1.710
708-S-668	1/2	3/4 - 16	7/8	1.170	2.820	1.880
708-S-670	1/2	7/8 - 14	1	1.320	3.060	2.210



Ferrules for Three Wire Braid & SAE 100R12 Hydraulic Hose

THREE WIRE AND 100R12 STEEL FERRULE SKIVE REQUIRED

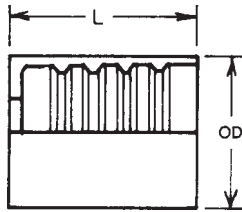

Part Number	Hose I.D.	-L-	-O.D.-	-I.D.-
504-500	1/4	1.000	.873	.630
208-200	3/8	1.250	1.125	.883
408-400	1/2	1.470	1.280	.980
410-400	5/8	1.493	1.362	1.062
412-400	3/4	1.969	1.495	1.206
416-400	1	2.066	1.870	1.560
420-400	1-1/4	2.210	2.250	1.912
424-400	1-1/2	2.580	2.562	2.200
432-400	2	3.070	3.125	2.690

THREE WIRE AND 100R12 STAINLESS STEEL FERRULE TYPE 303 SKIVE REQUIRED

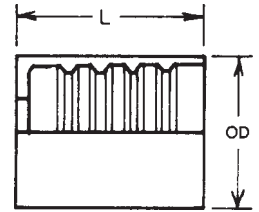

Part Number	Hose I.D.	-L-	-O.D.-	-I.D.-
408-SS-400	1/2	1.470	1.280	.980
410-SS-400	5/8	1.493	1.362	1.062
412-SS-400	3/4	1.969	1.495	1.206
416-SS-400	1	2.066	1.870	1.560
420-SS-400	1-1/4	2.210	2.250	1.912
424-SS-400	1-1/2	2.580	2.562	2.200
432-SS-400	2	3.070	3.125	2.690

100R12 NON-SKIVE STEEL FERRULE

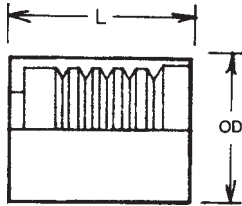

Part Number	Hose I.D.	-L-	-O.D.-
406-500	3/8	1.000	1.230
408-500	1/2	1.470	1.350
412-500	3/4	1.975	1.650
416-500	1	2.070	1.975
420-500	1-1/4	2.375	2.430
424-500	1-1/2	2.750	2.750
432-500	2	3.070	3.340

THREE WIRE AND 100R12 STAINLESS STEEL FERRULE TYPE 316 SKIVE REQUIRED

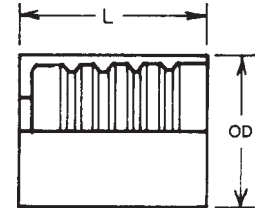

Part Number	Hose I.D.	-L-	-O.D.-	-I.D.-
408-S16-400	1/2	1.470	1.280	.980
410-S16-400	5/8	1.493	1.362	1.062
412-S16-400	3/4	1.969	1.495	1.206
416-S16-400	1	2.066	1.870	1.560
420-S16-400	1-1/4	2.210	2.250	1.912
424-S16-400	1-1/2	2.580	2.562	2.200
432-S16-400	2	3.070	3.125	2.690

Stems for SAE 100R12, Three Wire Braid & Spiral Hydraulic Hose



NPTF SOLID MALE STEM

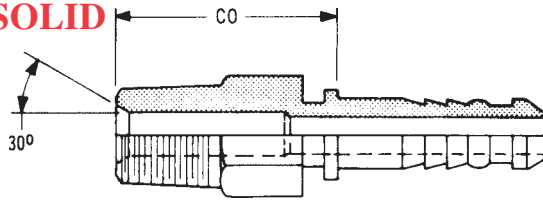

Part Number	Hose I.D.	Thread	Hex	Stem I.D.	Fitting Length	-CO-Cutoff
204-104	1/4	1/4 - 18	5/8	.156	1.940	1.030
206-106	3/8	3/8 - 18	11/16	.296	1.971	1.061
208-108	1/2	1/2 - 14	7/8	.406	2.472	1.312
412-112	3/4	3/4 - 14	1-1/16	.625	3.281	1.426
416-112	1	3/4 - 14	1-3/8	.655	3.565	1.515
416-116	1	1 - 11-1/2	1-3/8	.843	3.752	1.702
220-120	1-1/4	1-1/4 - 11-1/2	1-3/4	1.062	3.943	2.020
224-124	1-1/2	1-1/2 - 11-1/2	2	1.311	4.520	2.182
232-132	2	2 - 11-1/2	2-1/2	1.655	5.500	2.329

JIC 37° SOLID MALE STEM

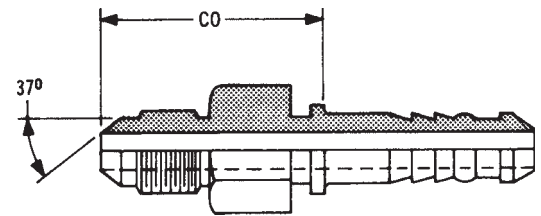

Part Number	Hose I.D.	Thread	Hex	Stem I.D.	Fitting Length	-CO-Cutoff
208-508	1/2	3/4 - 16	13/16	.390	2.378	1.218
208-510	1/2	7/8 - 14	7/8	.406	2.472	1.312
412-512	3/4	1-1/16 - 12	1-1/8	.625	3.398	1.543
412-516	3/4	1-5/16 - 12	1-3/8	.625	3.505	1.650
416-516	1	1-5/16 - 12	1-3/8	.844	3.726	1.676
220-520	1-1/4	1-5/8 - 12	1-3/4	1.062	3.932	1.993
224-524	1-1/2	1-7/8 - 12	2	1.312	4.598	2.620
232-532	2	2-1/2 - 12	2-5/8	1.655	5.802	2.635

NPTF SOLID MALE STEM STAINLESS STEEL TYPE 303

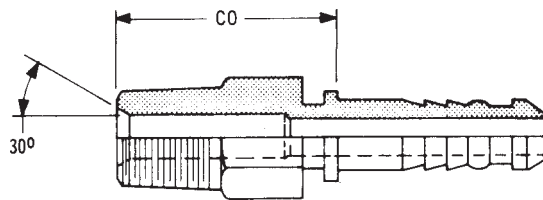

Part Number	Hose I.D.	Thread	Hex	Stem I.D.	Fitting Length	-CO-Cutoff
708-SS-108	1/2	1/2 - 14	7/8	.392	2.250	1.125
412-SS-112	3/4	3/4 - 14	1-1/16	.625	3.281	1.426
416-SS-116	1	1 - 11-1/2	1-3/8	.843	3.752	1.702
220-SS-120	1-1/4	1-1/4 - 11-1/2	1-3/4	1.062	3.943	2.020
224-SS-124	1-1/2	1-1/2 - 11-1/2	2	1.311	4.520	2.182
232-SS-132	2	2 - 11-1/2	2-1/2	1.655	5.500	2.324

JIC 37° SWIVEL FEMALE STEM

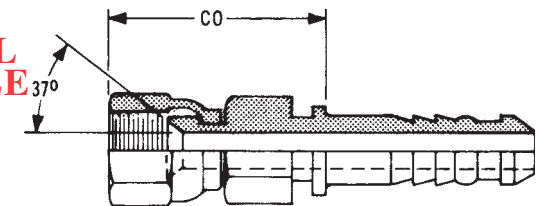

Part Number	Hose I.D.	Thread	Stem Hex	Nut Hex	Stem I.D.	Fitting Length	-CO-Cutoff
204-604	1/4	7/16 - 20	5/8	9/16	.156	1.995	1.070
204-605	1/4	1/2 - 20	5/8	11/16	.156	2.050	1.125
204-606	1/4	9/16 - 18	5/8	3/4	.156	2.035	1.120
206-606	3/8	9/16 - 18	11/16	3/4	.296	2.030	1.105
206-608	3/8	3/4 - 16	11/16	7/8	.296	2.165	1.245
208-608	1/2	3/4 - 16	13/16	7/8	.406	2.470	1.310
208-610	1/2	7/8 - 14	13/16	1-1/16	.406	2.300	1.370
412-610	3/4	7/8 - 14	1-1/16	1-1/16	.500	3.350	1.495
412-612	3/4	1-1/16 - 12	1-1/16	1-1/4	.625	3.400	1.552
412-XH-612	3/4	1-1/16 - 12	1-1/16	1-3/8	.625	3.400	1.552
412-614	3/4	1-3/16 - 12	1-1/16	1-3/8	.625	3.440	1.574
412-616	3/4	1-5/16 - 12	1-1/4	1-1/2	.625	3.538	1.670
416-612	1	1-1/16 - 12	1-3/8	1-1/4	.718	3.565	1.578
416-616	1	1-5/16 - 12	1-3/8	1-1/2	.844	3.746	1.692
416-XH-616	1	1-5/16 - 12	1-3/8	1-5/8	.844	3.666	1.612
220-620	1-1/4	1-5/8 - 12	1-3/4	2	1.062	4.155	2.195
224-624	1-1/2	1-7/8 - 12	2	2-1/4	1.312	4.800	2.415
232-632	2	2-1/2 - 12	2-5/8	2-7/8	1.655	6.075	2.930

NPTF SOLID MALE STEM STAINLESS STEEL TYPE 316

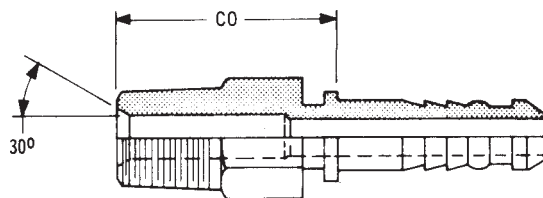

Part Number	Hose I.D.	Thread	Hex	Stem I.D.	Fitting Length	-CO-Cutoff
708-S16-108	1/2	1/2 - 14	7/8	.392	2.250	1.125
412-S16-112	3/4	3/4 - 14	1-1/16	.625	3.281	1.426
416-S16-116	1	1 - 11-1/2	1-3/8	.843	3.752	1.702
220-S16-120	1-1/4	1-1/4 - 11-1/2	1-3/4	1.062	3.943	2.020
224-S16-124	1-1/2	1-1/2 - 11-1/2	2	1.311	4.520	2.182
232-S16-132	2	2 - 11-1/2	2-1/2	1.655	5.500	2.324

JIC 37° SWIVEL FEMALE STEM STAINLESS STEEL TYPE 303

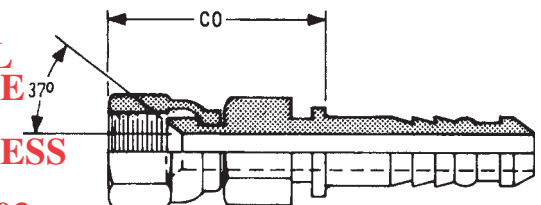

Part Number	Hose I.D.	Thread	Stem Hex	Nut Hex	Stem I.D.	Fitting Length	-CO-Cutoff
708-SS-608	1/2	3/4 - 16	13/16	7/8	.390	2.230	1.300
708-SS-610	1/2	7/8 - 14	13/16	1-1/16	.390	2.320	1.390
412-SS-612	3/4	1-1/16 - 12	1-1/16	1-1/4	.625	3.400	1.552
416-SS-616	1	1-5/16 - 12	1-3/8	1-1/2	.844	3.746	1.692
220-SS-620	1-1/4	1-5/8 - 12	1-3/4	2	1.062	4.155	2.195
224-SS-624	1-1/2	1-7/8 - 12	2	2-1/4	1.312	4.800	2.415
232-SS-632	2	2-1/2 - 12	2-5/8	2-7/8	1.655	6.075	2.930



Stems for SAE 100R12, Three Wire Braid & Spiral Hydraulic Hose

JIC 37° SWIVEL FEMALE STEM STAINLESS STEEL TYPE 316

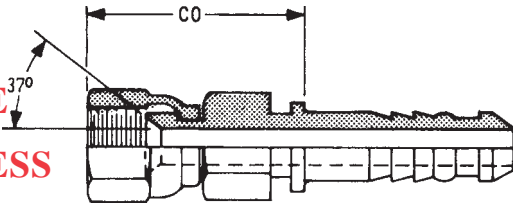

Part Number	Hose I.D.	Thread	Stem Hex	Nut Hex	Stem I.D.	Fitting Length	-CO-Cutoff
708-S16-608	1/2	3/4 - 16	13/16	7/8	.390	2.230	1.300
708-S16-610	1/2	7/8 - 14	13/16	1-1/16	.390	2.320	1.390
412-S16-612	3/4	1-1/16 - 12	1-1/16	1-1/4	.625	3.400	1.552
416-S16-616	1	1-5/16 - 12	1-3/8	1-1/2	.844	3.746	1.692
220-S16-620	1-1/4	1-5/8 - 12	1-3/4	2	1.062	4.155	2.195
224-S16-624	1-1/2	1-7/8 - 12	2	2-1/4	1.312	4.800	2.415
232-S16-632	2	2-1/2 - 12	2-5/8	2-7/8	1.655	6.075	2.930

ORB SOLID MALE STEM

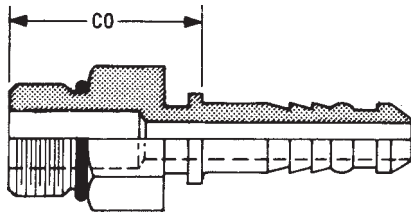

Part Number	Hose I.D.	Thread	Hex	Stem I.D.	Fitting Length	-CO-Cutoff
412-712	3/4	1-1/16 - 12	1-1/4	.625	3.125	1.270
416-716	1	1-5/16 - 12	1-1/2	.844	3.409	1.359
220-720	1-1/4	1-5/8 - 12	1-3/4	1.062	3.568	1.646

MALE "O"-LOK STEM

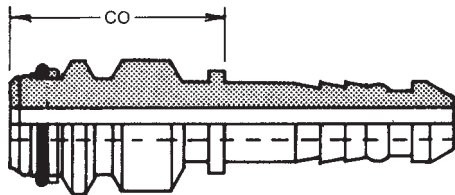

Part Number	Hose I.D.	Male Size	Stem I.D.	Fitting Length	-CO-Cutoff
204-S04	1/4	1/4	.156	2.227	.687
206-S06	3/8	3/8	.296	2.227	.687
208-S08	1/2	1/2	.406	2.477	.711
412-S12	3/4	3/4	.625	3.224	1.369
416-S16	1	1	.843	3.650	1.600
220-S20	1-1/4	1-1/4	1.062	3.683	1.764
224-S24	1-1/2	1-1/2	1.250	4.320	1.555
232-S32	2	2	1.655	5.160	2.035

TUBE STEM

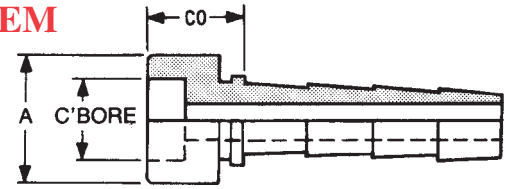

Part Number	Hose I.D.	C'Bore DIA	C'Bore Depth	-A-O.D.	Stem I.D.	Fitting Length	-CO-Cutoff
406-T06	3/8	3/8	.375	.750	.296	1.597	.687
408-T08	1/2	1/2	.375	.685	.406	1.847	.687
408-T10	1/2	5/8	.375	.685	.406	1.847	.687
412-T12	3/4	3/4	.375	.935	.625	2.566	.711
412-T16	3/4	1	.375	1.187	.625	2.579	.724
416-T16	1	1	.375	1.187	.844	2.800	.750
416-T20	1	1-1/4	.375	1.437	.844	2.800	.750
420-T20	1-1/4	1-1/4	.375	1.437	1.062	2.840	1.920
420-T24	1-1/4	1-1/2	.375	1.750	1.062	2.840	1.920
424-T24	1-1/2	1-1/2	.375	1.812	1.250	3.258	2.338
424-T32	1-1/2	2	.375	2.250	1.250	3.258	2.338
432-T32	2	2	.375	2.250	1.655	4.086	3.167

JIC 37° SWIVEL FEMALE STEM 45° BENT TUBE MEDIUM DROP

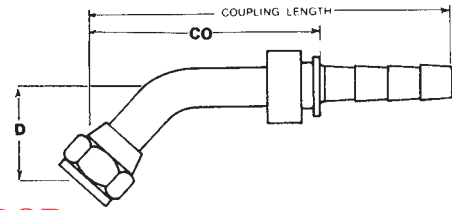

Part Number	Hose I.D.	Thread	Nut Hex	-D-Drop	Fitting Length	-CO-Cutoff
412-M-692	3/4	1-1/16 - 12	1-1/4	1.060	4.720	2.870
416-M-696	1	1-5/16 - 12	1-1/2	1.187	5.345	3.295
420-M-698	1-1/4	1-5/8 - 12	2	1.300	6.840	4.921

JIC 37° SWIVEL FEMALE STEM 90° BENT TUBE SHORT DROP

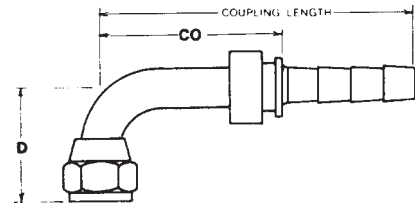

Part Number	Hose I.D.	Thread	Nut Hex	-D-Drop	Fitting Length	-CO-Cutoff
412-S-672	3/4	1-1/16 - 12	1-1/4	1.870	4.650	2.795
412-S-676	3/4	1-5/16 - 12	1-1/2	2.240	5.060	3.210
416-S-676	1	1-5/16 - 12	1-1/2	2.250	5.800	3.750
420-S-678	1-1/4	1-5/8 - 12	2	2.500	6.840	4.921

Stems for SAE 100R12, Three Wire Braid & Spiral Hydraulic Hose



**JIC 37°
SWIVEL
FEMALE
STEM
90° BENT
TUBE
MEDIUM
DROP**

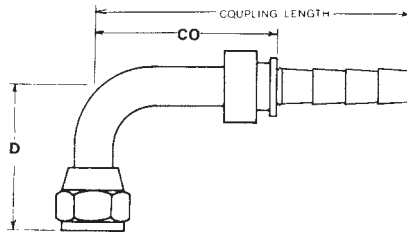

Part Number	Hose I.D.	Thread	Nut Hex	-D-Drop	Fitting Length	-CO-Cutoff
412-M-672	3/4	1-1/16 - 12	1-1/4	2.060	4.570	2.715
412-M-676	3/4	1-5/16 - 12	1-1/2	2.620	5.195	3.210
416-M-676	1	1-5/16 - 12	1-1/2	2.620	5.290	3.240
420-M-678	1-1/4	1-5/8 - 12	2	3.500	6.840	4.921

**JIC 37°
SWIVEL
FEMALE
STEM
90° BENT
TUBE
LONG
DROP**

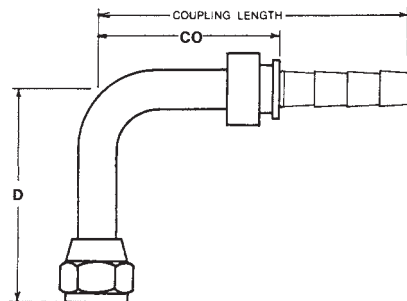

Part Number	Hose I.D.	Thread	Nut Hex	-D-Drop	Fitting Length	-CO-Cutoff
412-L-672	3/4	1-1/16 - 12	1-1/2	3.730	3.880	2.720
416-L-676	1	1-5/16 - 12	1-1/2	4.330	5.800	3.750

**"O" RING
FLANGE
HEAD
CODE 61**

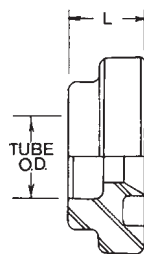

Part Number	Tube O.D.	Flange Size	Flange O.D.	Flange Length
408-F08	1/2	1/2	1-3/16	.500
408-F12	1/2	3/4	1-1/2	.500
412-F12	3/4	3/4	1-1/2	.500
412-F16	3/4	1	1-3/4	.562
414-F12	7/8	3/4	1-3/4	.500
416-F12	1	3/4	1-1/2	.500
416-F16	1	1	1-3/4	.562
416-F20	1	1-1/4	2	.562
420-F16	1-1/4	1	1-3/4	.562
420-F20	1-1/4	1-1/4	2	.562
420-F24	1-1/4	1-1/2	2-3/8	.625
420-F32	1-1/4	2	2-13/16	.625
424-F24	1-1/2	1-1/2	2-3/8	.625
424-F32	1-1/2	2	2-13/16	.625
432-F24	2	1-1/2	2-3/8	.625
432-F32	2	2	2-13/16	.625

**"O" RING
FLANGE
CODE 61
STRAIGHT**

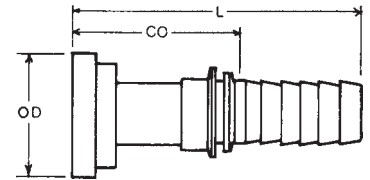

(Code 62 available on request)

Part Number	Hose I.D.	Flange Size	Flange O.D.	Fitting Length	-CO-Cutoff
408-G08	1/2	1/2	1-3/16	3.270	2.115
408-G12	1/2	3/4	1-1/2	3.400	2.245
412-G12	3/4	3/4	1-1/2	3.839	1.984
412-G16	3/4	1	1-3/4	3.901	2.046
416-G12	1	3/4	1-1/2	3.915	1.880
416-G16	1	1	1-3/4	4.150	2.100
416-G20	1	1-1/4	2	4.150	2.120
416-G32	1	2	2-13/16	4.268	2.218
420-G16	1-1/4	1	1-3/4	4.370	2.451
420-G20	1-1/4	1-1/4	2	4.370	2.447
420-G24	1-1/4	1-1/2	2-3/8	4.370	2.447
424-G24	1-1/2	1-1/2	2-3/8	4.788	2.450
424-G32	1-1/2	2	2-13/16	4.788	2.454
432-G24	2	1-1/2	2-3/8	5.786	2.602
432-G32	2	2	2-13/16	5.786	2.619

**"O" RING
FLANGE
CODE 61
22 1/2°**

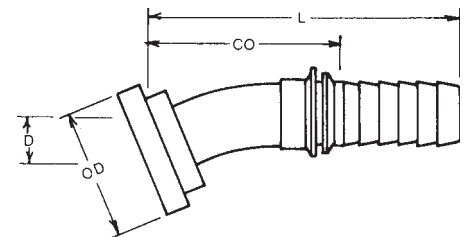

(Code 62 available on request)

Part Number	Hose I.D.	Flange Size	Flange O.D.	-D-Drop	Fitting Length	-CO-Cutoff
412-H02	3/4	3/4	1-1/2	.440	4.360	2.250
412-H03	3/4	1	1-3/4	.440	4.360	2.250
416-H03	1	1	1-3/4	.500	5.490	3.440
416-H04	1	1-1/4	2	.500	5.490	3.440
420-H04	1-1/4	1-1/4	2	.500	5.590	3.671
420-H05	1-1/4	1-1/2	2-3/8	.500	5.590	3.671
424-H05	1-1/2	1-1/2	2-3/8	.630	6.258	3.924
424-H06	1-1/2	2	2-13/16	.630	6.258	3.924
432-H06	2	2	2-13/16	.880	8.586	5.402



Stems for SAE 100R12, Three Wire Braid & Spiral Hydraulic Hose

**“O” RING
FLANGE
CODE 61
30°**

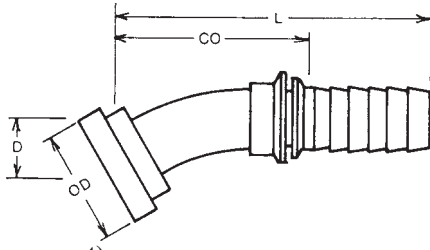

(Code 62 available on request)

Part Number	Hose I.D.	Flange Size	Flange O.D.	-D-Drop	Fitting Length	-CO-Cutoff
408-H21	1/2	1/2	1-3/16	.500	3.460	2.230
408-H22	1/2	3/4	1-1/2	.500	3.460	2.230
412-H22	3/4	3/4	1-1/2	.580	4.450	2.600
412-H23	3/4	1	1-3/4	.580	4.450	2.600
416-H23	1	1	1-3/4	.620	5.490	3.440
416-H24	1	1-1/4	2	.620	5.490	3.440
420-H24	1-1/4	1-1/4	2	.720	5.594	3.671
420-H25	1-1/4	1-1/2	2-3/8	.720	6.751	4.828
424-H25	1-1/2	1-1/2	2-3/8	.880	6.508	4.174
424-H26	1-1/2	2	2-13/16	.880	6.508	4.174
432-H26	2	2	2-13/16	1.250	9.086	5.902

**“O” RING
FLANGE
CODE 61
67 1/2°**

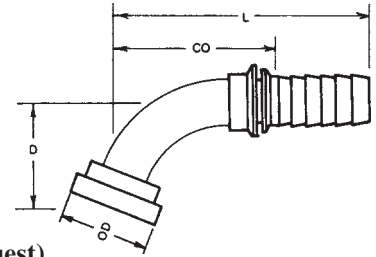

(Code 62 available on request)

Part Number	Hose I.D.	Flange Size	Flange O.D.	-D-Drop	Fitting Length	-CO-Cutoff
408-H61	1/2	1/2	1-3/16	1.350	3.450	2.300
408-H62	1/2	3/4	1-1/2	1.500	3.655	2.505
412-H62	3/4	3/4	1-1/2	1.750	5.550	3.700
412-H63	3/4	1	1-3/4	1.750	5.550	3.700
416-H63	1	1	1-3/4	1.800	5.800	3.750
416-H64	1	1-1/4	2	1.800	5.800	3.750
420-H64	1-1/4	1-1/4	2	1.930	6.090	4.167
420-H65	1-1/4	1-1/2	2-3/8	1.930	6.090	4.170
424-H65	1-1/2	1-1/2	2-3/8	2.080	7.000	4.674
432-H66	2	2	2-13/16	4.000	10.850	7.700

**“O” RING
FLANGE
CODE 61
45°**

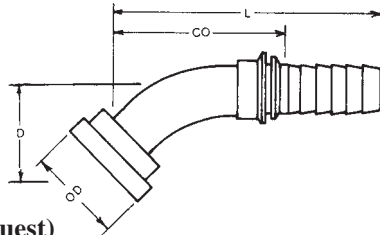

(Code 62 available on request)

Part Number	Hose I.D.	Flange Size	Flange O.D.	-D-Drop	Fitting Length	-CO-Cutoff
408-G41	1/2	1/2	1-3/16	.780	3.390	2.230
408-G42	1/2	3/4	1-1/2	.780	3.390	2.230
412-G42	3/4	3/4	1-1/2	1.000	4.635	2.780
412-G46	3/4	1	1-3/4	1.000	4.635	2.780
416-G46	1	1	1-3/4	1.060	5.600	3.550
416-G50	1	1-1/4	2	1.060	5.600	3.550
416-G62	1	2	2-13/16	1.060	5.600	3.550
420-G46	1-1/4	1	1-3/4	1.150	5.720	3.801
420-G50	1-1/4	1-1/4	2	1.150	5.720	3.797
420-G54	1-1/4	1-1/2	2-3/8	1.150	5.720	3.797
420-G62	1-1/4	2	2-13/16	1.150	5.720	3.801
424-G54	1-1/2	1-1/2	2-3/8	1.410	6.508	4.174
424-G62	1-1/2	2	2-13/16	1.410	6.508	4.174
432-G62	2	2	2-13/16	3.430	11.000	7.833

**“O” RING
FLANGE
CODE 61
90°**

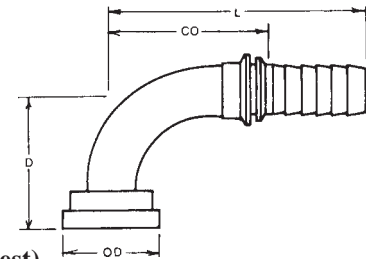

(Code 62 available on request)

Part Number	Hose I.D.	Flange Size	Flange O.D.	-D-Drop	Fitting Length	-CO-Cutoff
408-G71	1/2	1/2	1-3/16	1.630	3.170	2.110
408-G72	1/2	3/4	1-1/2	1.630	3.170	2.110
412-G72	3/4	3/4	1-1/2	2.130	4.440	2.580
412-G76	3/4	1	1-3/4	2.130	4.440	3.000
416-G76	1	1	1-3/4	2.380	5.300	3.250
416-G80	1	1-1/4	2	2.380	5.300	3.250
416-G92	1	2	2-13/16	3.880	5.300	3.250
420-G80	1-1/4	1-1/4	2	2.690	5.840	3.917
420-L-G80	1-1/4	1-1/4	2	3.880	5.840	3.917
420-G84	1-1/4	1-1/2	2-3/8	3.880	5.840	3.917
420-G92	1-1/4	2	2-13/16	3.880	5.840	3.917
424-G84	1-1/2	1-1/2	2-3/8	3.120	6.758	4.424
424-L-G84	1-1/2	1-1/2	2-3/8	4.750	6.762	4.424
424-G92	1-1/2	2	2-13/16	4.750	6.758	4.420
432-G92	2	2	2-13/16	4.500	9.586	6.419
432-L-G92	2	2	2-13/16	6.590	9.586	6.419

**“O” RING
FLANGE
CODE 61
60°**

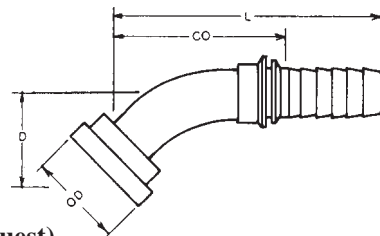

(Code 62 available on request)

Part Number	Hose I.D.	Flange Size	Flange O.D.	-D-Drop	Fitting Length	-CO-Cutoff
408-H51	1/2	1/2	1-3/16	-	-	-
412-H52	3/4	3/4	1-1/2	1.450	4.820	2.970
416-H53	1	1	1-3/4	1.900	5.550	3.500
420-H54	1-1/4	1-1/4	2	2.000	6.550	4.650
424-H55	1-1/2	1-1/2	2-3/8	3.380	7.190	4.852
432-H56	2	2	2-13/16	4.607	10.746	7.573

**“O” RING
FLANGE
CODE 61
110°**

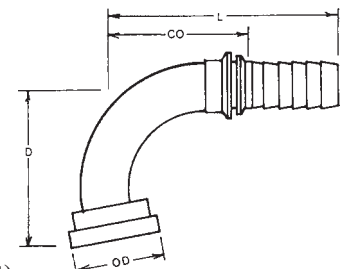

(Code 62 available on request)

Part Number	Hose I.D.	Flange Size	Flange O.D.	-D-Drop	Fitting Length	-CO-Cutoff
416-H83	1	1	1-3/4	2.820	3.580	2.450

Stems for SAE 100R12, Three Wire Braid & Spiral Hydraulic Hose



“O” RING FLANGE HEAD CODE 62

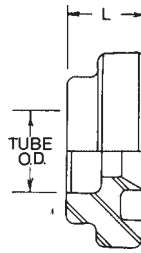

Part Number	Tube O.D.	Flange Size	Flange O.D.	Flange Length
408-62-F08	1/2	1/2	1-1/4	.562
412-62-F12	3/4	3/4	1-5/8	.687
416-62-F16	1	1	1-7/8	.812
420-62-F20	1-1/4	1-1/4	2-1/8	1.000
424-62-F24	1-1/2	1-1/2	2-1/2	1.187
432-62-F32	2	2	3-1/8	1.500

“O” RING FLANGE CODE 62 30°

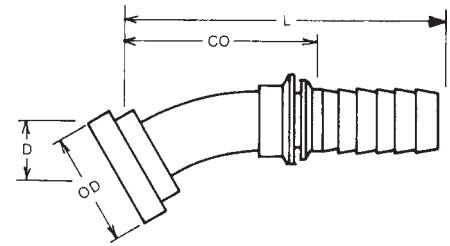

Part Number	Hose I.D.	Flange Size	Flange O.D.	-D-Drop	Fitting Length	-CO-Cutoff
424-62-H25	1-1/2	1-1/2	2-1/2	1.067	6.695	4.361

“O” RING FLANGE CODE 62 STRAIGHT

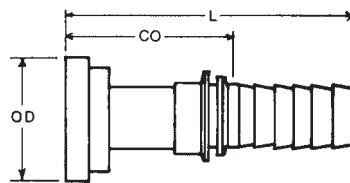

Part Number	Hose I.D.	Flange Size	Flange O.D.	Fitting Length	-CO-Cutoff
408-62-G08	1/2	1/2	1-1/4	3.332	2.177
412-62-G12	3/4	3/4	1-5/8	4.032	2.171
412-62-G16	3/4	1	1-7/8	4.180	2.330
416-62-G16	1	1	1-7/8	4.400	2.370
416-62-G20	1	1-1/4	2-1/8	4.587	2.557
420-62-G20	1-1/4	1-1/4	2-1/8	4.558	2.635
420-62-G24	1-1/4	1-1/2	2-1/2	4.932	3.013
424-62-G24	1-1/2	1-1/2	2-1/2	5.350	3.016

“O” RING FLANGE CODE 62 45°

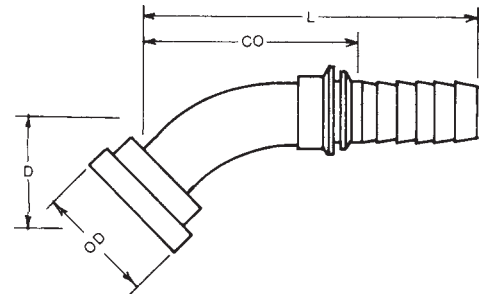

Part Number	Hose I.D.	Flange Size	Flange O.D.	-D-Drop	Fitting Length	-CO-Cutoff
412-62-G42	3/4	3/4	1-5/8	1.093	4.733	2.873
412-62-G46	3/4	1	1-7/8	1.125	4.765	2.905
416-62-G46	1	1	1-7/8	1.185	5.725	3.675
416-62-G50	1	1-1/4	2-1/8	1.278	5.818	3.768
420-62-G50	1-1/4	1-1/4	2-1/8	1.368	5.937	4.019
420-62-G54	1-1/4	1-1/2	2-1/2	1.431	6.000	4.082
424-62-G54	1-1/2	1-1/2	2-1/2	1.628	6.790	4.455

“O” RING FLANGE CODE 62 22 1/2°

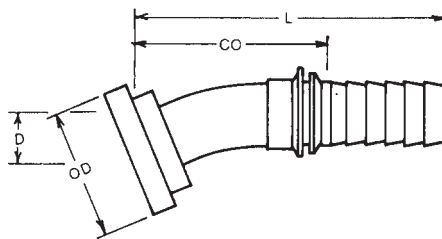

Part Number	Hose I.D.	Flange Size	Flange O.D.	-D-Drop	Fitting Length	-CO-Cutoff
424-62-H05	1-1/2	1-1/2	2-1/2	.771	6.399	4.065

“O” RING FLANGE CODE 62 90°

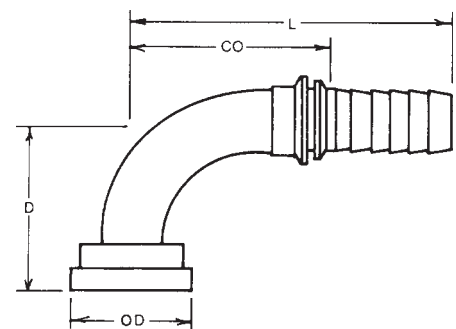

Part Number	Hose I.D.	Flange Size	Flange O.D.	-D-Drop	Fitting Length	-CO-Cutoff
412-62-G72	3/4	3/4	1-5/8	2.317	4.440	2.630
412-62-G76	3/4	1	1-7/8	2.380	4.440	2.585
416-62-G76	1	1	1-7/8	2.630	5.300	3.250
416-62-G80	1	1-1/4	2-1/8	2.817	5.300	3.250
420-62-G80	1-1/4	1-1/4	2-1/8	3.127	5.840	3.921
420-62-G84	1-1/4	1-1/2	2-1/2	3.250	5.840	3.921
424-62-G84	1-1/2	1-1/2	2-1/2	3.682	6.758	4.424



Ferrules for SAE 100R13 Hydraulic Hose

**FERRULE
SKIVE
REQUIRED**

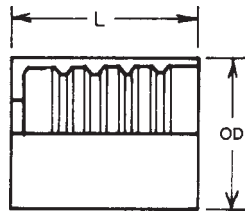

Part Number	Hose I.D.	-L-	-O.D.-	-I.D.-
608-600	1/2	1.500	1.215	.910
612-600	3/4	2.050	1.750	1.375
616-600	1	2.270	1.875	1.560
620-600	1-1/4	2.820	2.410	2.000
624-600	1-1/2	3.500	2.750	2.250
632-600	2	3.700	3.450	2.800

Stems for SAE 100R13 Hydraulic Hose



NPTF SOLID MALE STEM

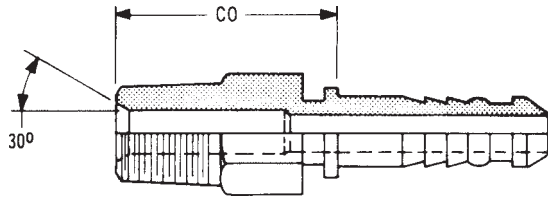

Part Number	Hose I.D.	Thread	Hex	Stem I.D.	Fitting Length	-CO-Cutoff
608-108	1/2	1/2 - 14				
612-112	3/4	3/4 - 14	1-1/8	.593	3.614	1.489
616-116	1	1 - 11-1/2	1-3/8	.812	4.167	1.917
620-120	1-1/4	1-1/4 - 11-1/2	1-3/4	1.062	4.833	2.083
624-124	1-1/2	1-1/2 - 11-1/2	2	1.250	5.500	2.250
632-132	2	2 - 11-1/2	2-1/2	1.625	5.906	2.281

"O" RING FLANGE-CODE 62 STRAIGHT

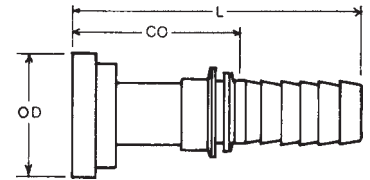

Part Number	Hose I.D.	Flange Size	Flange O.D.	Fitting Length	-CO-Cutoff
612-62-G12	3/4	3/4	1-5/8	4.555	2.430
612-62-G16	3/4	1	1-7/8	4.889	2.764
616-62-G16	1	1	1-7/8	5.130	2.880
616-62-G20	1	1-1/4	2-1/8	5.178	2.928
620-62-G20	1-1/4	1-1/4	2-1/8	5.750	3.000
620-62-G24	1-1/4	1-1/2	2-1/2	6.197	3.447
624-62-G24	1-1/2	1-1/2	2-1/2	6.770	3.520
624-62-G32	1-1/2	2	3-1/8	7.420	4.170
632-62-G32	2	2	3-1/8	7.795	4.170

JIC SWIVEL FEMALE STEM

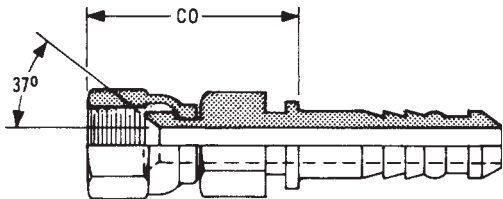

Part Number	Hose I.D.	Thread	Stem Hex	Nut Hex	Stem I.D.	Fitting Length	-CO-Cutoff
612-612	3/4	1-1/16 - 12	1-1/8	1-3/8	.593	3.680	1.550
616-616	1	1-5/16 - 12	1-3/8	1-1/2	.812	4.145	1.895
620-620	1-1/4	1-5/8 - 12	1-3/4	2	1.062	5.095	2.345
624-624	1-1/2	1-7/8 - 12	2	2-1/4	1.250	5.850	2.600
632-632	2	2-1/2 - 12	2-1/2	2-7/8	1.625	6.700	3.075

"O" RING FLANGE-CATERPILLAR-STRAIGHT

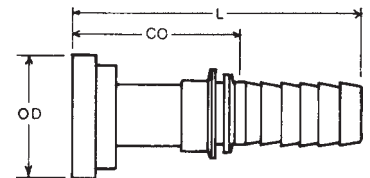

Part Number	Hose I.D.	Flange Size	Flange O.D.	Fitting Length	-CO-Cutoff
612-C-G12	3/4	3/4	1-5/8	5.264	3.139
612-C-G16	3/4	1	1-7/8	4.889	2.764
616-C-G16	1	1	1-7/8	5.130	2.880
616-C-G20	1	1-1/4	2-1/8	5.178	2.928
620-C-G20	1-1/4	1-1/4	2-1/8	5.750	3.000
620-C-G24	1-1/4	1-1/2	2-1/2	6.197	3.447
624-C-G24	1-1/2	1-1/2	2-1/2	6.880	3.630
624-C-G32	1-1/2	2	3-1/8	7.420	4.170
632-C-G32	2	2	3-1/8	7.805	4.180

"O" RING FLANGE-CODE 61 STRAIGHT

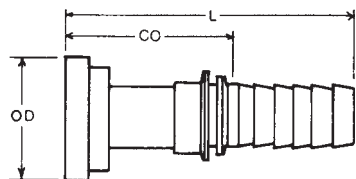

Part Number	Hose I.D.	Flange Size	Flange O.D.	Fitting Length	-CO-Cutoff
612-G12	3/4	3/4	1-1/2	4.555	2.430
616-G16	1	1	1-3/4	5.130	2.880
620-G20	1-1/4	1-1/4	2	5.750	3.000
624-G24	1-1/2	1-1/2	2-3/8	6.770	3.520
632-G32	2	2	2-13/16	7.805	4.180



One-Piece 1W SAE 100R12 Non-Skive Fittings SAE 100R13 Skive

NPTF SOLID MALE STEM

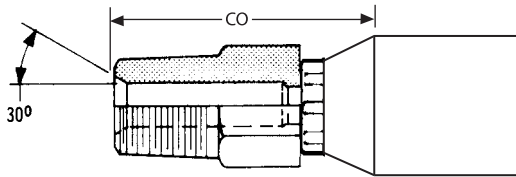

Part Number	Hose I.D.	Thread	Hex	Stem I.D.	Fitting Length	-CO-Cutoff
608-1W-108	1/2	1/2 - 14	7/8	.39	2.83	1.37
612-1W-112	3/4	3/4 - 14	1-1/16	.58	3.17	1.47
612-1W-116	3/4	1 - 11-1/2	1-3/8	.58	3.36	1.66
616-1W-116	1	1 - 11-1/2	1-3/8	.78	3.67	1.72
620-1W-120	1-1/4	1-1/4 11-1/2	1-3/4	1.01	4.29	1.91
624-1W-124	1-1/2	1-1/2 11-1/2	2	1.25	4.91	2.03
632-1W-132	2	2 11-1/2	2-1/2	1.61	5.28	2.23

JIC 37° SWIVEL FEMALE STEM

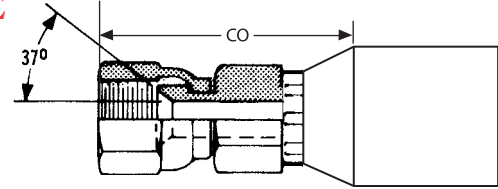

Part Number	Hose I.D.	Thread	Stem Hex	Nut Hex	Stem I.D.	Fitting Length	-CO-Cutoff
608-1W-608	1/2	3/4 - 16	13/16	7/8	.39	1.83	1.40
608-1W-610	1/2	7/8 - 14	13/16	1-1/16	.39	2.93	1.50
612-1W-610	3/4	7/8 - 14	1-1/16	1-1/16	.58	3.23	1.53
612-1W-612	3/4	1-1/16 - 12	1-1/16	1-3/8	.58	3.27	1.58
612-1W-614	3/4	1-3/16 - 12	1-1/16	1-3/8	.58	3.26	1.56
612-1W-616	3/4	1-5/16 - 12	1-1/4	1-5/8	.58	3.47	1.77
616-1W-616	1	1-5/16 - 12	1-3/8	1-5/8	.78	3.77	1.82
616-1W-620	1	1-5/8 - 12	1-1/2	2	.78	3.89	1.94
620-1W-620	1-1/4	1-5/8 - 12	1-3/4	2	1.01	4.64	2.24
620-1W-624	1-1/4	1-7/8 - 12	2	2-1/4	1.01		
624-1W-624	1-1/2	1-7/8 - 12	2	2-1/4	1.25	5.28	2.40
632-1W-632	2	2-1/2 - 12	2-1/2	2-7/8	1.61	5.94	2.89

NPTF SWIVEL MALE

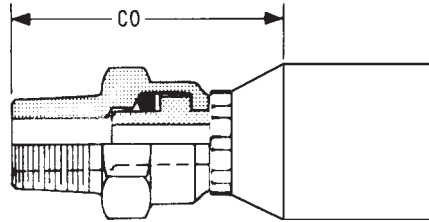

Part Number	Hose I.D.	Thread	Nut Hex	Stem I.D.	Fitting Length	-CO-Cutoff
608-1W-208	1/2	1/2 - 14	7/8	.39		
612-1W-212	3/4	3/4 - 14	1-5/16	.58	3.57	1.87

ORB SOLID MALE STEM

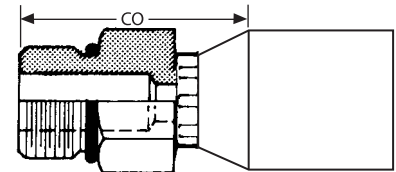

Part Number	Hose I.D.	Thread	Hex	Stem I.D.	Fitting Length	-CO-Cutoff
612-1W-712	3/4	1-1/16 - 12	1-1/4	.58	2.95	1.25
616-1W-716	1	1-5/16 - 12	1-1/2	.78	3.27	1.32
620-1W-720	1-1/4	1-5/8 - 12	1-3/4	1.01	3.91	1.54

JIC 37° SOLID MALE STEM

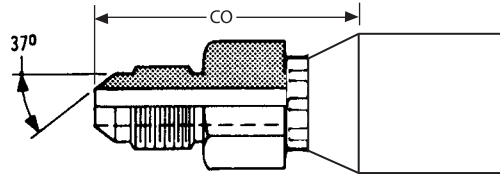

Part Number	Hose I.D.	Thread	Hex	Stem I.D.	Fitting Length	-CO-Cutoff
608-1W-508	1/2	3/4 - 16	13/16	.39	2.67	1.22
608-1W-510	1/2	7/8 - 14	7/8	.39	2.76	1.31
612-1W-512	3/4	1-1/16 - 12	1-1/8	.58	3.22	1.52
612-1W-516	3/4	1-5/16 - 12	1-3/8	.58	3.27	1.57
616-1W-516	1	1-5/16 - 12	1-3/8	.78	3.65	1.70
620-1W-520	1-1/4	1-5/8 - 12	1-3/4	1.01	4.28	1.90
620-1W-524	1-1/4	1-7/8 - 12	2	1.01	4.53	2.15
624-1W-524	1-1/2	1-7/8 - 12	2	1.25	4.99	2.12
632-1W-532	2	2-1/2 - 12	2-5/8	1.61	5.58	2.53

MALE "O"-LOK STEM

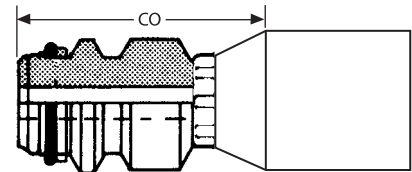

Part Number	Hose I.D.	Male Size	Stem I.D.	Fitting Length	-CO-Cutoff
608-1W-S08	1/2	1/2	.39	2.77	1.31
612-1W-S12	3/4	3/4			
616-1W-S16	1	1			
620-1W-S20	1-1/4	1-1/4			
624-1W-S24	1-1/2	1-1/2			
632-1W-S32	2	2			

One-Piece **1W** SAE 100R12 Non-Skive Fittings SAE 100R13 Skive



JIC 37° SWIVEL FEMALE STEM 45° BENT TUBE MEDIUM DROP

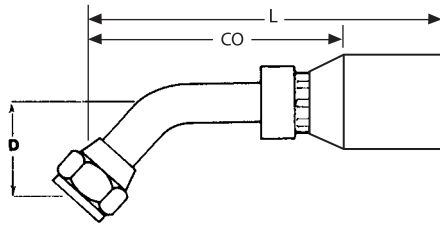

Part Number	Hose I.D.	Thread	Nut Hex	-D-Drop	Fitting Length	-CO-Cutoff
608-1WBS-688	1/2	3/4 - 16	7/8	.55	3.88	2.43
608-1WBS-690	1/2	7/8 - 14	1	.65	4.17	2.72
612-1WM-692	3/4	1-1/16 - 12		.98	4.09	2.39
612-1WM-696	3/4	1-5/16 - 12		1.10	4.21	2.51
616-1WM-696	1	1-5/16 - 12		1.04	4.65	2.70
616-1WM-698	1	1-5/8 - 12		1.32	4.92	2.97
620-1WM-698	1-1/4	1-5/8 - 12		1.42	6.16	3.79
620-1WM-699	1-1/4	1-7/8 - 12		1.61	6.36	3.98
624-1WM-699	1-1/2	1-7/8 - 12		1.81	7.40	4.53
632-1WM-700	2	2-1/2 - 12		2.21	8.48	5.43

JIC 37° SWIVEL FEMALE STEM 90° BENT TUBE LONG DROP

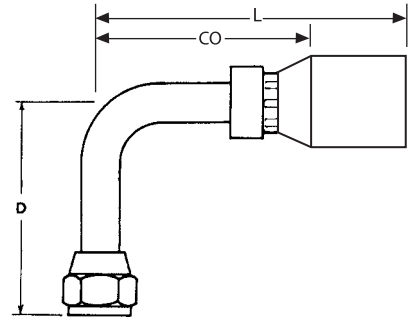

Part Number	Hose I.D.	Thread	Nut Hex	-D-Drop	Fitting Length	-CO-Cutoff
608-1WBL-668	1/2	3/4 - 16	7/8	2.43	3.40	1.95
612-1WL-672	3/4	1-1/16 - 12		3.74	3.82	2.12
616-1WL-676	1	1-5/16 - 12				

JIC 37° SWIVEL FEMALE STEM 90° BENT TUBE SHORT DROP

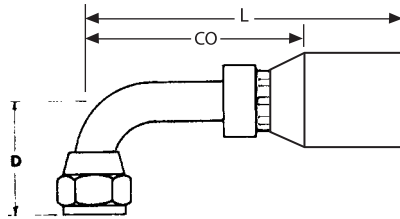

Part Number	Hose I.D.	Thread	Nut Hex	-D-Drop	Fitting Length	-CO-Cutoff
608-1WBS-668	1/2	3/4 - 16	7/8	1.17	3.34	1.88
608-1WBS-670	1/2	7/8 - 14	1	1.32	3.70	2.25
612-1WS-672	3/4	1-1/16 - 12				
612-1WS-676	3/4	1-5/16 - 12				
616-1WS-676	1	1-5/16 - 12				
616-1WS-678	1	1-5/8 - 12				
620-1WS-678	1-1/4	1-5/8 - 12				

SOLID MALE FLAT FACE "O" RING SEAL STEM

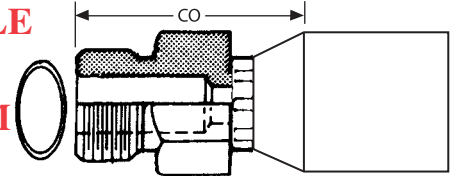

Part Number	Hose I.D.	Thread	Hex	Stem I.D.	Fitting Length	-CO-Cutoff	"O" Ring Part No.
608-1WFS-08	1/2	13/16 - 16	7/8	.39	2.52	1.06	8 ORFS
612-1WFS-12	3/4	1-3/16 - 12	1-1/4	.58	3.03	1.33	12 ORFS
616-1WFS-16	1	1-7/16 - 12	1-1/2				16 ORFS
620-1WFS-20	1-1/4	1-11/16 - 12	1-3/4				20 ORFS
624-1WFS-24	1-1/2	2 - 12	2-1/8				24 ORFS

JIC 37° SWIVEL FEMALE STEM 90° BENT TUBE MEDIUM DROP

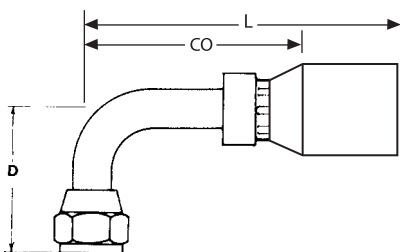

Part Number	Hose I.D.	Thread	Nut Hex	-D-Drop	Fitting Length	-CO-Cutoff
612-1WM-672	3/4	1-1/16 - 12		2.56	3.82	2.12
612-1WM-676	3/4	1-5/16 - 12		2.91	3.82	2.12
616-1WM-676	1	1-5/16 - 12		2.80	4.45	2.50
616-1WM-678	1	1-5/8 - 12		3.19	4.45	2.50
620-1WM-678	1-1/4	1-5/8 - 12		3.15	5.91	3.53
620-1WM-680	1-1/4	1-7/8 - 12		3.54	5.91	3.53
624-1WM-680	1-1/2	1-7/8 - 12		3.94	6.85	3.98
632-1WM-684	2	2-1/2 - 12		4.88	8.03	4.98

SWIVEL FEMALE FLAT FACE "O" RING SEAL STEM STRAIGHT

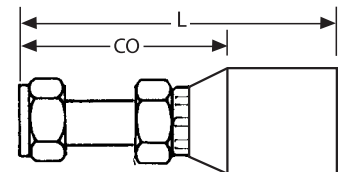

Part Number	Hose I.D.	Thread	Stem Hex	Nut Hex	Fitting Length	-CO-Cutoff
608-1WFSX-06	1/2	11/16 - 16	13/16		2.36	.91
608-1WFSX-08	1/2	13/16 - 16	13/16		2.40	.95
608-1WFSX-10	1/2	1 - 14	7/8		2.42	.97
608-1WFSX-12	1/2	1-3/16 - 12	1-1/8		2.43	.98
612-1WFSX-08	3/4	13/16 - 16	1			
612-1WFSX-10	3/4	1 - 14	1		2.70	1.00
612-1WFSX-12	3/4	1-3/16 - 12				
612-1WFSX-16	3/4	1-7/16 - 12		1-5/8	3.11	1.41
616-1WFSX-16	1	1-7/16 - 12		1-5/8	3.39	1.44
616-1WFSX-20	1	1-11/16 - 12		1-31/32	3.43	1.48
620-1WFSX-20	1-1/4	1-11/16 - 12		1-31/32	3.94	1.56
624-1WFSX-24	1-1/2	2 - 12		2-1/4	4.33	1.46

(B designates braze)



One-Piece 1W SAE 100R12 Non-Skive Fittings SAE 100R13 Skive

SWIVEL FEMALE FLAT FACE "O" RING SEAL STEM 45°

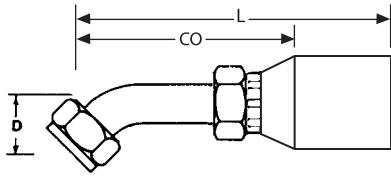

Part Number	Hose I.D.	Thread	Nut Hex	-D-Drop	Fitting Length	-CO-Cutoff
608-1WFSX-L68	1/2	13/16 - 16				
612-1WFSX-L72	3/4	1-3/16 - 12	36MM	.87	3.40	2.30
612-1WFSX-L76	3/4	1-7/16 - 12	1-5/8	.91	4.04	2.34
616-1WFSX-L76	1	1-7/16 - 12	1-5/8	1.16	4.61	2.66
620-1WFSX-L80	1-1/4	1-11/16 - 12	1-31/32	1.14	5.91	3.53
624-1WFSX-L84	1-1/2	2 - 12	2-1/4	1.58	7.19	4.31

SWIVEL FEMALE FLAT FACE "O" RING SEAL STEM 90° LONG DROP

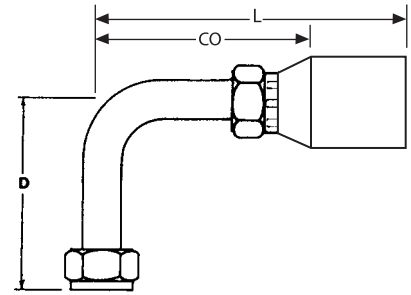

Part Number	Hose I.D.	Thread	Nut Hex	-D-Drop	Fitting Length	-CO-Cutoff
608-1WFSX-A68	1/2	13/16 - 16	1-1/16	2.52	3.11	1.66
612-1WFSX-A72	3/4	1-3/16 - 12	36MM	3.78	3.82	2.12
616-1WFSX-A76	1	1-7/16 - 12	1-5/8	4.49	4.45	2.50
620-1WFSX-A80	1-1/4	1-11/16 - 12	1-31/32	5.12	5.91	3.53

SWIVEL FEMALE FLAT FACE "O" RING SEAL STEM 90° SHORT DROP

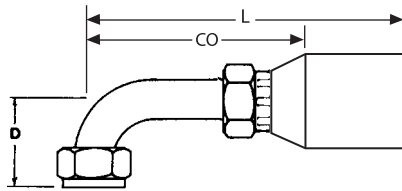

Part Number	Hose I.D.	Thread	Nut Hex	-D-Drop	Fitting Length	-CO-Cutoff
608-1WFSX-A28	1/2	13/16 - 16				
608-1WFSX-A30	1/2	1 - 14				
608-1WFSX-A32	1/2	1-3/16 - 12				
612-1WFSX-A32	3/4	1-3/16 - 12	36MM	1.93	3.82	2.12
612-1WFSX-A36	3/4	1-7/16 - 12	1-5/8	2.24	3.82	2.12
616-1WFSX-A36	1	1-7/16 - 12	1-5/8	2.46	4.45	2.50
620-1WFSX-A40	1-1/4	1-11/16 - 12				
624-1WFSX-A44	1-1/2	2 - 12				

"O" RING FLANGE CODE 61 STRAIGHT

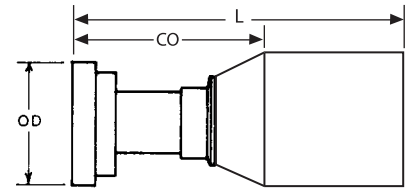

Part Number	Hose I.D.	Flange Size	Flange O.D.	Fitting Length	-CO-Cutoff
608-1WB-G08	1/2	1/2	1-3/16	3.56	2.11
608-1WB-G12	1/2	3/4	1-1/2	3.44	1.98
608-1W-G12	1/2	3/4	1-1/2	3.44	1.98
612-1WB-G12	3/4	3/4	1-1/2	3.68	1.98
612-1W-G12	3/4	3/4	1-1/2	3.68	1.98
612-1WB-G16	3/4	1	1-3/4	3.69	1.99
612-1W-G16	3/4	1	1-3/4	3.69	1.99
616-1W-G12	1	3/4	1-1/2	4.45	2.50
616-1W-G16	1	1	1-3/4	4.67	2.72
616-1W-G20	1	1-1/4	2	4.78	2.83
620-1W-G16	1-1/4	1	1-3/4	5.25	2.88
620-1W-G20	1-1/4	1-1/4	2	5.25	2.88
620-1W-G24	1-1/4	1-1/2	2-3/8	5.69	3.32
624-1W-G24	1-1/2	1-1/2	2-3/8	5.80	2.93
624-1W-G32	1-1/2	2	2-13/16	5.81	2.94
632-1W-G24	2	1-1/2	2-3/8		
632-1W-G32	2	2	2-13/16	6.90	3.85

SWIVEL FEMALE FLAT FACE "O" RING SEAL STEM 90° MEDIUM DROP

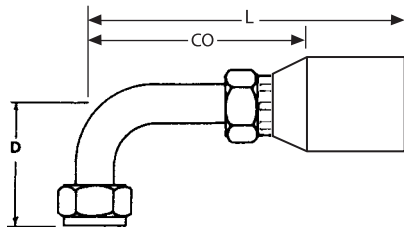

Part Number	Hose I.D.	Thread	Nut Hex	-D-Drop	Fitting Length	-CO-Cutoff
608-1WFSX-J38	1/2	13/16 - 16				
608-1WFSX-J40	1/2	1 - 14				
612-1WFSX-J42	3/4	1-3/16 - 12	36MM	2.40	3.82	2.12
616-1WFSX-J46	1	1-7/16 - 12	1-5/8	2.80	4.45	2.50
616-1WFSX-J50	1	1-11/16 - 12	1-31/32	3.07	4.89	2.94
620-1WFSX-J50	1-1/4	1-11/16 - 12	1-31/32	2.78	5.91	3.53
624-1WFSX-J54	1-1/2	2 - 12	2-1/4	3.48	6.85	3.98

"O" RING FLANGE CODE 61 22 1/2°

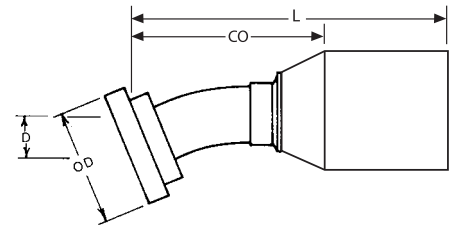

Part Number	Hose I.D.	Flange Size	Flange O.D.	-D-Drop	Fitting Length	-CO-Cutoff
612-1WB-H02	3/4	3/4	1-1/2	.44	4.36	2.66
612-1W-H02	3/4	3/4	1-1/2	.44	4.36	2.66
612-1WB-H03	3/4	1	1-3/4	.44	4.36	2.66
612-1W-H03	3/4	1	1-3/4	.44	4.36	2.66
616-1W-H03	1	1	1-3/4	.48	4.89	2.94
616-1W-H04	1	1-1/4	2	.49	4.98	3.03
620-1W-H04	1-1/4	1-1/4	2	.55	6.22	3.85
620-1W-H05	1-1/4	1-1/2	2-3/8	.75	6.67	4.30
624-1W-H05	1-1/2	1-1/2	2-3/8	.70	7.66	4.78
624-1W-H06	1-1/2	2	2-13/16			
632-1W-H06	2	2	2-13/16	.85	8.90	5.85

(B designates braze)

One-Piece **1W** SAE 100R12 Non-Skive Fittings SAE 100R13 Skive



**“O” RING
FLANGE
CODE 61
30°**

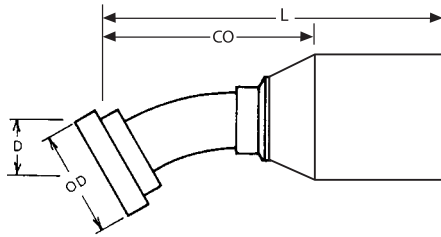

Part Number	Hose I.D.	Flange Size	Flange O.D.	-D-Drop	Fitting Length	-CO-Cutoff
608-1W-H21	1/2	1/2	1-3/16			
608-1W-H22	1/2	3/4	1-1/2			
612-1WB-H22	3/4	3/4	1-1/2	.58	4.45	2.75
612-1W-H22	3/4	3/4	1-1/2	.58	4.45	2.75
612-1WB-H23	3/4	1	1-3/4	.58	4.45	2.75
612-1W-H23	3/4	1	1-3/4	.58	4.45	2.75
616-1W-H23	1	1	1-3/4	.69	5.00	3.05
616-1W-H24	1	1-1/4	2	.71	5.18	3.23
620-1W-H24	1-1/4	1-1/4	2	.83	6.40	4.02
620-1W-H25	1-1/4	1-1/2	2-3/8	1.06	6.83	4.46
624-1W-H25	1-1/2	1-1/2	2-3/8	1.01	7.84	4.96
624-1W-H26	1-1/2	2	2-13/16			
632-1W-H26	2	2	2-13/16	1.24	9.15	6.10

**“O” RING
FLANGE
CODE 61
60°**

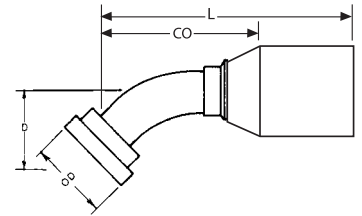

Part Number	Hose I.D.	Flange Size	Flange O.D.	-D-Drop	Fitting Length	-CO-Cutoff
608-1W-H51	1/2	1/2	1-3/16			
612-1WB-H52	3/4	3/4	1-1/2	1.45	4.82	3.12
612-1W-H52	3/4	3/4	1-1/2	1.45	4.82	3.12
612-1WB-H53	3/4	1	1-3/4	1.45	4.82	3.12
616-1W-H53	1	1	1-3/4	1.58	4.76	2.81
616-1W-H54	1	1-1/4	2	1.61	5.51	3.56
620-1W-H54	1-1/4	1-1/4	2	1.95	6.20	3.83
620-1W-H55	1-1/4	1-1/2	2-3/8	2.38	6.46	4.08
624-1W-H55	1-1/2	1-1/2	2-3/8	2.32	7.28	4.41
624-1W-H56	1-1/2	2	2-13/16			
632-1W-H56	2	2	2-13/16	2.95	8.47	5.42

**“O” RING
FLANGE
CODE 61
45°**

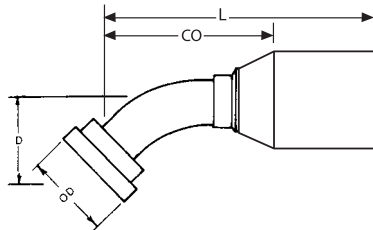

Part Number	Hose I.D.	Flange Size	Flange O.D.	-D-Drop	Fitting Length	-CO-Cutoff
608-1WB-G41	1/2	1/2	1-3/16	.78	3.68	2.23
608-1WB-G42	1/2	3/4	1-1/2	.78	3.68	2.23
612-1WB-G42	3/4	3/4	1-1/2	1.00	4.46	2.76
612-1W-G42	3/4	3/4	1-1/2	.97	4.09	2.39
612-1WB-G46	3/4	1	1-3/4	1.00	4.46	2.76
612-1W-G46	3/4	1	1-3/4	1.00	4.46	2.76
616-1W-G46	1	1	1-3/4	1.12	4.74	2.79
616-1W-G50	1	1-1/4	2	1.14	5.16	3.21
616-1W-G62	1	2	2-13/16			
620-1W-G46	1-1/4	1	1-3/4			
620-1W-G50	1-1/4	1-1/4	2	1.17	6.30	3.92
620-1W-G54	1-1/4	1-1/2	2-3/8	1.71	6.48	4.10
620-1W-G62	1-1/4	2	2-13/16			
624-1W-G54	1-1/2	1-1/2	2-3/8	1.65	7.24	4.37
624-1W-G62	1-1/2	2	2-13/16			
632-1W-G54	2	1-1/2	2-3/8			
632-1W-G62	2	2	2-13/16	2.07	8.35	5.30

**“O” RING
FLANGE
CODE 61
67½°**

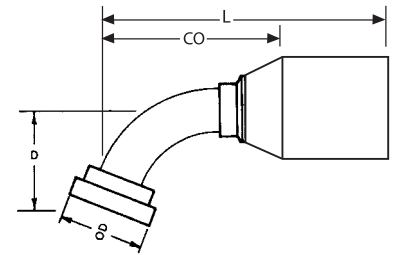

Part Number	Hose I.D.	Flange Size	Flange O.D.	-D-Drop	Fitting Length	-CO-Cutoff
608-1W-H61	1/2	1/2	1-3/16			
608-1W-H62	1/2	3/4	1-1/2			
612-1WB-H62	3/4	3/4	1-1/2	1.75	5.00	3.30
612-1W-H62	3/4	3/4	1-1/2	1.75	5.00	3.30
612-1WB-H63	3/4	1	1-3/4	1.75	5.00	3.30
612-1W-H63	3/4	1	1-3/4	1.75	5.00	3.30
616-1W-H63	1	1	1-3/4	1.79	4.73	2.78
616-1W-H64	1	1-1/4	2	1.81	5.71	3.76
620-1W-H64	1-1/4	1-1/4	2	2.22	6.18	3.81
620-1W-H65	1-1/4	1-1/2	2-3/8	2.68	6.38	4.00
624-1W-H65	1-1/2	1-1/2	2-3/8	2.64	7.24	4.37
624-1W-H66	1-1/2	2	2-13/16			
632-1W-H66	2	2	2-13/16	3.37	8.45	5.40

(B designates braze)



One-Piece 1W SAE 100R12 Non-Skive Fittings SAE 100R13 Skive

“O” RING FLANGE CODE 61 90°

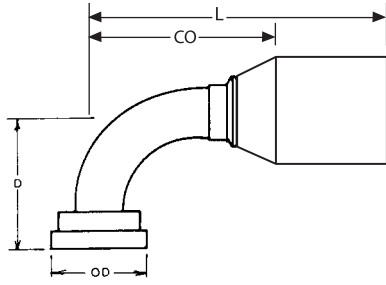

Part Number	Hose I.D.	Flange Size	Flange O.D.	-D-Drop	Fitting Length	-CO-Cutoff
608-1WB-G71	1/2	1/2	1-3/16	1.63	3.46	2.01
608-1WB-G72	1/2	3/4	1-1/2			
608-1W-G72	1/2	3/4	1-1/2			
612-1WB-G72	3/4	3/4	1-1/2	2.13	4.27	2.57
612-1W-G72	3/4	3/4	1-1/2	2.07	3.82	2.12
612-1WB-G76	3/4	1	1-3/4	2.13	4.27	2.57
616-1W-G76	1	1	1-3/4	2.76	4.45	2.50
616-1W-G80	1	1-1/4	2	3.54	4.45	2.50
616-1W-G92	1	2	2-13/16			
620-1W-G80	1-1/4	1-1/4	2	3.94	5.91	3.53
620-1W-G84	1-1/4	1-1/2	2-3/8	3.58	5.91	3.53
620-1W-G92	1-1/4	2	2-13/16			
624-1W-G84	1-1/2	1-1/2	2-3/8	5.79	6.85	3.98
624-1W-G92	1-1/2	2	2-13/16			
632-1W-G92	2	2	2-13/16	4.67	8.03	4.98

“O” RING FLANGE CODE 62 22 1/2°

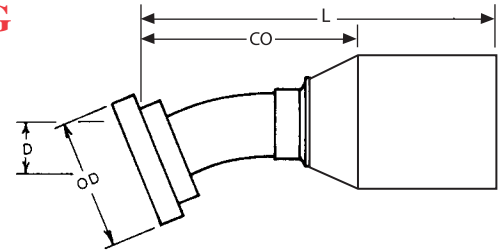

Part Number	Hose I.D.	Flange Size	Flange O.D.	-D-Drop	Fitting Length	-CO-Cutoff
612-1W62-H02	3/4	3/4	1-5/8			
612-1W62-H03	3/4	1	1-7/8			
616-1W62-H03	1	1	1-7/8	.59	5.18	3.23
616-1W62-H04	1	1-1/4	2-1/8			
620-1W62-H04	1-1/4	1-1/4	2-1/8			
620-1W62-H05	1-1/4	1-1/2	2-1/2			
624-1W62-H05	1-1/2	1-1/2	2-1/2			
624-1W62-H06	1-1/2	2	3-1/8			
632-1W62-H06	2	2	3-1/8			

“O” RING FLANGE CODE 61 110°

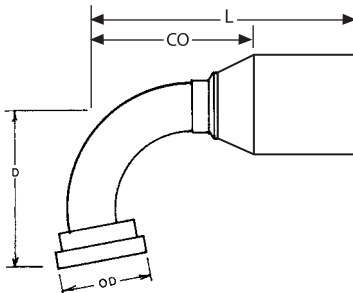

Part Number	Hose I.D.	Flange Size	Flange O.D.	-D-Drop	Fitting Length	-CO-Cutoff
616-1W-H83	1	1	1-3/4			

“O” RING FLANGE CODE 62 STRAIGHT

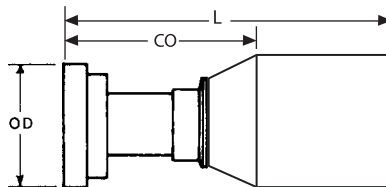

Part Number	Hose I.D.	Flange Size	Flange O.D.	Fitting Length	-CO-Cutoff
608-1W62-G08	1/2	1/2	1-1/4	3.17	1.72
612-1W62-G12	3/4	3/4	1-5/8	4.02	2.32
612-1W62-G16	3/4	1	1-7/8	4.02	2.32
616-1W62-G16	1	1	1-7/8	4.67	2.72
616-1W62-G20	1	1-1/4	2-1/8	4.97	3.02
620-1W62-G20	1-1/4	1-1/4	2-1/8	5.69	3.32
620-1W62-G24	1-1/4	1-1/2	2-1/2	5.69	3.32
624-1W62-G24	1-1/2	1-1/2	2-1/2	6.38	3.50
624-1W62-G32	1-1/2	2	3-1/8	6.69	3.81
632-1W62-G32	2	2	3-1/8	6.90	3.85

“O” RING FLANGE CODE 62 30°

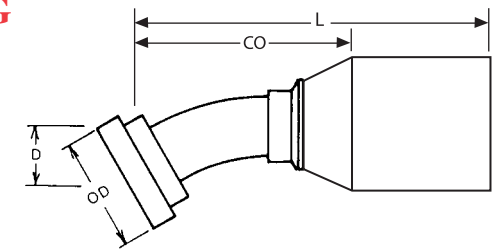

Part Number	Hose I.D.	Flange Size	Flange O.D.	-D-Drop	Fitting Length	-CO-Cutoff
612-1W62-H22	3/4	3/4	1-5/8			
612-1W62-H23	3/4	1	1-7/8			
616-1W62-H23	1	1	1-7/8	.85	5.28	3.33
616-1W62-H24	1	1-1/4	2-1/8			
620-1W62-H24	1-1/4	1-1/4	2-1/8	.94	6.65	4.28
620-1W62-H25	1-1/4	1-1/2	2-1/2			
624-1W62-H25	1-1/2	1-1/2	2-1/2	1.30	8.31	5.43
624-1W62-H26	1-1/2	2	3-1/8			
632-1W62-H26	2	2	3-1/8			

(B designates braze)

One-Piece **1W** SAE 100R12 Non-Skive Fittings SAE 100R13 Skive



**“O” RING
FLANGE
CODE 62
45°**

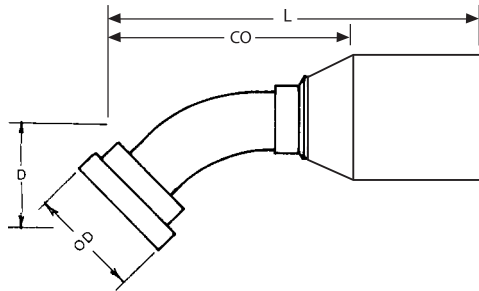

Part Number	Hose I.D.	Flange Size	Flange O.D.	-D-Drop	Fitting Length	-CO-Cutoff
608-1W62-G41	1/2	1/2	1-1/4			
608-1W62-G42	1/2	3/4	1-5/8			
612-1W62-G42	3/4	3/4	1-5/8	1.11	4.25	2.55
612-1W62-G46	3/4	1	1-7/8	1.33	4.45	2.75
616-1W62-G46	1	1	1-7/8	1.35	4.96	3.01
616-1W62-G50	1	1-1/4	2-1/8	1.46	5.07	3.12
620-1W62-G50	1-1/4	1-1/4	2-1/8	1.54	6.54	4.16
620-1W62-G54	1-1/4	1-1/2	2-1/2	1.84	6.97	4.59
624-1W62-G54	1-1/2	1-1/2	2-1/2	2.04	7.64	4.76
624-1W62-G62	1-1/2	2	3-1/8			
632-1W62-G62	2	2	3-1/8	2.32	8.60	5.55

**“O” RING
FLANGE
CODE 62
60°**

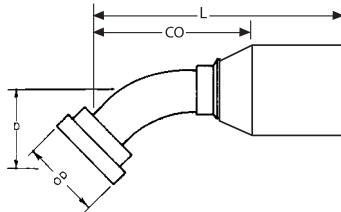

Part Number	Hose I.D.	Flange Size	Flange O.D.	-D-Drop	Fitting Length	-CO-Cutoff
612-1W62-H52	3/4	3/4	1-5/8			
612-1W62-H53	3/4	1	1-7/8			
616-1W62-H53	1	1	1-7/8			
616-1W62-H54	1	1-1/4	2-1/8			
620-1W62-H54	1-1/4	1-1/4	2-1/8	2.16	6.97	4.59
620-1W62-H55	1-1/4	1-1/2	2-1/2			
624-1W62-H55	1-1/2	1-1/2	2-1/2			
624-1W62-H56	1-1/2	2	3-1/8			
632-1W62-H56	2	2	3-1/8			

**“O” RING
FLANGE
CODE 62
67 1/2°**

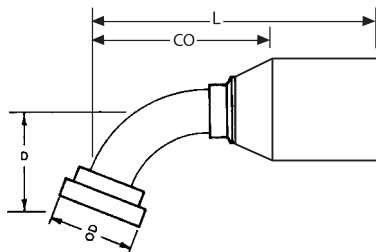

Part Number	Hose I.D.	Flange Size	Flange O.D.	-D-Drop	Fitting Length	-CO-Cutoff
612-1W62-H62	3/4	3/4	1-5/8			
612-1W62-H63	3/4	1	1-7/8			
616-1W62-H63	1	1	1-7/8			
616-1W62-H64	1	1-1/4	2-1/8			
620-1W62-H64	1-1/4	1-1/4	2-1/8			
620-1W62-H65	1-1/4	1-1/2	2-1/2			
624-1W62-H65	1-1/2	1-1/2	2-1/2			
624-1W62-H66	1-1/2	2	3-1/8			
632-1W62-H66	2	2	3-1/8			

**“O” RING
FLANGE
CODE 62
90°**

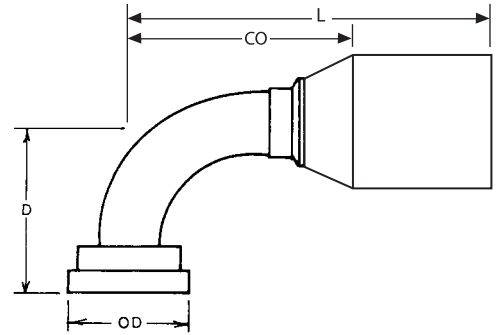

Part Number	Hose I.D.	Flange Size	Flange O.D.	-D-Drop	Fitting Length	-CO-Cutoff
608-1W62-G71	1/2	1/2	1-1/4			
608-1W62-G72	1/2	3/4	1-5/8			
612-1W62-G72	3/4	3/4	1-5/8	2.26	3.82	2.12
612-1W62-G76	3/4	1	1-7/8	2.56	3.82	2.12
616-1W62-G76	1	1	1-7/8	2.74	4.45	2.50
616-1W62-G80	1	1-1/4	2-1/8	2.89	4.45	2.50
620-1W62-G80	1-1/4	1-1/4	2-1/8	3.33	5.91	3.53
620-1W62-G84	1-1/4	1-1/2	2-1/2	3.76	5.91	3.53
624-1W62-G84	1-1/2	1-1/2	2-1/2	4.13	6.85	3.98
624-1W62-G92	1-1/2	2	3-1/8			
632-1W62-G92	2	2	3-1/8	5.04	8.03	4.98

**“O” RING
FLANGE
CATERPILLAR
STYLE
STRAIGHT**

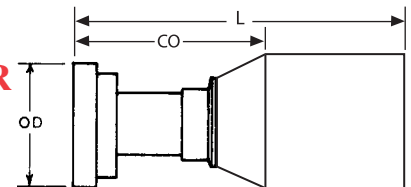

Part Number	Hose I.D.	Flange Size	Flange O.D.	Fitting Length	-CO-Cutoff
612-1WC-G12	3/4	3/4	1-5/8	4.33	2.63
612-1WC-G16	3/4	1	1-7/8	4.33	2.63
616-1WC-G16	1	1	1-7/8	4.42	2.47
616-1WC-G20	1	1-1/4	2-1/8	4.73	2.78
620-1WC-G20	1-1/4	1-1/4	2-1/8	5.69	3.32
620-1WC-G24	1-1/4	1-1/2	2-1/2	5.69	3.32
624-1WC-G24	1-1/2	1-1/2	2-1/2	6.19	3.31
624-1WC-G32	1-1/2	2	3-1/8	6.34	3.47
632-1WC-G32	2	2	3-1/8	6.55	3.50



One-Piece 1W SAE 100R12 Non-Skive Fittings

SAE 100R13 Skive

“O” RING FLANGE CATERPILLAR STYLE
22½°

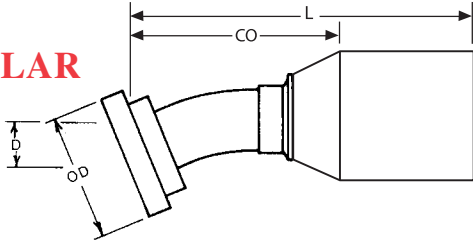

Part Number	Hose I.D.	Flange Size	Flange O.D.	-D-Drop	Fitting Length	-CO-Cutoff
612-1WC-H02	3/4	3/4	1-5/8	.59	4.76	3.06
612-1WC-H03	3/4	1	1-7/8	.63	4.86	3.16
616-1WC-H03	1	1	1-7/8	.94	5.44	3.49
616-1WC-H04	1	1-1/4	2-1/8	.72	5.46	3.51
620-1WC-H04	1-1/4	1-1/4	2-1/8	.65	5.32	2.94
620-1WC-H05	1-1/4	1-1/2	2-1/2			
624-1WC-H05	1-1/2	1-1/2	2-1/2	.94	8.23	5.35
624-1WC-H06	1-1/2	2	3-1/8			
632-1WC-H06	2	2	3-1/8	1.00	9.29	6.24

“O” RING FLANGE CATERPILLAR STYLE
60°

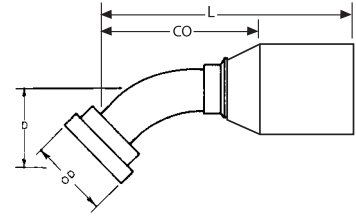

Part Number	Hose I.D.	Flange Size	Flange O.D.	-D-Drop	Fitting Length	-CO-Cutoff
612-1WC-H52	3/4	3/4	1-5/8	1.75	4.88	3.18
612-1WC-H53	3/4	1	1-7/8	1.85	4.84	3.14
616-1WC-H53	1	1	1-7/8	2.01	5.01	3.06
616-1WC-H54	1	1-1/4	2-1/8	2.12	5.08	3.13
620-1WC-H54	1-1/4	1-1/4	2-1/8	2.30	7.09	4.71
620-1WC-H55	1-1/4	1-1/2	2-1/2			
624-1WC-H55	1-1/2	1-1/2	2-1/2	2.87	7.60	4.72
624-1WC-H56	1-1/2	2	3-1/8			
632-1WC-H56	2	2	3-1/8	3.33	8.68	5.63

“O” RING FLANGE CATERPILLAR STYLE
30°

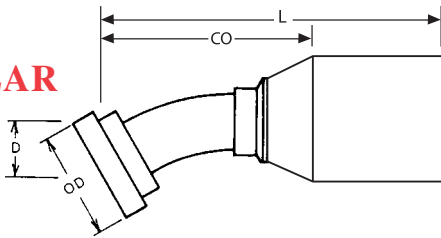

Part Number	Hose I.D.	Flange Size	Flange O.D.	-D-Drop	Fitting Length	-CO-Cutoff
612-1WC-H22	3/4	3/4	1-5/8	.83	4.82	3.12
612-1WC-H23	3/4	1	1-7/8	.89	4.88	3.18
616-1WC-H23	1	1	1-7/8	.94	5.44	3.49
616-1WC-H24	1	1-1/4	2-1/8	1.01	5.55	3.60
620-1WC-H24	1-1/4	1-1/4	2-1/8	1.02	6.81	4.44
620-1WC-H25	1-1/4	1-1/2	2-1/2			
624-1WC-H25	1-1/2	1-1/2	2-1/2	1.33	8.39	5.51
624-1WC-H26	1-1/2	2	3-1/8			
632-1WC-H26	2	2	3-1/8	1.46	9.55	6.50

“O” RING FLANGE CATERPILLAR STYLE
67½°

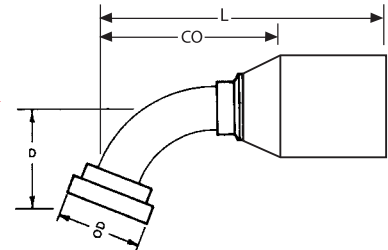

Part Number	Hose I.D.	Flange Size	Flange O.D.	-D-Drop	Fitting Length	-CO-Cutoff
612-1WC-H62	3/4	3/4	1-5/8	1.88	4.65	2.95
612-1WC-H63	3/4	1	1-7/8	1.98	4.76	3.06
616-1WC-H63	1	1	1-7/8	2.25	4.92	2.97
616-1WC-H64	1	1-1/4	2-1/8	2.37	4.97	3.02
620-1WC-H64	1-1/4	1-1/4	2-1/8			
620-1WC-H65	1-1/4	1-1/2	2-1/2			
624-1WC-H65	1-1/2	1-1/2	2-1/2			
624-1WC-H66	1-1/2	2	3-1/8			
632-1WC-H66	2	2	3-1/8	3.78	8.62	5.57

“O” RING FLANGE CATERPILLAR STYLE
45°

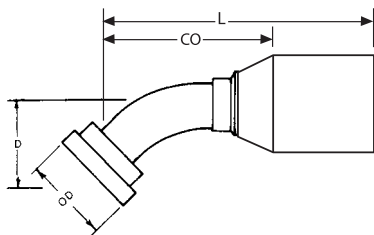

Part Number	Hose I.D.	Flange Size	Flange O.D.	-D-Drop	Fitting Length	-CO-Cutoff
612-1WC-G42	3/4	3/4	1-5/8	1.22	4.96	3.26
612-1WC-G46	3/4	1	1-7/8	1.38	4.84	3.14
616-1WC-G46	1	1	1-7/8	1.47	5.10	3.15
616-1WC-G50	1	1-1/4	2-1/8	1.57	5.19	3.24
620-1WC-G50	1-1/4	1-1/4	2-1/8	1.62	6.65	4.28
620-1WC-G54	1-1/4	1-1/2	2-1/2	1.89	6.65	4.28
624-1WC-G54	1-1/2	1-1/2	2-1/2	2.10	7.70	4.82
624-1WC-G62	1-1/2	2	3-1/8			
632-1WC-G62	2	2	3-1/8	2.38	8.64	5.59

“O” RING FLANGE CATERPILLAR STYLE
90°

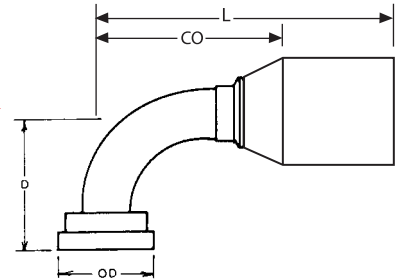

Part Number	Hose I.D.	Flange Size	Flange O.D.	-D-Drop	Fitting Length	-CO-Cutoff
612-1WC-G72	3/4	3/4	1-5/8	2.52	3.74	2.04
612-1WC-G76	3/4	1	1-7/8	2.64	3.74	2.04
616-1WC-G76	1	1	1-7/8	2.92	4.45	2.50
616-1WC-G80	1	1-1/4	2-1/8	3.05	4.45	2.50
620-1WC-G80	1-1/4	1-1/4	2-1/8	3.48	5.91	3.53
620-1WC-G84	1-1/4	1-1/2	2-1/2	3.82	5.91	3.53
624-1WC-G84	1-1/2	1-1/2	2-1/2	4.21	6.85	3.98
624-1WC-G92	1-1/2	2	3-1/8			
632-1WC-G92	2	2	3-1/8	5.11	8.03	4.98

One-Piece Metric Fittings

1W SAE 100R12 Non-Skive SAE 100R13 Skive



METRIC SWIVEL FEMALE W/ O-RING DIN LIGHT STRAIGHT

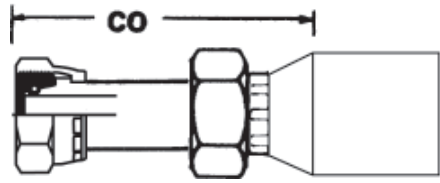

Part Number	Hose I.D.	Thread	DIN Tube O.D.(mm)	Fitting Length	-CO-Cutoff
612-1WDL-626	3/4	26MM x 1.5	18	2.78	1.08
612-1WDL-630	3/4	30MM x 2	22	2.84	1.14
616-1WDL-636	1	36MM x 2	28	3.19	1.24
620-1WDL-645	1-1/4	45MM x 2	35	3.84	1.46

METRIC SWIVEL FEMALE W/ O-RING & UNIV CONE SEAT DIN HEAVY STRAIGHT

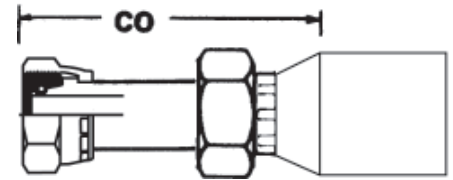

Part Number	Hose I.D.	Thread	DIN Tube O.D.(mm)	Fitting Length	-CO-Cutoff
612-1WDH-630	3/4	30MM x 2	20	3.07	1.37
612-1WDH-636	3/4	36MM x 2	25	3.15	1.45
616-1WDH-642	1	42MM x 2	30	3.54	1.59
620-1WDH-652	1-1/4	52MM x 2	38	4.15	1.78

METRIC SWIVEL FEMALE W/ O-RING DIN LIGHT 45°

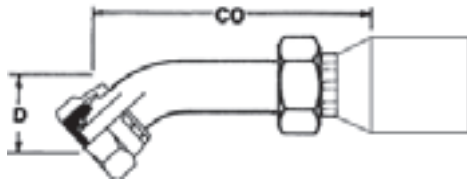

Part Number	Hose I.D.	Thread	DIN Tube O.D.(mm)	-D-Drop	Fitting Length	-CO-Cutoff
612-1WDL-630 45	3/4	30MM x 2	22	.97	4.10	2.40

METRIC SWIVEL FEMALE W/ O-RING & UNIV CONE SEAT DIN HEAVY 45°

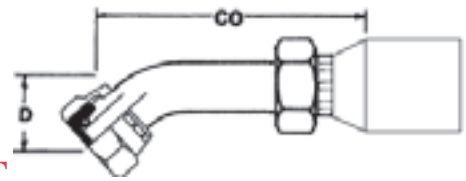

Part Number	Hose I.D.	Thread	DIN Tube O.D.(mm)	-D-Drop	Fitting Length	-CO-Cutoff
612-1WDH-636 45	3/4	36MM x 2	25	1.12	4.25	2.55
616-1WDH-642 45	1	42MM x 2	30	1.28	4.88	2.93
620-1WDH-652 45	1-1/4	52MM x 2	38	1.77	6.52	4.14

METRIC SWIVEL FEMALE W/ O-RING DIN LIGHT 90°

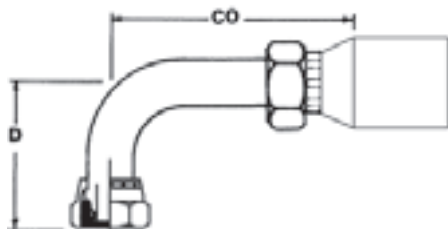

Part Number	Hose I.D.	Thread	DIN Tube O.D.(mm)	-D-Drop	Fitting Length	-CO-Cutoff
612-1WDL-630 90	3/4	30MM x 2	22	2.07	3.82	2.12
620-1WDL-645 90	1-1/4	45MM x 2	35	3.68	5.91	3.53

METRIC SWIVEL FEMALE W/ O-RING & UNIV CONE SEAT DIN HEAVY 90°

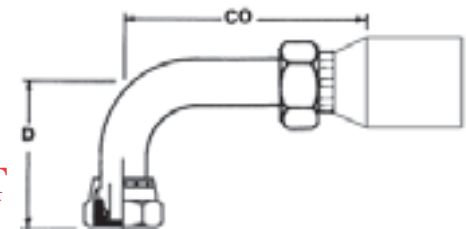

Part Number	Hose I.D.	Thread	DIN Tube O.D.(mm)	-D-Drop	Fitting Length	-CO-Cutoff
612-1WDH-636 90	3/4	36MM x 2	25	2.28	3.82	2.12
616-1WDH-642 90	1	42MM x 2	30	2.64	4.45	2.50
620-1WDH-652 90	1-1/4	52MM x 2	38	3.64	5.91	3.53



Ferrules for NRP A184, A096, A098 Spray & Washer Hose

**1 & 2 WIRE
COMBINATION
STEEL
FERRULE
SKIVE
REQUIRED**

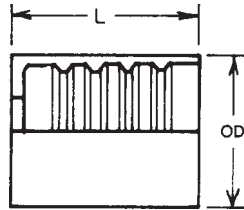

**1 & 2 WIRE
COMBINATION
STAINLESS STEEL
TYPE 303-304-316
FERRULE
SKIVE REQUIRED**

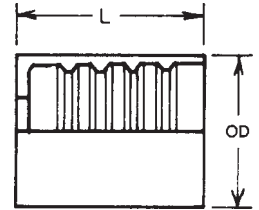

Part Number	Hose I.D.	-L-	-O.D.-	-I.D.-
204-200	1/4	1.000	.814	.628
206-200	3/8	1.000	.937	.755
208-200	1/2	1.250	1.125	.880
212-200	3/4	1.486	1.437	1.220

Part Number	Hose I.D.	-L-	-O.D.-	-I.D.-
204-SS-200	1/4	1.000	.814	.628
206-SS-200	3/8	1.000	.937	.755
208-SS-200	1/2	1.250	1.125	.880
212-SS-200	3/4	1.486	1.437	1.220

**1 & 2 WIRE
COMBINATION
NON-SKIVE
STEEL
FERRULE**

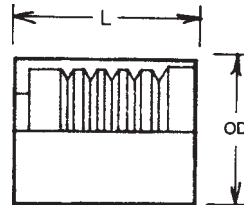

Part Number	Hose I.D.	-L-	-O.D.-	-I.D.-
504-500	1/4	1.000	.873	.630
506-500	3/8	1.000	1.060	.793
508-500	1/2	1.230	1.153	.905
512-500	3/4	1.470	1.531	1.211

Stems for NRP A184, A096, A098 Spray & Washer Hose Same As SAE 100R1 & 100R2

**USE OF
STEMS WITH
INTERNAL "O" RING
NOT RECOMMENDED**



Push-On Stems-Brass

NPTF SOLID MALE STEM BRASS

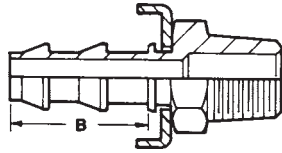

Part Number	Hose I.D.	Thread	Hex	Fitting Length	Barb Length
P04-102	1/4	1/8 - 27	1/2	1.43	.87
P04-104	1/4	1/4 - 18	9/16	1.66	.87
P04-106	1/4	3/8 - 18	11/16	1.66	.87
P05-106	5/16	1/4 - 18	9/16	1.66	.87
P06-102	3/8	1/8 - 27	1/2	1.53	.97
P06-104	3/8	1/4 - 18	9/16	1.76	.97
P06-106	3/8	3/8 - 18	11/16	1.76	.97
P06-108	3/8	1/2 - 14	7/8	1.97	.97
P08-104	1/2	1/4 - 18	11/16	1.76	.97
P08-106	1/2	3/8 - 18	11/16	1.76	.97
P08-108	1/2	1/2 - 14	7/8	1.97	.97
P08-112	1/2	3/4 - 14	1-1/16	1.97	.97
P10-112	5/8	3/4 - 14	1-1/16	2.45	1.45
P12-108	3/4	1/2 - 14	1-1/16	2.45	1.45
P12-112	3/4	3/4 - 14	1-1/16	2.45	1.45

JIC 37°/SAE 45° SWIVEL FEMALE STEM BRASS

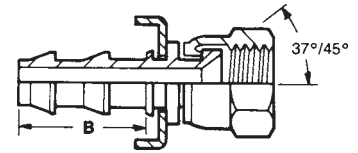

Part Number	Hose I.D.	Thread	Nut Hex	Fitting Length	Barb Length
P04-604	1/4	7/16 - 20	9/16	1.47	.87
P04-605	1/4	1/2 - 20	5/8	1.56	.87
P04-606	1/4	9/16 - 18	11/16	1.57	.87
P06-606	3/8	9/16 - 18	11/16	1.71	.97
P06-608	3/8	3/4 - 16	7/8	1.78	.97
P08-608	1/2	3/4 - 16	7/8	1.88	.97
P08-610	1/2	7/8 - 14	1	1.96	.97
P10-610	5/8	7/8 - 14	1	2.44	1.45
P12-612	3/4	1-1/16 - 12	1-1/4	2.50	1.45

SAE 45° MALE INVERTED SWIVEL STEM BRASS

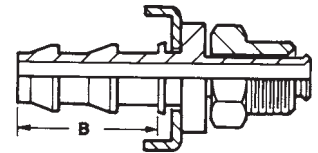

Part Number	Hose I.D.	Thread	Nut Hex	Fitting Length	Barb Length
P04-B04	1/4	7/16 - 24	7/16	1.56	.87
P04-B05	1/4	1/2 - 20	1/2	1.62	.87
P05-B05	5/16	1/2 - 20	1/2	1.62	.87
P05-B06	5/16	5/8 - 18	5/8	1.63	.87
P06-B05	3/8	1/2 - 20	1/2	1.72	.97
P06-B06	3/8	5/8 - 18	5/8	1.76	.97
P08-B08	1/2	3/4 - 18	3/4	1.84	.97

SAE 45° SOLID MALE STEM BRASS

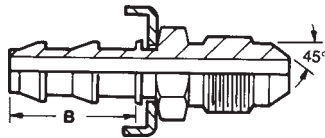

Part Number	Hose I.D.	Thread	Hex	Fitting Length	Barb Length
P06-306	3/8	5/8 - 18	5/8	1.83	.97

RIGID SHANK TUBE STEM BRASS

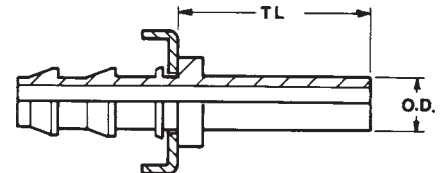

Part Number	Hose I.D.	Tube O.D.	Tube Length	Fitting Length	Barb Length
P04-RS-T04	1/4	1/4	1.06	1.89	.87
P04-RS-T05	1/4	5/16	1.06	1.89	.87
P06-RS-T06	3/8	3/8	1.06	2.03	.97
P08-RS-T08	1/2	1/2	1.06	2.13	.97

SAE 45° SWIVEL FEMALE STEM BRASS

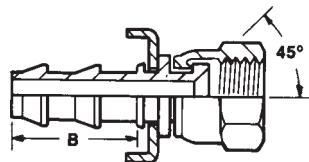

Part Number	Hose I.D.	Thread	Nut Hex	Fitting Length	Barb Length
P04-406	1/4	5/8 - 18	3/4	1.57	.87
P05-406	5/16	5/8 - 18	3/4	1.57	.87
P06-406	3/8	5/8 - 18	3/4	1.71	.97
P12-412	3/4	1-1/16 - 14	1-1/4	2.50	1.45

JIC 37° SOLID MALE STEM BRASS

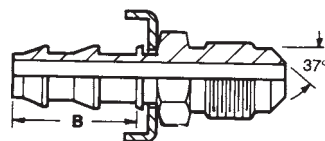

Part Number	Hose I.D.	Thread	Hex	Fitting Length	Barb Length
P04-504	1/4	7/16 - 20	1/2	1.60	.87
P04-506	1/4	9/16 - 18	5/8	1.64	.87
P06-506	3/8	9/16 - 18	5/8	1.78	.97
P06-508	3/8	3/4 - 16	13/16	1.88	.97
P08-508	1/2	3/4 - 16	7/8	1.98	.97

HOSE MENDER BRASS

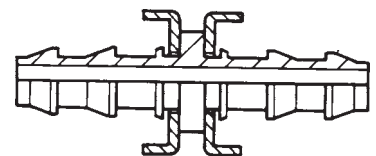

Part Number	Hose I.D.	Fitting Length	Barb Length
P04-M-H04	1/4	1.80	.87
P05-M-H05	5/16	1.80	.87
P06-M-H06	3/8	2.00	.97
P08-M-H08	1/2	2.00	.97
P10-M-H10	5/8	3.03	1.45
P12-M-H12	3/4	3.03	1.45

Hydraulic Adapters & Tube Fittings

* Available in 316
Stainless Steel



Refer to Price Book for Additional Adapters
Configurations page 85-116

302 SHORT NUT

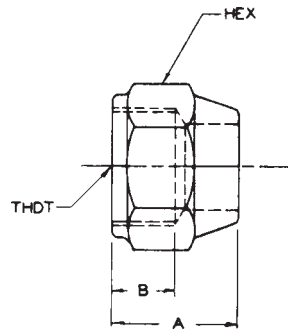

Part Number	Tube O.D.	Thread	A	B	Hex
302-4	1/4	7/16 - 20	19/32	.375	9/16
302-5	5/16	1/2 - 20	19/32	.375	5/8
302-6	3/8	9/16 - 18	21/32	.385	11/16
302-8	1/2	3/4 - 16	13/16	.438	7/8
302-10	5/8	7/8 - 14	15/16	.521	1
302-12	3/4	1-1/16 - 12	1-9/64	.594	1-1/4
302-14	7/8	1-3/16 - 12	1-13/64	.594	1-3/8
302-16	1	1-5/16 - 12	1-9/32	.625	1-1/2
302-20	1-1/4	1-5/8 - 12	1-7/16	.625	2
302-24	1-1/2	1-7/8 - 12	1-9/16	.708	2-1/4
302-32	2	2-1/2 - 12	2	.875	2-7/8

304 STANDARD NUT

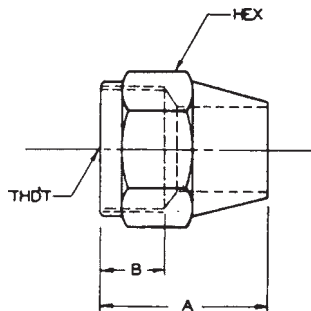

Part Number	Tube O.D.	Thread	A	B	Hex
304-4	1/4	7/16 - 20	13/16	.375	9/16
304-5	5/16	1/2 - 20	13/16	.375	5/8
304-6	3/8	9/16 - 18	15/16	.385	11/16
304-8	1/2	3/4 - 16	1-3/32	.438	7/8
304-10	5/8	7/8 - 14	1-1/4	.521	1
304-12	3/4	1-1/16 - 12	1-5/8	.594	1-1/4
304-14	7/8	1-3/16 - 12	1-3/4	.594	1-3/8
304-16	1	1-5/16 - 12	1-13/16	.625	1-1/2
304-20	1-1/4	1-5/8 - 12	1-15/16	.625	2
304-24	1-1/2	1-7/8 - 12	2-1/16	.708	2-1/4
304-32	2	2-1/2 - 12	2-5/16	.875	2-7/8

304-C CAP NUT

*

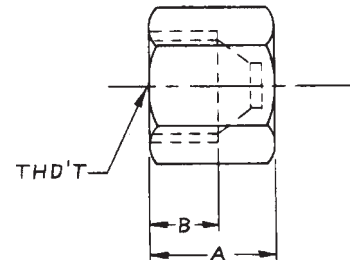

Part Number	Tube O.D.	Thread	A	B	Hex
304-C-3	3/16	3/8 - 24	-	-	-
304-C-4	1/4	7/16 - 20	19/32	.328	9/16
304-C-5	5/16	1/2 - 20	39/64	.344	5/8
304-C-6	3/8	9/16 - 18	5/8	.344	11/16
304-C-8	1/2	3/4 - 16	3/4	.375	7/8
304-C-10	5/8	7/8 - 14	27/32	.469	1
304-C-12	3/4	1-1/16 - 12	29/32	.500	1-1/4
304-C-14	7/8	1-3/16 - 12	31/32	.531	1-3/8
304-C-16	1	1-5/16 - 12	1-1/64	.563	1-1/2
304-C-20	1-1/4	1-5/8 - 12	1-1/16	.563	2
304-C-24	1-1/2	1-7/8 - 12	1-3/16	.656	2-1/4
304-C-32	2	2-1/2 - 12	1-7/16	.828	2-7/8

306 LOCK NUT

*

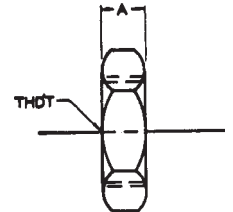

Part Number	Tube O.D.	Thread	A	Hex
306-4	1/4	7/16 - 20	1/4	11/16
306-5	5/16	1/2 - 20	1/4	3/4
306-6	3/8	9/16 - 18	17/64	13/16
306-8	1/2	3/4 - 16	5/16	1
306-10	5/8	7/8 - 14	23/64	1-1/8
306-12	3/4	1-1/16 - 12	13/32	1-3/8
306-14	7/8	1-3/16 - 12	13/32	1-1/2
306-16	1	1-5/16 - 12	13/32	1-5/8
306-20	1-1/4	1-5/8 - 12	13/32	1-7/8
306-24	1-1/2	1-7/8 - 12	13/32	2-1/8
306-32	2	2-1/2 - 12	13/32	2-3/4

306-N LOCK NUT

Part Number	Tube O.D.	Thread	A	Hex
306-N-4	1/4	7/16 - 20	1/4	9/16
306-N-5	5/16	1/2 - 20	1/4	5/8
306-N-6	3/8	9/16 - 18	17/64	11/16
306-N-8	1/2	3/4 - 16	5/16	7/8
306-N-10	5/8	7/8 - 14	23/64	1
306-N-12	3/4	1-1/16 - 12	13/32	1-1/4
306-N-14	7/8	1-3/16 - 12	13/32	1-3/8
306-N-16	1	1-5/16 - 12	13/32	1-1/2
306-N-20	1-1/4	1-5/8 - 12	13/32	1-7/8
306-N-24	1-1/2	1-7/8 - 12	13/32	2-1/8
306-N-32	2	2-1/2 - 12	13/32	2-3/4



* Available in 316
Stainless Steel

Hydraulic Adapters & Tube Fittings

318 NUT

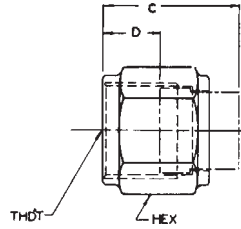

Part Number	Tube O.D.	Thread	C	D	Hex
318-2	1/8	5/16 - 24	-	-	-
318-3	3/16	3/8 - 24	-	-	-
318-4	1/4	7/16 - 20	51/64	25/64	9/16
318-5	5/16	1/2 - 20	55/64	27/64	5/8
318-6	3/8	9/16 - 18	15/16	7/16	11/16
318-8	1/2	3/4 - 16	1-1/16	1/2	7/8
318-10	5/8	7/8 - 14	1-15/64	37/64	1
318-12	3/4	1-1/16 - 12	1-9/32	39/64	1-1/4
318-14	7/8	1-3/16 - 12	1-25/64	41/64	1-3/8
318-16	1	1-5/16 - 12	1-15/32	11/16	1-1/2
318-20	1-1/4	1-5/8 - 12	1-39/64	45/64	2
318-24	1-1/2	1-7/8 - 12	1-61/64	53/64	2-1/4
318-32	2	2-1/2 - 12	2-7/8	1-1/16	2-7/8

319 SLEEVE

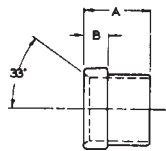

Part Number	Tube O.D.	A	B
319-2	1/8	-	-
319-3	3/16	-	-
319-4	1/4	13/32	9/64
319-5	5/16	7/16	5/32
319-6	3/8	1/2	11/64
319-8	1/2	9/16	7/32
319-10	5/8	21/32	15/64
319-12	3/4	11/16	17/64
319-14	7/8	3/4	17/64
319-16	1	25/32	9/32
319-20	1-1/4	29/32	5/16
319-24	1-1/2	1-1/8	11/32
319-32	2	1-3/16	13/32

403 BRAZE TUBE UNION

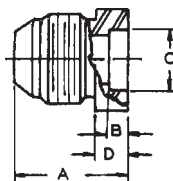

Part Number	Tube O.D.	JIC Male	A	B	C	D	Hex
403-4	1/4	7/16 - 20	47/64	.125	.254	.184	1/2
403-5	5/16	1/2 - 20	-	-	-	-	-
403-6	3/8	9/16 - 18	13/16	.140	.379	.256	5/8
403-8	1/2	3/4 - 16	15/16	.188	.504	.280	13/16
403-10	5/8	7/8 - 14	1-5/64	.218	.631	.320	15/16
403-12	3/4	1-1/16 - 12	1-13/64	.232	.756	.339	1-1/8
403-14	7/8	1-3/16 - 12	-	-	-	-	-
403-16	1	1-5/16 - 12	1-9/32	.250	1.006	.370	1-3/8
403-20	1-1/4	1-5/8 - 12	1-25/64	.312	1.256	.432	1-11/16
403-24	1-1/2	1-7/8 - 12	1-37/64	.343	1.506	.495	2
403-32	2	2-1/2 - 12	2-5/64	.343	2.006	.745	2-5/8

404 BRAZE MALE PIPE UNION

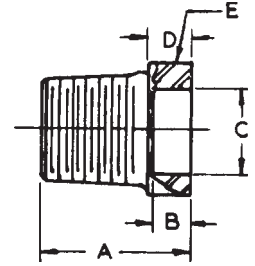

Part Number	Tube O.D.	NPTF Male	A	B	C	D	Hex
404-4-2	1/4	1/8	39/64	.125	.254	3/16	1/2
404-6-4	3/8	1/4	13/16	.140	.379	1/4	5/8
404-8-6	1/2	3/8	27/32	.188	.504	9/32	13/16
404-10-8	5/8	1/2	1-5/64	.218	.631	21/64	15/16
404-12-12	3/4	3/4	1-3/32	.232	.756	11/32	1-1/8
404-16-16	1	1	1-5/16	.250	1.006	3/8	1-3/8
404-20-20	1-1/4	1-1/4	1-13/32	.312	1.256	7/16	1-11/16
404-24-24	1-1/2	1-1/2	1-1/2	.343	1.506	1/2	2
404-32	2	2	1-25/32	.343	2.006	3/4	2-5/8

405 BRAZE FEMALE PIPE UNION

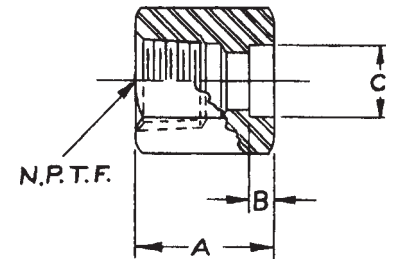

Part Number	Tube O.D.	NPTF Female	A	B	C	Hex
405-4-2	1/4	1/8	39/64	.125	.254	9/16
405-6-4	3/8	1/4	3/4	.140	.379	3/4
405-8-6	1/2	3/8	7/8	.188	.504	7/8
405-10-8	5/8	1/2	1-1/16	.218	.631	1-1/8
405-12-12	3/4	3/4	1-9/64	.232	.756	1-3/8
405-16-16	1	1	1-5/16	.250	1.006	1-5/8
405-20-20	1-1/4	1-1/4	1-33/64	.312	1.256	2
405-24-24	1-1/2	1-1/2	1-17/32	.343	1.506	2-5/16
405-32-32	2	2	1-37/64	.343	2.006	2-7/8

500 BRAZE 90° TUBE ELBOW

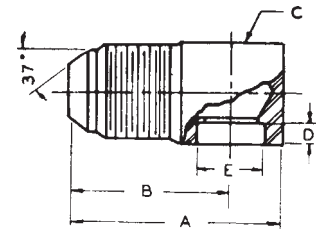

Part Number	Tube O.D.	JIC Male	A	B	C	D	E
500-4	1/4	7/16 - 20	1-9/64	57/64	1/2	.125	.254
500-5	5/16	1/2 - 20	-	-	-	-	-
500-6	3/8	9/16 - 18	1-3/8	1-1/16	5/8	.140	.379
500-8	1/2	3/4 - 16	1-21/32	1-1/4	13/16	.188	.504
500-10	5/8	7/8 - 14	1-15/16	1-29/64	15/16	.218	.631
500-12	3/4	1-1/16 - 12	2-7/32	1-21/32	1-1/8	.232	.756
500-14	7/8	1-3/16 - 12	-	-	-	-	-
500-16	1	1-5/16 - 12	2-1/2	1-13/16	1-3/8	.250	1.006
500-20	1-1/4	1-5/8 - 12	2-15/16	2-1/16	1-3/4	.312	1.256
500-24	1-1/2	1-7/8 - 12	3-5/16	2-21/64	2	.343	1.506
500-32	2	2-1/2 - 12	4-5/16	3-1/16	2-1/2	.343	2.006

Hydraulic Adapters & Tube Fittings



501 BRAZE 90° MALE PIPE ELBOW

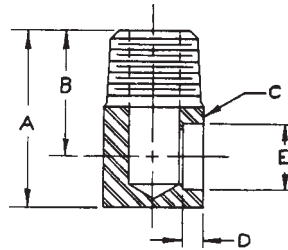

Part Number	Tube O.D.	NPTF Male	A	B	C	D	E
501-4-2	1/4	1/8	1-1/32	25/32	1/2	.125	.254
501-5-4	5/16	1/4	-	-	-	-	-
501-6-4	3/8	1/4	1-3/8	1-1/16	5/8	.140	.379
501-8-6	1/2	3/8	1-19/32	1-3/16	13/16	.188	.504
501-10-8	5/8	1/2	1-29/32	1-7/16	15/16	.218	.631
501-12-12	3/4	3/4	1-31/32	1-13/32	1-1/8	.232	.756
501-16-16	1	1	2-21/32	1-31/32	1-3/8	.250	1.006
501-20-20	1-1/4	1-1/4	3-1/4	2-3/8	1-3/4	.312	1.256
501-24-24	1-1/2	1-1/2	3-5/8	2-5/8	2	.343	1.506
501-32-32	2	2	4-1/4	3	2-1/2	.343	2.006

601 BRAZE MALE PIPE TEE

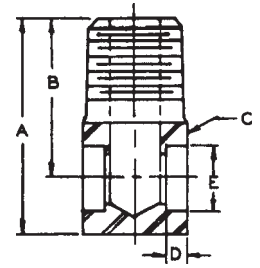

Part Number	Tube O.D.	NPTF Male	A	B	C	D	E
601-4-2	1/4	1/8	1-1/32	25/32	1/2	.125	.254
601-6-4	3/8	1/4	1-3/8	1-1/16	5/8	.140	.379
601-8-6	1/2	3/8	1-19/32	1-3/16	13/16	.188	.504
601-10-8	5/8	1/2	1-29/32	1-7/16	15/16	.218	.631
601-12-12	3/4	3/4	1-31/32	1-13/32	1-1/8	.232	.756
601-16-16	1	1	2-21/32	1-31/32	1-3/8	.250	1.006
601-20-20	1-1/4	1-1/4	3-1/4	2-3/8	1-3/4	.312	1.256
601-24-24	1-1/2	1-1/2	3-5/8	2-5/8	2	.343	1.506
601-32-32	2	2	4-1/4	3	2-1/2	.343	2.006

502 BRAZE 90° FEMALE PIPE ELBOW

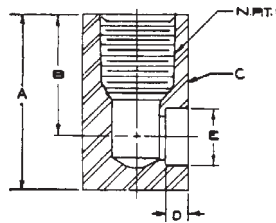

Part Number	Tube O.D.	NPTF Female	A	B	C	D	E
502-4-2	1/4	1/8	15/16	21/32	9/16	.125	.254
502-5-4	5/16	1/4	-	-	-	-	-
502-6-4	3/8	1/4	1-17/64	57/64	3/4	.140	.379
502-8-6	1/2	3/8	1-7/16	31/32	15/16	.188	.504
502-10-8	5/8	1/2	1-51/64	1-15/64	1-1/8	.218	.631
502-12-12	3/4	3/4	2	1-3/8	1-3/8	.232	.756
502-16-16	1	1	2-7/16	1-11/16	1-5/8	.250	1.006
502-20-20	1-1/4	1-1/4	2-23/64	1-31/32	2	.312	1.256
502-24-24	1-1/2	1-1/2	3-1/4	2-1/4	2-3/8	.343	1.506
502-32-32	2	2	3-13/16	2-9/16	2-7/8	.343	2.006

602 BRAZE FEMALE PIPE TEE

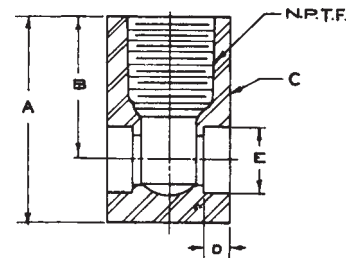

Part Number	Tube O.D.	NPTF Female	A	B	C	D	E
602-4-2	1/4	1/8	15/16	21/32	9/16	.125	.254
602-6-4	3/8	1/4	1-17/64	57/64	3/4	.140	.379
602-8-6	1/2	3/8	1-7/16	31/32	15/16	.188	.504
602-10-8	5/8	1/2	1-51/64	1-15/64	1-1/8	.218	.631
602-12-12	3/4	3/4	2	1-3/8	1-3/8	.232	.756
602-16-20-16	1 & 1-1/4	1	2-7/16	1-11/16	1-5/8	.250	1.006
602-20-20	1-1/4	1-1/4	2-23/64	1-31/32	2	.312	1.256
602-24-24	1-1/2	1-1/2	3-1/4	2-1/4	2-3/8	.343	1.506
602-32-32	2	2	3-13/16	2-9/16	2-7/8	.343	2.006

600 BRAZE TUBE TEE

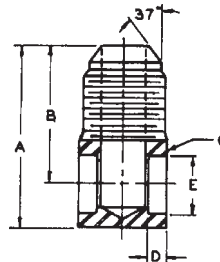

Part Number	Tube O.D.	JIC Male	A	B	C	D	E
600-4	1/4	7/16 - 20	1-9/64	57/64	1/2	.125	.254
600-5	5/16	1/2 - 20	-	-	-	-	-
600-6	3/8	9/16 - 18	1-3/8	1-1/16	5/8	.140	.379
600-8	1/2	3/4 - 16	1-21/32	1-1/4	13/16	.188	.504
600-10	5/8	7/8 - 14	1-15/16	1-29/64	15/16	.218	.631
600-12	3/4	1-1/16 - 12	2-7/32	1-21/32	1-1/8	.232	.756
600-14	7/8	1-3/16 - 12	-	-	-	-	-
600-16	1	1-5/16 - 12	2-1/2	1-13/16	1-3/8	.250	1.006
600-20	1-1/4	1-5/8 - 12	2-15/16	1-3/4	1-3/4	.312	1.256
600-24	1-1/2	1-7/8 - 12	3-5/16	2-21/64	2	.343	1.506
600-32	2	2-1/2 - 12	4-5/16	3-1/16	2-1/2	.343	2.006

603 BRAZE TUBE TEE

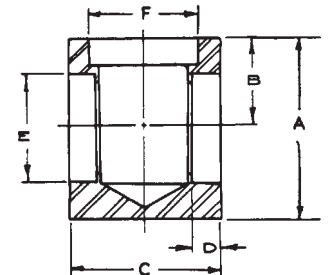

Part Number	Tube O.D.	A	B	C	D	E	F
603-4	1/4	5/8	5/16	1/2	.125	.254	.254
603-6	3/8	49/64	25/64	5/8	.140	.379	.379
603-8	1/2	1	1/2	13/16	.188	.504	.504
603-10	5/8	1-5/32	19/32	15/16	.218	.631	.631
603-12	3/4	1-29/64	43/64	1-1/8	.232	.756	.756
603-16	1	1-41/64	53/64	1-3/8	.250	1.006	1.006
603-20	1 1/4	2-1/8	1-1/16	1-3/4	.312	1.256	1.256
603-24	1 1/2	2-33/64	1-11/64	2	.343	1.506	1.506
603-32	2	2-7/8	1-7/16	2-1/2	.343	2.006	2.006



* Available in 316
Stainless Steel

Hydraulic Adapters & Tube Fittings

701 90° BRAZE TUBE ELBOW

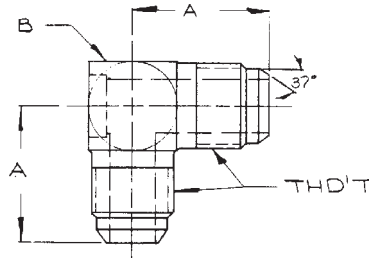

Part Number	Tube O.D.	JIC Male	A	B Min.
701-4	1/4	7/16 - 20	57/64	7/16
701-5	5/16	1/2 - 20	61/64	1/2
701-6	3/8	9/16 - 18	1-1/16	9/16
701-8	1/2	3/4 - 16	1-1/4	13/16
701-10	5/8	7/8 - 14	1-29/64	7/8
701-12	3/4	1-1/16 - 12	1-21/32	1-1/16
701-14	7/8	1-3/16 - 12	1-23/32	1-3/16
701-16	1	1-5/16 - 12	1-13/16	1-5/16
701-20	1-1/4	1-5/8 - 12	2-1/16	1-5/8
701-24	1-1/2	1-7/8 - 12	2-21/64	1-7/8
701-32	2	2-1/2 - 12	3-1/16	2-1/2

702 BRAZE TUBE TEE

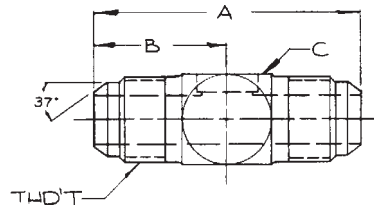

Part Number	Tube O.D.	JIC Male	A	B	C Min.
702-4	1/4	7/16-20	1-23/32	66/64	7/16
702-5	5/16	1/2-20	1-27/32	59/64	1/2
702-6	3/8	9/16-18	2-1/32	1-1/32	9/16
702-8	1/2	3/4-16	2-7/16	1-7/32	13/16
702-10	5/8	7/8-14	2-27/32	1-27/64	7/8
702-12	3/4	1-1/16-12	3-1/4	1-5/8	1-1/16
702-14	7/8	1-3/16-12	3-7/16	1-23/32	1-3/16
702-16	1	1-5/16-12	3-9/16	1-25/32	1-5/16
702-20	1-1/4	1-5/8-12	4-1/16	2-1/32	1-5/8
702-24	1-1/2	1-7/8-12	4-19/32	2-19/64	1-7/8
702-32	2	2-1/2-12	6-1/16	3-1/32	2-1/2

800 BRAZE SWIVEL UNION

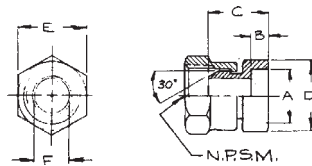

Part Number	Tube O.D.	NPSM Female	A	B	C	D	E	F
800-6-4	3/8	1/4	.379	.140	23/32	5/8	11/16	15/64
800-8-6	1/2	3/8	.504	.188	25/32	3/4	7/8	23/64
800-8-8	1/2	1/2	-	-	-	-	-	-
800-10-6	5/8	3/8	.631	.218	55/64	7/8	1	31/64
800-10-8	5/8	1/2	.756	.232	7/8	1	1	31/64
800-12-8	3/4	1/2	.756	.232	1	1	1-1/4	21/32
800-12-12	3/4	3/4	1.006	.250	1	1-1/4	1-1/4	21/32
800-14-12	7/8	1	1.006	.250	1	1-1/4	1-1/2	7/8
800-16-12	1	3/4	1.256	.312	1	1-1/2	1-1/4	21/32
800-16-16	1	1	1.006	.250	1	1-1/4	1-1/2	7/8
800-20-12	1-1/4	3/4	1.256	.312	1	1-1/2	1-1/4	21/32
800-20-16	1-1/4	1	1.256	.312	1-1/64	1-1/2	1-1/2	7/8
800-20-20	1-1/4	1-1/4	1.256	.312	1-1/8	1-5/8	1-7/8	1-5/32

801 & 802 BRAZE SWIVEL UNION 90° & 90° TEE

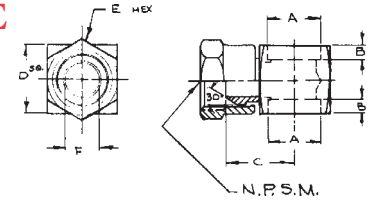

801

Part Number	Tube O.D.	NPSM Female	A	B	C	D	E	F
801-6-4	3/8	1/4	.379	.140	3/4	5/8	11/16	15/64
801-8-6	1/2	3/8	.504	.188	13/16	3/4	7/8	23/64
801-8-8	1/2	1/2	.504	.188	57/64	7/8	1	31/64
801-10-8	5/8	1/2	.631	.218	57/64	7/8	1	31/64
801-12-8	3/4	1/2	.756	.232	61/64	1	1	31/64
801-12-12	3/4	3/4	.756	.232	1-11/64	1-1/8	1-1/4	21/32
801-14-8	7/8	1/2	-	-	-	-	-	-
801-16-12	1	3/4	1.006	.250	1-3/16	1-1/4	1-1/4	21/32
801-16-16	1	1	1.006	.250	1-5/16	1-3/8	1-1/2	7/8
801-20-12	1-1/4	3/4	1.256	.312	1-23/64	1-1/2	1-1/4	21/32
801-20-16	1-1/4	1	1.256	.312	1-3/8	1-1/2	1-1/2	7/8

802

Part Number	Tube O.D.	NPSM Female	A	B	C	D	E	F
802-6-4	3/8	1/4	.379	.140	3/4	5/8	11/16	15/64
802-8-6	1/2	3/8	.504	.188	13/16	3/4	7/8	23/64
802-8-8	1/2	1/2	.504	.188	57/64	7/8	1	31/64
802-10-8	5/8	1/2	.631	.218	57/64	7/8	1	31/64
802-12-8	3/4	1/2	.756	.232	61/64	1	1	31/64
802-12-12	3/4	3/4	.756	.232	1-11/64	1-1/8	1-1/4	21/32
802-16-12	1	3/4	1.006	.250	1-3/16	1-1/4	1-1/4	21/32
802-16-16	1	1	1.006	.250	1-5/16	1-3/8	1-1/2	7/8
802-20-12	1-1/4	3/4	1.256	.312	1-23/64	1-1/2	1-1/4	21/32
802-20-16	1-1/4	1	1.256	.312	1-3/8	1-1/2	1-1/2	7/8

1404 MALE ADAPTER UNION

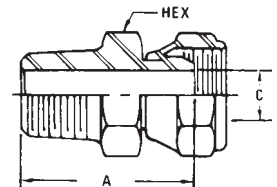

Part Number	NPTF Male	NPSM Female	A	Hex	C
1404-2-2	1/8	1/8	15/16	1/2	3/16
1404-2-4	1/8	1/4	1-1/16	-	-
1404-4-2	1/4	1/8	1-3/16	-	-
1404-4-4	1/4	1/4	1-1/4	5/8	7/32
1404-4-6	1/4	3/8	1-5/16	-	-
1404-6-4	3/8	1/4	1-5/16	-	-
1404-6-6	3/8	3/8	1-5/16	11/16	11/32
1404-6-8	3/8	1/2	1-27/64	-	-
1404-8-4	1/2	1/4	1-9/16	-	-
1404-8-6	1/2	3/8	1-9/16	-	-
1404-8-8	1/2	1/2	1-39/64	7/8	15/32
1404-8-12	1/2	3/4	1-47/64	-	-
1404-12-8	3/4	1/2	-	-	-
1404-12-12	3/4	3/4	1-47/64	1-1/16	41/64
1404-12-16	3/4	1	-	-	-
1404-16-12	1	3/4	-	-	-
1404-16-16	1	1	2	1-3/8	55/64
1404-16-20	1	1-1/4	-	-	-
1404-20-16	1-1/4	1	-	-	-
1404-20-20	1-1/4	1-1/4	2-1/16	1-3/4	1-9/64
1404-20-24	1-1/4	1-1/2	-	-	-
1404-24-20	1-1/2	1-1/4	-	-	-
1404-24-24	1-1/2	1-1/2	2-3/16	2-1/8	1-23/64
1404-32-32	2	2	2-3/8	2-5/8	1-55/64

Hydraulic Adapters & Tube Fittings

* Available in 316
Stainless Steel



1404-BL MALE ADAPTER UNION - BLANK

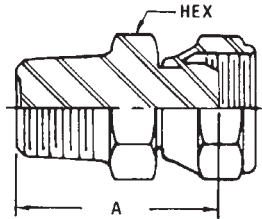

Part Number	NPTF Male	NPSM Female	A	Hex
1404-BL-2	1/8	1/8	15/16	1/2
1404-BL-4	1/4	1/4	1-1/4	5/8
1404-BL-6	3/8	3/8	1-5/16	11/16
1404-BL-8	1/2	1/2	1-39/64	7/8

1405 FEMALE ADAPTER UNION

*

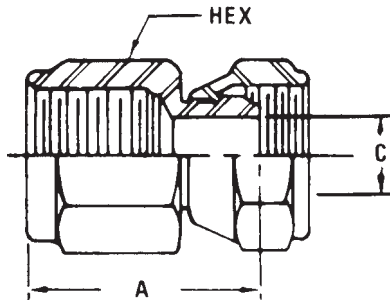

Part Number	NPTF Female	NPSM Female	A	Hex	C
1405-2-2	1/8	1/8	3/4	9/16	3/16
1405-2-4	1/8	1/4	-	-	-
1405-4-4	1/4	1/4	1-3/16	11/16	7/32
1405-4-6	1/4	3/8	-	-	-
1405-6-4	3/8	1/4	-	-	-
1405-6-6	3/8	3/8	1-7/32	13/16	11/32
1405-6-8	3/8	1/2	-	-	-
1405-8-4	1/2	1/4	-	-	-
1405-8-6	1/2	3/8	-	-	-
1405-8-8	1/2	1/2	1-13/32	1	15/32
1405-8-12	1/2	3/4	-	-	-
1405-12-8	3/4	1/2	-	-	-
1405-12-12	3/4	3/4	1-9/16	1-1/4	41/64
1405-12-16	3/4	1	-	-	-
1405-16-12	1	3/4	-	-	-
1405-16-16	1	1	1-59/64	1-1/2	55/64
1405-20-20	1-1/4	1-1/4	1-59/64	1-7/8	1-9/64
1405-24-24	1-1/2	1-1/2	1-59/64	2-1/8	1-23/64
1405-32-32	2	2	2	2-5/8	1-55/65

1406 FEMALE SWIVEL UNION

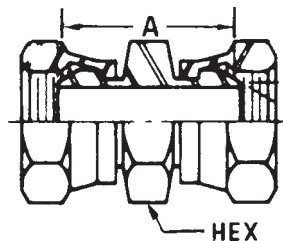

Part Number	NPSM Female	NPSM Female	A	Hex
1406-4-4	1/4	1/4	-	-
1406-6-6	3/8	3/8	-	-
1406-8-8	1/2	1/2	-	-
1406-12-12	3/4	3/4	-	-
1406-16-16	1	1	-	-

1501 MALE TO FEMALE 90°

*

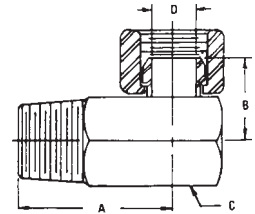

Part Number	NPTF Male	NPSM Female	A	B	C	D
1501-2-2	1/8	1/8	1	33/64	9/16	3/16
1501-2-4	1/8	1/4	-	-	-	-
1501-4-2	1/4	1/8	-	-	-	-
1501-4-4	1/4	1/4	1-1/4	3/4	11/16	7/32
1501-4-6	1/4	3/8	-	-	-	-
1501-6-4	3/8	1/4	-	-	-	-
1501-6-6	3/8	3/8	1-1/2	55/64	7/8	11/32
1501-6-8	3/8	1/2	-	-	-	-
1501-8-4	1/2	1/4	-	-	-	-
1501-8-6	1/2	3/8	-	-	-	-
1501-8-8	1/2	1/2	1-3/4	15/16	1	15/32
1501-8-12	1/2	3/4	-	-	-	-
1501-12-6	3/4	3/8	-	-	-	-
1501-12-8	3/4	1/2	-	-	-	-
1501-12-12	3/4	3/4	2	1-11/64	1-1/4	41/64
1501-12-16	3/4	1	-	-	-	-
1501-16-8	1	1/2	-	-	-	-
1501-16-12	1	3/4	-	-	-	-
1501-16-16	1	1	2-5/16	1-5/16	1-1/2	55/64
1501-16-20	1	1-1/4	-	-	-	-
1501-20-12	1-1/4	3/4	-	-	-	-
1501-20-16	1-1/4	1	-	-	-	-
1501-20-20	1-1/4	1-1/4	2-9/16	1-1/2	1-7/8	1-9/64
1501-20-24	1-1/4	1-1/2	-	-	-	-
1501-24-20	1-1/2	1-1/4	-	-	-	-
1501-24-24	1-1/2	1-1/2	2-13/16	1-39/64	2-1/8	1-23/64
1501-32-32	2	2	-	-	-	-

1502 FEMALE 90° ELBOW

*

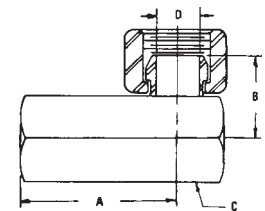

Part Number	NPTF Female	NPSM Female	A	B	C	D
1502-2-2	1/8	1/8	11/16	33/64	9/16	3/16
1502-2-4	1/8	1/4	-	-	-	-
1502-4-2	1/4	1/8	-	-	-	-
1502-4-4	1/4	1/4	15/16	3/4	11/16	7/32
1502-4-6	1/4	3/8	-	-	-	-
1502-4-8	1/4	1/2	-	-	-	-
1502-6-4	3/8	1/4	-	-	-	-
1502-6-6	3/8	3/8	1-1/16	55/64	7/8	11/32
1502-6-8	3/8	1/2	-	-	-	-
1502-8-4	1/2	1/4	-	-	-	-
1502-8-6	1/2	3/8	-	-	-	-
1502-8-8	1/2	1/2	1-1/4	15/16	1	15/32
1502-8-12	1/2	3/4	-	-	-	-
1502-12-8	3/4	1/2	-	-	-	-
1502-12-12	3/4	3/4	1-7/16	1-11/64	1-1/4	41/64
1502-12-16	3/4	1	-	-	-	-
1502-16-12	1	3/4	-	-	-	-
1502-16-16	1	1	1-3/4	1-5/16	1-1/2	55/64
1502-20-16	1-1/4	1	-	-	-	-
1502-20-20	1-1/4	1-1/4	2	1-1/2	1-7/8	1-9/64
1502-24-24	1-1/2	1-1/2	2-1/4	1-39/64	2-1/8	1-23/64
1502-32-32	2	2	-	-	-	-



* Available in 316
Stainless Steel

Hydraulic Adapters & Tube Fittings

1503 MALE SWIVEL 45° ELBOW

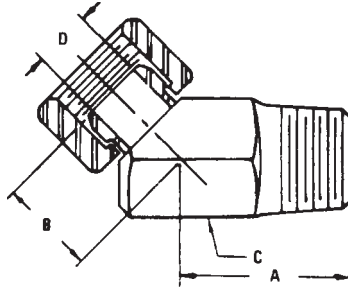

Part Number	NPTF Male	NPSM Female	A	B	C Hex	D
1503-2-2	1/8	1/8	43/64	7/16	9/16	3/16
1503-2-4	1/8	1/4	-	-	-	-
1503-4-2	1/4	1/8	-	-	-	-
1503-4-4	1/4	1/4	29/32	21/32	11/16	7/32
1503-4-6	1/4	3/8	-	-	-	-
1503-4-8	1/4	1/2	-	-	-	-
1503-6-4	3/8	1/4	-	-	-	-
1503-6-6	3/8	3/8	1-1/16	45/64	7/8	11/32
1503-6-8	3/8	1/2	-	-	-	-
1503-8-4	1/2	1/4	-	-	-	-
1503-8-6	1/2	3/8	-	-	-	-
1503-8-8	1/2	1/2	1-3/8	25/32	1	15/32
1503-8-12	1/2	3/4	-	-	-	-
1503-12-6	3/4	3/8	-	-	-	-
1503-12-8	3/4	1/2	-	-	-	-
1503-12-12	3/4	3/4	1-1/2	31/32	1-1/4	41/64
1503-12-16	3/4	1	-	-	-	-
1503-16-12	1	3/4	-	-	-	-
1503-16-16	1	1	1-1/2	1-3/64	1-1/2	55/64
1503-16-20	1	1-1/4	-	-	-	-
1503-20-16	1-1/4	1	-	-	-	-
1503-20-20	1-1/4	1-1/4	1-25/32	1-9/64	1-7/8	1-9/64
1503-24-24	1-1/2	1-1/2	1-31/32	1-7/32	2-1/8	1-23/64
1503-32-32	2	2	-	-	-	-

1504 FEMALE SWIVEL ELBOW 45°

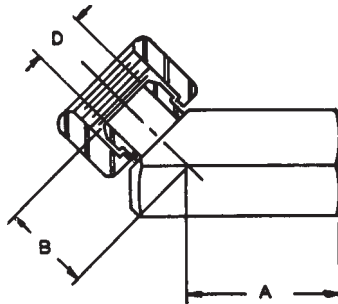

Part Number	NPTF Female	NPSM Female	A	B	C Hex	D
1504-2-2	1/8	1/8	43/64	33/64	9/16	3/16
1504-2-4	1/8	1/4	-	-	-	-
1504-4-2	1/4	1/8	-	-	-	-
1504-4-4	1/4	1/4	29/32	21/32	11/16	7/32
1504-4-6	1/4	3/8	-	-	-	-
1504-6-4	3/8	1/4	-	-	-	-
1504-6-6	3/8	3/8	1-1/16	45/64	7/8	11/32
1504-6-8	3/8	1/2	-	-	-	-
1504-8-6	1/2	3/8	-	-	-	-
1504-8-8	1/2	1/2	1-3/8	25/32	1	15/32
1504-12-8	3/4	1/2	-	-	-	-
1504-12-12	3/4	3/4	1-1/4	31/32	1-1/4	41/64
1504-16-12	1	3/4	-	-	-	-
1504-16-16	1	1	1-1/2	1-3/64	1-1/2	55/64
1504-20-20	1-1/4	1-1/4	1-25/32	1-9/64	1-7/8	1-9/64
1504-24-24	1-1/2	1-1/2	1-31/32	1-7/32	2-1/8	1-23/64

1601 MALE SWIVEL TEE

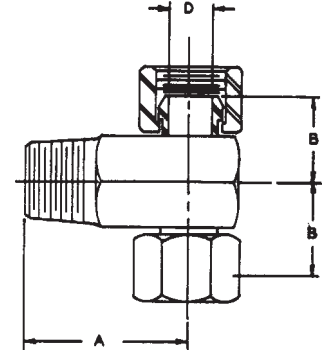

Part Number	NPTF Male	NPSM Female	A	B	C Hex	D
1601-2-2	1/8	1/8	1	7/16	9/16	3/16
1601-4-4	1/4	1/4	1-1/4	3/4	11/16	7/32
1601-6-4-4	3/8	1/4	-	-	-	-
1601-6-6	3/8	3/8	1-1/2	55/64	7/8	11/32
1601-8-4	1/2	1/4	-	-	-	-
1601-8-6-6	1/2	3/8	-	-	-	-
1601-8-8	1/2	1/2	1-3/4	15/16	1	15/32
1601-12-8-8	3/4	1/2	-	-	-	-
1601-12-12	3/4	3/4	2	1-11/64	1-1/4	41/64
1601-12-16-16	3/4	1	-	-	-	-
1601-16-16	1	1	2-5/16	1-5/16	1-1/2	55/64
1601-16-12-12	1	3/4	-	-	-	-
1601-20-20	1-1/4	1-1/4	2-9/16	1-1/2	1-7/8	1-9/64
1601-24-24	1-1/2	1-1/2	-	-	-	-

1602 FEMALE SWIVEL TEE

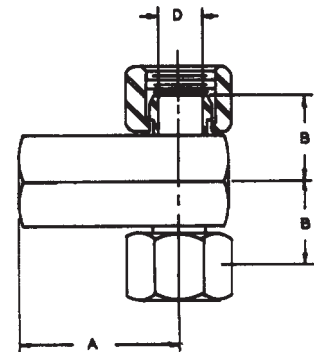

Part Number	NPTF Female	NPSM Female	A	B	C Hex	D
1602-2-2-2	1/8	1/8	-	-	-	-
1602-4-4	1/4	1/4	15/16	3/4	11/16	7/32
1602-6-4-4	3/8	1/4	-	-	-	-
1602-6-6-6	3/8	3/8	1-1/16	55/64	7/8	11/32
1602-8-6-6	1/2	3/8	-	-	-	-
1602-8-8-8	1/2	1/2	1-1/4	15/16	1	15/32
1602-12-8	3/4	1/2	-	-	-	-
1602-12-12	3/4	3/4	1-7/16	1-11/64	1-1/4	41/64
1602-16-12-12	1	3/4	-	-	-	-
1602-16-16	1	1	1-3/4	1-5/16	1-1/2	55/64
1602-20-20-20	1-1/4	1-1/4	-	-	-	-

Hydraulic Adapters & Tube Fittings



1603 SWIVEL TEE

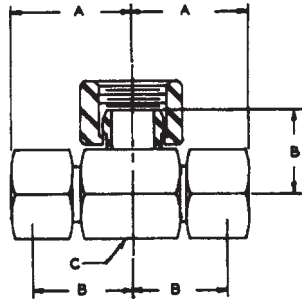

Part Number	NPSM Female	A	B	C Hex	D
1603-2-2	1/8	13/16	33/64	9/16	3/16
1603-4-4	1/4	1-1/8	3/4	11/16	7/32
1603-6-6	3/8	1-7/32	55/64	7/8	11/32
1603-8-8	1/2	1-13/32	15/16	1	15/32
1603-12-12	3/4	1-23/32	1-11/64	1-1/4	41/64
1603-16-16	1	1-7/8	1-5/16	1-1/2	55/64
1603-20-20	1-1/4	2-5/32	1-1/2	1-7/8	1-9/64

1703 45° FLANGE ADAPTER UNION Code 61

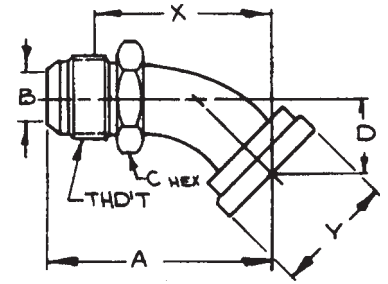

Part Number	Tube O.D.	JIC Male	Flange Size	A	B	C	D	X*	Y
1703-12-12	3/4	1-1/16 - 12	3/4	3-5/64	39/64	1-1/8	1	2-3/8	1-1/2
1703-16-16	1	1-5/16 - 12	1	3-13/64	27/32	1-3/8	1-1/8	2-7/16	1-3/4
1703-20-20	1-1/4	1-5/8 - 12	1-1/4	3-15/32	1-5/4	1-11/16	1-1/8	2-21/32	2
1703-24-24	1-1/2	1-7/8 - 12	1-1/2	3-17/32	1-5/16	2	1-1/8	2-21/32	2-3/8
1703-32-32	2	2-1/2 - 12	2	4-7/64	1-25/32	2-5/8	1-1/4	2-29/32	2-13/16

1700 STRAIGHT FLANGE ADAPTER UNION Code 61

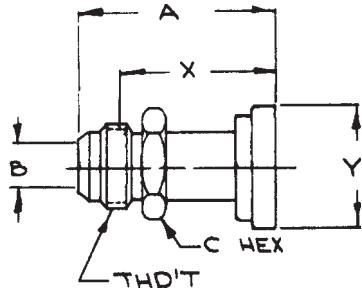

Part Number	Tube O.D.	JIC Male	Flange Size	A	B	C	X*	Y
1700-8-8	1/2	3/4 - 16	1/2	-	-	-	-	1-3/16
1700-8-12	1/2	3/4 - 16	3/4	-	-	-	-	1-1/2
1700-12-12	3/4	1-1/16 - 12	3/4	2-19/32	39/64	1-1/8	1-7/8	1-1/2
1700-12-16	3/4	1-1/16 - 12	1	-	-	-	-	1-3/4
1700-12-20	3/4	1-1/16 - 12	1-1/4	-	-	-	-	2
1700-16-12	1	1-5/16 - 12	3/4	-	-	-	-	1-1/2
1700-16-16	1	1-5/16 - 12	1	2-41/64	27/32	1-3/8	1-7/8	1-3/4
1700-16-20	1	1-5/16 - 12	1-1/4	-	27/32	1-3/8	1-7/8	2
1700-16-24	1	1-5/16 - 12	1-1/2	-	-	-	-	2-3/8
1700-20-20	1-1/4	1-5/8 - 12	1-1/4	2-11/16	1-5/64	1-11/16	1-7/8	2
1700-20-16	1-1/4	1-5/8 - 12	1	2-3/4	27/32	1-11/16	2-5/16	1-3/4
1700-20-24	1-1/4	1-5/8 - 12	1-1/2	2-7/8	1-5/64	1-11/16	2-1/8	2-3/8
1700-24-20	1-1/2	1-7/8 - 12	1-1/4	-	-	-	-	2
1700-24-24	1-1/2	1-7/8 - 12	1-1/2	3	1-5/16	2	2-1/8	2-3/8
1700-24-32	1-1/2	1-7/8 - 12	2	-	-	-	-	2-13/16
1700-32-32	2	2-1/2 - 12	2	3-5/16	1-25/32	2-5/8	2-1/8	2-13/16

1704 90° FLANGE ADAPTER UNION Code 61

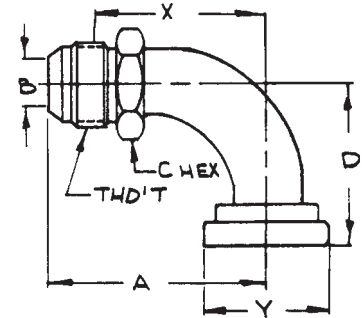

Part Number	Tube O.D.	JIC Male	Flange Size	A	B	C	D	X*	Y
1704-12-12	3/4	1-1/16 - 12	3/4	2-27/32	39/64	1-1/8	2-1/8	2-5/32	1-1/2
1704-16-16	1	1-5/16 - 12	1	3-9/64	27/32	1-3/8	2-3/8	2-3/8	1-3/4
1704-20-20	1-1/4	1-5/8 - 12	1-1/4	3-21/64	1-5/64	1-11/16	2-1/2	2-17/32	2
1704-24-24	1-1/2	1-7/8 - 12	1-1/2	3-43/64	1-5/16	2	2-3/4	2-13/16	2-3/8
1704-32-32	2	2-1/2 - 12	2	4-7/16	1-25/32	2-5/8	3-1/4	3-3/4	2-3/16



* Available in 316
Stainless Steel

Hydraulic Adapters & Tube Fittings

2403 STRAIGHT TUBE UNION

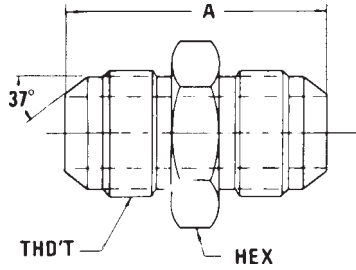

Part Number	Tube O.D.	JIC Male	A	Hex
2403-2-2	1/8	5/16 - 24	-	-
2403-3-2	3/16	3/8 - 24	-	-
2403-3-3	3/16	3/8 - 24	-	-
2403-4-2	1/4	5/16 - 24	-	-
2403-4-3	1/4	3/8 - 24	-	-
2403-4-4	1/4	7/16 - 20	1-1/4	1/2
2403-5-4	5/16	7/16 - 20	-	-
2403-5-5	5/16	1/2 - 20	1-1/4	9/16
2403-6-4	3/8	7/16 - 20	-	-
2403-6-5	3/8	1/2 - 20	-	-
2403-6-6	3/8	9/16 - 18	1-3/8	5/8
2403-8-4	1/2	7/16 - 20	-	-
2403-8-5	1/2	1/2 - 20	-	-
2403-8-6	1/2	9/16 - 18	-	-
2403-8-8	1/2	3/4 - 16	1-9/16	13/16
2403-10-4	5/8	7/16 - 20	-	-
2403-10-5	5/8	1/2 - 20	-	-
2403-10-6	5/8	9/16 - 18	-	-
2403-10-8	5/8	3/4 - 16	-	-
2403-10-10	5/8	7/8 - 14	1-53/64	15/16
2403-12-4	3/4	7/16 - 20	-	-
2403-12-5	3/4	1/2 - 20	-	-
2403-12-6	3/4	9/16 - 18	-	-
2403-12-8	3/4	3/4 - 16	-	-
2403-12-10	3/4	7/8 - 14	-	-
2403-12-12	3/4	1-1/16 - 12	2-7/64	1-1/8
2403-14-12	7/8	1-1/16 - 12	-	-
2403-14-14	7/8	1-3/16 - 12	2-5/32	1-1/4
2403-16-6	1	3/8	-	-
2403-16-8	1	1/2	-	-
2403-16-10	1	7/8 - 14	-	-
2403-16-12	1	1-1/16 - 12	-	-
2403-16-14	1	1-3/16 - 12	-	-
2403-16-16	1	1-5/16 - 12	2-3/16	1-3/8
2403-20-12	1-1/4	1-1/16 - 12	-	-
2403-20-16	1-1/4	1-5/16 - 12	-	-
2403-20-20	1-1/4	1-5/8 - 12	2-9/32	1-11/16
2403-24-20	1-1/2	1-5/8 - 12	-	-
2403-24-24	1-1/2	1-7/8 - 12	-	-
2403-32-32	2	2-1/2 - 12	-	-

2403-LH STRAIGHT TUBE UNION LARGE HEX

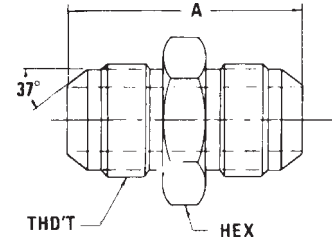

Part Number	Tube O.D.	JIC Male	A	Hex
2403-LH-4	1/4	7/16 - 20	1-3/8	11/16
2403-LH-5	5/16	1/2 - 20	1-3/8	3/4
2403-LH-6	3/8	9/16 - 18	1-13/32	13/16
2403-LH-8	1/2	3/4 - 16	1-5/8	1
2403-LH-10	5/8	7/8 - 14	1-7/8	1-1/8
2403-LH-12	3/4	1-1/16 - 12	2-1/64	1-3/8
2403-LH-16	1	1-5/16 - 12	2-1/4	1-5/8
2403-LH-20	1-1/4	1-5/8 - 12	2-7/16	1-7/8
2403-LH-24	1-1/2	1-7/8 - 12	2-3/4	2-1/2

2404 STRAIGHT ADAPTER UNION

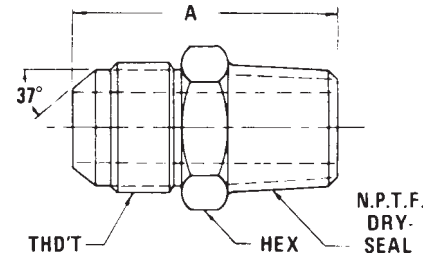

Part Number	Tube O.D.	JIC Male	NPTF Male	A	Hex
2404-2-2	1/8	5/16 - 24	1/8	-	-
2404-3-2	3/16	3/8 - 24	1/8	-	-
2404-4-2	1/4	7/16 - 20	1/8	1-7/64	1/2
2404-4-4	1/4	7/16 - 20	1/4	-	-
2404-4-6	1/4	7/16 - 20	3/8	-	-
2404-4-8	1/4	7/16 - 20	1/2	-	-
2404-5-2	5/16	1/2 - 20	1/8	1-9/64	9/16
2404-5-4	5/16	1/2 - 20	1/4	-	-
2404-5-6	5/16	1/2 - 20	3/8	-	-
2404-6-2	3/8	9/16 - 18	1/8	-	-
2404-6-4	3/8	9/16 - 18	1/4	1-3/8	5/8
2404-6-6	3/8	9/16 - 18	3/8	-	-
2404-6-8	3/8	9/16 - 18	1/2	-	-
2404-6-12	3/8	9/16 - 18	3/4	-	-
2404-8-4	3/8	3/4 - 16	1/4	-	-
2404-8-6	1/2	3/4 - 16	3/8	1-1/2	13/16
2404-8-8	1/2	3/4 - 16	1/2	-	-
2404-8-12	1/2	3/4 - 16	3/4	-	-
2404-8-16	1/2	3/4 - 16	1	-	-
2404-10-6	5/8	7/8 - 14	3/8	-	-
2404-10-8	5/8	7/8 - 14	1/2	1-53/64	15/16
2404-10-12	5/8	7/8 - 14	3/4	-	-
2404-12-6	3/4	1-1/16 - 12	3/8	-	-
2404-12-8	3/4	1-1/16 - 12	1/2	-	-
2404-12-12	3/4	1-1/16 - 12	3/4	1-61/64	1-1/8
2404-12-16	3/4	1-1/16 - 12	1	-	-
2404-14-12	7/8	1-3/16 - 12	3/4	2-1/16	1-1/4
2404-16-12	1	1-5/16 - 12	3/4	-	-
2404-16-16	1	1-5/16 - 12	1	2-7/32	1-3/8
2404-16-20	1	1-5/16 - 12	1-1/4	-	-
2404-16-24	1	1-5/16 - 12	1-1/2	-	-
2404-20-16	1-1/4	1-5/8 - 12	1	-	-
2404-20-20	1-1/4	1-5/8 - 12	1-1/4	2-23/64	1-11/16
2404-20-24	1-1/4	1-5/8 - 12	1-1/2	-	-
2404-24-20	1-1/2	1-7/8 - 12	1-1/4	-	-
2404-24-24	1-1/2	1-7/8 - 12	1-1/2	-	-
2404-32-32	2	2-1/2 - 12	2	-	-

Hydraulic Adapters & Tube Fittings

* Available in 316 Stainless Steel



2404-L STRAIGHT ADAPTER MALE

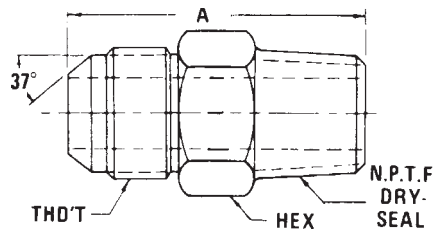

Part Number	Tube O.D.	JIC Male	NPTF Male	A	Hex
2404-L-4-2	1/4	7/16 - 20	1/8	1-13/16	1/2
2404-L-4-4	1/4	7/16 - 20	1/4	-	-
2404-L-6-4	3/8	9/16 - 18	1/4	2-1/4	5/8
2404-L-6-6	3/8	9/16 - 18	3/8	-	-
2404-L-8-6	1/2	3/4 - 16	3/8	2-3/4	13/16
2404-L-8-8	1/2	3/4 - 16	1/2	-	-
2404-L-10-8	5/8	7/8 - 14	1/2	3-1/8	15/16
2404-L-12-12	3/4	1-1/16 - 12	3/4	3-1/2	1-1/8
2404-L-16-16	1	1-5/16 - 12	1	4	1-3/8
2404-L-20-20	1-1/4	1-5/8 - 12	1-1/4	4-1/2	1-11/16

2405 STRAIGHT ADAPTER FEMALE

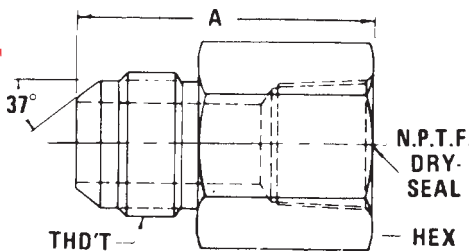

Part Number	Tube O.D.	JIC Male	NPTF Female	A	Hex
2405-3-2	3/16	3/8 - 24	1/8	-	-
2405-3-4	3/16	3/8 - 24	1/4	-	-
2405-4-2	1/4	7/16 - 20	1/8	1-5/32	9/16
2405-4-4	1/4	7/16 - 20	1/4	-	-
2405-4-6	1/4	7/16 - 20	3/8	-	-
2405-5-2	5/16	1/2 - 20	1/8	1-3/16	9/16
2405-5-4	5/16	1/2 - 20	1/4	-	-
2405-6-4	5/16	1/2 - 20	3/8	1-5/16	3/4
2405-6-6	3/8	9/16 - 18	3/8	-	-
2405-6-8	3/8	9/16 - 18	1/2	-	-
2405-8-6	1/2	3/4 - 16	3/8	1-17/32	7/8
2405-8-8	1/2	3/4 - 16	1/2	-	-
2405-8-12	1/2	3/4 - 16	3/4	-	-
2405-10-6	5/8	7/8 - 14	3/8	-	-
2405-10-8	5/8	7/8 - 14	1/2	1-13/16	1-1/8
2405-10-12	5/8	7/8 - 14	3/4	-	-
2405-12-8	3/4	1-1/16 - 12	1/2	-	-
2405-12-12	3/4	1-1/16 - 12	3/4	2	1-3/8
2405-12-16	3/4	1-1/16 - 12	1	-	-
2405-14-12	7/8	1-3/16 - 12	3/4	2	1-3/8
2405-14-16	7/8	1-3/16 - 12	1	-	-
2405-16-12	1	1-5/16 - 12	3/4	-	-
2405-16-16	1	1-5/16 - 12	1	2-7/32	1-5/8
2405-20-20	1-1/4	1-5/8 - 12	1-1/4	2-15/32	2
2405-24-24	1-1/2	1-7/8 - 12	1-1/2	-	-
2405-32-32	2	2-1/2 - 12	2	-	-

2406 TUBE REDUCER

* Available in 316 Stainless Steel

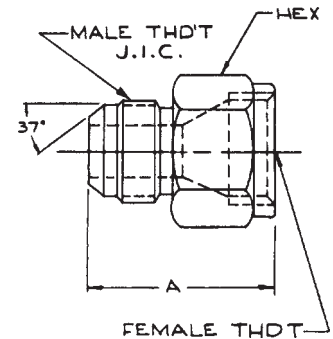

Part Number	Tube O.D.	JIC Female	JIC Male	Tube O.D.	A	Hex
2406-4-6	1/4	7/16 - 20	9/16 - 18	-	-	-
2406-6-4	3/8	9/16 - 18	7/16 - 20	1/4	1-3/16	11/16
2406-6-8	3/8	9/16 - 18	3/4 - 16	-	-	-
2406-8-4	1/2	3/4 - 16	7/16 - 20	-	-	-
2406-8-6	1/2	3/4 - 16	9/16 - 18	3/8	1-21/64	7/8
2406-8-10	1/2	3/4 - 16	7/8 - 14	-	-	-
2406-8-12	1/2	3/4 - 16	1 1/16 - 12	-	-	-
2406-10-4	5/8	7/8 - 14	7/16 - 20	-	-	-
2406-10-6	5/8	7/8 - 14	9/16 - 18	-	-	-
2406-10-8	5/8	7/8 - 14	3/4 - 16	1/2	1-13/32	1
2406-12-4	3/4	1-1/16 - 12	7/16 - 20	-	-	-
2406-12-6	3/4	1-1/16 - 12	9/16 - 18	-	-	-
2406-12-8	3/4	1-1/16 - 12	3/4 - 16	-	-	-
2406-12-10	3/4	1-1/16 - 12	7/8 - 14	5/8	1-41/64	1-1/4
2406-12-16	3/4	1-1/16 - 12	1-5/16 - 12	-	-	-
2406-14-6	7/8	1-3/16 - 12	9/16 - 18	-	-	-
2406-14-8	7/8	1-3/16 - 12	3/4 - 16	-	-	-
2406-14-10	7/8	1-3/16 - 12	7/8 - 14	-	-	-
2406-14-12	7/8	1-3/16 - 12	1-1/16 - 12	3/4	1-29/32	1-3/8
2406-16-8	1	1-5/16 - 12	3/4 - 16	-	-	-
2406-16-10	1	1-5/16 - 12	7/8 - 14	-	-	-
2406-16-12	1	1-5/16 - 12	1-1/16 - 12	-	-	-
2406-16-14	1	1-5/16 - 12	1-3/16 - 12	7/8	1-59/64	1-1/2
2406-16-20	1	1-5/16 - 12	1-5/8 - 12	-	-	-
2406-20-12	1-1/4	1-5/8 - 12	1-1/16 - 12	-	-	-
2406-20-16	1-1/4	1-5/8 - 12	1-5/16 - 12	1	2-5/32	2
2406-24-20	1-1/2	1-7/8 - 12	1-5/8 - 12	1-1/4	2-5/32	2-1/4
2406-32-24	2	2-1/2 - 12	1-7/8 - 12	1-1/2	2-21/32	2-7/8

2407 JIC REDUCER LESS NUT

* Available in 316 Stainless Steel

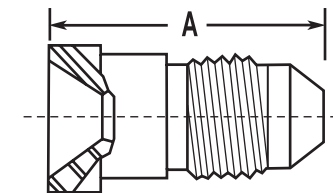

Part Number	Tube O.D.	JIC Female	JIC Male	A
2407-6-4	3/8	9/16 - 18	7/16 - 20	-
2407-8-4	1/2	3/4 - 16	7/16 - 20	-
2407-8-6	1/2	3/4 - 16	9/16 - 18	-
2407-10-4	5/8	7/8 - 14	7/16 - 20	-
2407-10-6	5/8	7/8 - 14	9/16 - 18	-
2407-12-4	3/4	1-1/16 - 12	7/16 - 20	-
2407-12-6	3/4	1-1/16 - 12	9/16 - 18	-
2407-12-8	3/4	1-1/16 - 12	3/4 - 16	-
2407-16-12	1	1-5/16 - 12	1-1/16 - 12	-
2407-20-12	1-1/4	1-5/8 - 12	1-1/16 - 12	-
2407-20-16	1-1/4	1-5/8 - 12	1-5/16 - 12	-
2407-24-20	1-1/2	1-7/8 - 12	1-5/8 - 12	-



* Available in 316
Stainless Steel

Hydraulic Adapters & Tube Fittings

2408 PLUG

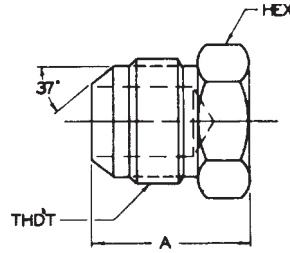

Part Number	Tube O.D.	JIC Male	A	Hex
2408-3	3/16	3/8 - 24	-	-
2408-4	1/4	7/16 - 20	47/64	1/2
2408-5	5/16	1/2 - 20	49/64	9/16
2408-6	3/8	9/16 - 18	13/16	5/8
2408-8	1/2	3/4 - 16	15/16	13/16
2408-10	5/8	7/8 - 14	1-7/64	15/16
2408-12	3/4	1-1/16 - 12	1-13/64	1-1/8
2408-14	7/8	1-3/16 - 12	1-15/4	1-1/4
2408-16	1	1-5/16 - 12	1-9/16	1-3/8
2408-20	1-1/4	1-5/8 - 12	1-23/64	1-11/16
2408-24	1-1/2	1-7/8 - 12	1-31/64	2
2408-32	2	2-1/2 - 12	1-47/64	2-5/8

2501 90° MALE ELBOW

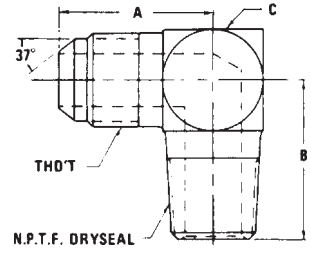

Part Number	Tube O.D.	JIC Male	NPTF Male	A	B	C Min.
2501-2-2	1/8	5/16 - 24	1/8	-	-	-
2501-3-2	3/16	3/8 - 24	1/8	-	-	-
2501-4-2	1/4	7/16 - 20	1/8	57/64	25/32	7/16
2501-4-4	1/4	7/16 - 20	1/4	-	-	-
2501-4-6	1/4	7/16 - 20	3/8	-	-	-
2501-4-8	1/4	7/16 - 20	1/2	-	-	-
2501-5-2	5/16	1/2 - 20	1/8	61/64	25/32	1/2
2501-5-4	5/16	1/2 - 20	1/4	-	-	-
2501-5-6	5/16	1/2 - 20	3/8	-	-	-
2501-6-2	3/8	9/16 - 18	1/8	-	-	-
2501-6-4	3/8	9/16 - 18	1/4	1-1/16	1-3/32	9/16
2501-6-6	3/8	9/16 - 18	3/8	-	-	-
2501-6-8	3/8	9/16 - 18	1/2	-	-	-
2501-6-12	3/8	9/16 - 18	3/4	-	-	-
2501-8-4	1/2	3/4 - 16	1/4	-	-	-
2501-8-6	1/2	3/4 - 16	3/8	1-1/4	1-7/32	3/4
2501-8-8	1/2	3/4 - 16	1/2	-	-	-
2501-8-12	1/2	3/4 - 16	3/4	-	-	-
2501-10-6	5/8	7/8 - 14	3/8	-	-	-
2501-10-8	5/8	7/8 - 14	1/2	1-29/64	1-15/32	7/8
2501-10-12	5/8	7/8 - 14	3/4	-	-	-
2501-12-6	3/4	1-1/16 - 12	3/8	-	-	-
2501-12-8	3/4	1-1/16 - 12	1/2	-	-	-
2501-12-12	3/4	1-1/16 - 12	3/4	1-21/32	1-19/32	1-1/16
2501-12-16	3/4	1-1/16 - 12	1	-	-	-
2501-14-12	7/8	1-3/16 - 12	3/4	1-23/32	1-11/16	1-3/16
2501-16-12	1	1-5/16 - 12	3/4	-	-	-
2501-16-16	1	1-5/16 - 12	1	1-13/16	1-31/32	1-5/16
2501-16-20	1	1-5/16 - 12	1-1/4	-	-	-
2501-20-16	1-1/4	1-5/8 - 12	1	-	-	-
2501-20-20	1-1/4	1-5/8 - 12	1-1/4	2-1/16	2-3/8	1-5/8
2501-20-24	1-1/4	1-5/8 - 12	1-1/2	-	-	-
2501-24-20	1-1/2	1-7/8 - 12	1-1/4	-	-	-
2501-24-24	1-1/2	1-7/8 - 12	1-1/2	2-21/64	2-5/8	1-7/8
2501-32-32	2	2-1/2 - 12	2	3-1/16	3	2-1/2

2500 90° TUBE ELBOW

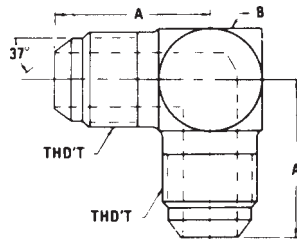

Part Number	Tube O.D.	JIC Male	JIC Male	A	B Min.
2500-4	1/4	7/16 - 20	7/16 - 20	57/64	7/16
2500-5	5/16	1/2 - 20	1/2 - 20	61/64	1/2
2500-6-4	3/8	9/16 - 18	7/16 - 20	-	-
2500-6	3/8	9/16 - 18	9/16 - 18	1-1/16	9/16
2500-8-6	1/2	3/4 - 16	9/16 - 18	-	-
2500-8	1/2	3/4 - 16	3/4 - 16	1-1/4	13/16
2500-10-8	5/8	7/8 - 14	3/4 - 16	-	-
2500-10	5/8	7/8 - 14	7/8 - 14	1-29/64	7/8
2500-12-10	3/4	1-1/16 - 12	7/8 - 14	-	-
2500-12	3/4	1-1/16 - 12	1-1/16 - 12	1-21/32	1-1/16
2500-14	7/8	1-3/16 - 12	1-3/16 - 12	1-23/32	1-3/16
2500-16	1	1-5/16 - 12	1-5/16 - 12	1-13/16	1-5/16
2500-20	1-1/4	1-5/8 - 12	1-5/8 - 12	2-1/16	1-5/8
2500-24	1-1/2	1-7/8 - 12	1-7/8 - 12	2-21/64	1-7/8
2500-32	2	2-1/2 - 12	2-1/2 - 12	3-1/16	2-1/2

Hydraulic Adapters & Tube Fittings

* Available in 316
Stainless Steel



2501-L 90° MALE ELBOW LONG

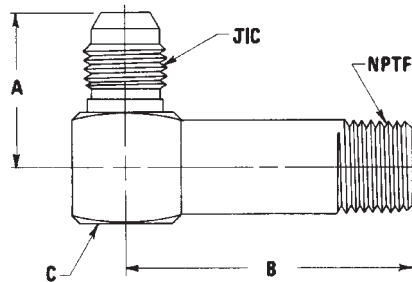

Part Number	Tube O.D.	JIC Male	NPTF Male	A	B	C
2501-L-4-2	1/4	7/16 - 20	1/8	-	-	-
2501-L-4-4	1/4	7/16 - 20	1/4	-	-	-
2501-L-5-2	5/16	1/2 - 20	1/8	-	-	-
2501-L-5-4	5/16	1/2 - 20	1/4	-	-	-
2501-L-6-4	3/8	9/16 - 18	1/4	-	-	-
2501-L-6-6	3/8	9/16 - 18	3/8	-	-	-
2501-L-8-6	1/2	3/4 - 16	3/8	-	-	-
2501-L-8-8	1/2	3/4 - 16	1/2	-	-	-
2501-L-8-12	1/2	3/4 - 16	3/4	-	-	-
2501-L-10-8	5/8	7/8 - 14	1/2	-	-	-
2501-L-12-12	3/4	1-1/16 - 12	3/4	-	-	-
2501-L-14-12	7/8	1-3/16 - 12	3/4	-	-	-
2501-L-16-16	1	1-5/16 - 12	1	-	-	-
2501-L-20-20	1-1/4	1-5/8 - 12	1-1/4	-	-	-
2501-L-24-24	1-1/2	1-7/8 - 12	1-1/2	-	-	-

2502 90° FEMALE ELBOW

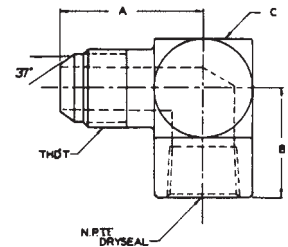

Part Number	Tube O.D.	JIC Male	NPTF Female	A	B	C Min.
2502-4-2	1/4	7/16 - 20	1/8	1-1/16	41/64	9/16
2502-4-4	1/4	7/16 - 20	1/4	-	-	-
2502-5-2	5/16	1/2 - 20	1/8	1-1/16	41/64	9/16
2502-5-4	5/16	1/2 - 20	1/4	-	-	-
2502-6-2	3/8	9/16 - 18	1/8	-	-	-
2502-6-4	3/8	9/16 - 18	1/4	1-7/32	57/64	3/4
2502-6-6	3/8	9/16 - 18	3/8	-	-	-
2502-6-8	3/8	9/16 - 18	1/2	-	-	-
2502-8-4	1/2	3/4 - 16	1/4	-	-	-
2502-8-6	1/2	3/4 - 16	3/8	1-13/32	31/32	7/8
2502-8-8	1/2	3/4 - 16	1/2	-	-	-
2502-10-8	5/8	7/8 - 14	1/2	1-5/8	1-15/64	1-1/16
2502-12-8	3/4	1-1/16 - 12	1/2	-	-	-
2502-12-12	3/4	1-1/16 - 12	3/4	1-7/8	1-11/32	1-5/16
2502-14-12	7/8	1-3/16 - 12	3/4	1-27/32	1-11/32	1-5/16
2502-16-16	1	1-5/16 - 12	1	2-5/32	1-5/8	1-5/8
2502-20-20	1-1/4	1-5/8 - 12	1-1/4	2-5/16	1-11/16	1-7/8
2502-24-24	1-1/2	1-7/8 - 12	1-1/2	2-7/8	2-1/16	2-9/16
2502-32-32	2	2-1/2 - 12	2	3-9/32	2-3/8	2-13/16

2501-LL 90° MALE ELBOW EXTRA LONG

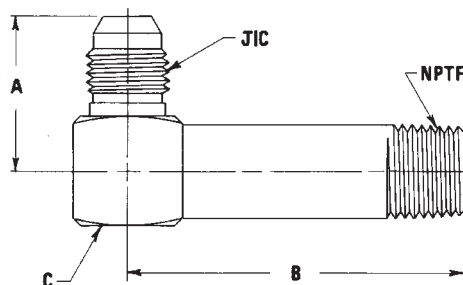

Part Number	Tube O.D.	JIC Male	NPTF Male	A	B	C
2501-LL-4-2	1/4	7/16 - 20	1/8	-	-	-
2501-LL-4-4	1/4	7/16 - 20	1/4	-	-	-
2501-LL-5-2	5/16	1/2 - 20	1/8	-	-	-
2501-LL-5-4	5/16	1/2 - 20	1/4	-	-	-
2501-LL-6-4	3/8	9/16 - 18	1/4	-	-	-
2501-LL-6-6	3/8	9/16 - 18	3/8	-	-	-
2501-LL-6-8	3/8	9/16 - 18	1/2	-	-	-
2501-LL-8-6	1/2	3/4 - 16	3/8	-	-	-
2501-LL-8-8	1/2	3/4 - 16	1/2	-	-	-
2501-LL-10-8	1/2	3/4 - 16	3/4	-	-	-
2501-LL-12-8	5/8	7/8 - 14	1/2	-	-	-
2501-LL-12-12	3/4	1-1/16 - 12	3/4	-	-	-
2501-LL-14-12	7/8	1-3/16 - 12	3/4	-	-	-
2501-LL-16-16	1	1-5/16 - 12	1	-	-	-
2501-LL-20-20	1-1/4	1-5/8 - 12	1-1/4	-	-	-
2501-LL-24-24	1-1/2	1-7/8 - 12	1-1/2	-	-	-



* Available in 316
Stainless Steel

Hydraulic Adapters & Tube Fittings

2503 45° ELBOW MALE

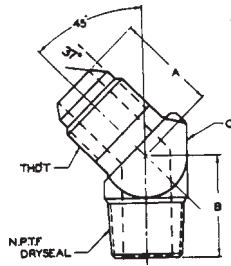

Part Number	Tube O.D.	JIC Male	NPTF Male	A	B	C Min.
2503-2-2	1/8	5/16 - 24	1/8	-	-	-
2503-3-2	3/16	3/8 - 24	1/8	-	-	-
2503-4-2	1/4	7/16 - 20	1/8	45/64	5/8	7/16
2503-4-4	1/4	7/16 - 20	1/4	-	-	-
2503-4-6	1/4	7/16 - 20	3/8	-	-	-
2503-5-2	5/16	1/2 - 20	1/8	3/4	5/8	1/2
2503-5-4	5/16	1/2 - 20	1/4	-	-	-
2503-6-2	3/8	9/16 - 18	1/8	-	-	-
2503-6-4	3/8	9/16 - 18	1/4	13/16	27/32	9/16
2503-6-6	3/8	9/16 - 18	3/8	-	-	-
2503-6-8	3/8	9/16 - 18	1/2	-	-	-
2503-8-4	1/2	3/4 - 16	1/4	-	-	-
2503-8-6	1/2	3/4 - 16	3/8	1-31/32	15/16	3/4
2503-8-8	1/2	3/4 - 16	1/2	-	-	-
2503-8-12	1/2	3/4 - 16	3/4	-	-	-
2503-10-6	5/8	7/8 - 14	3/8	-	-	-
2503-10-8	5/8	7/8 - 14	1/2	1-3/32	1-5/32	7/8
2503-10-12	5/8	7/8 - 14	3/4	-	-	-
2503-12-8	3/4	1-1/16 - 12	1/2	-	-	-
2503-12-12	3/4	1-1/16 - 12	3/4	1-17/64	1-3/16	1-1/16
2503-12-16	3/4	1-1/16 - 12	1	-	-	-
2503-14-12	7/8	1-3/16 - 12	3/4	1-3/8	1-1/4	1-3/16
2503-16-12	1	1-5/16 - 12	3/4	-	-	-
2503-16-16	1	1-5/16 - 12	1	1-29/64	1-15/32	1-5/16
2503-16-20	1	1-5/16 - 12	1-1/4	-	-	-
2503-20-16	1-1/4	1-5/8 - 12	1	-	-	-
2503-20-20	1-1/4	1-5/8 - 12	1-1/4	1-37/64	1-21/32	1-5/8
2503-24-24	1-1/2	1-7/8 - 12	1-1/2	1-49/64	1-3/4	1-7/8
2503-32-32	2	2-1/2 - 12	2	2-13/64	2-3/32	2-1/2

2504 45° TUBE ELBOW

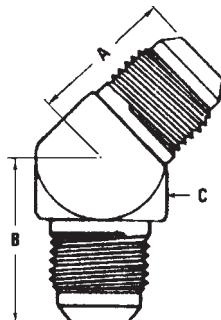

Part Number	Tube O.D.	JIC Male	JIC Male	A	B	C
2504-4-4	1/4	7/16 - 20	7/16 - 20	-	-	-
2504-6-6	3/8	9/16 - 18	9/16 - 18	-	-	-
2504-8-8	1/2	3/4 - 16	3/4 - 16	-	-	-
2504-10-10	5/8	7/8 - 14	7/8 - 14	-	-	-
2504-12-12	3/4	1-1/16 - 12	1-1/16 - 12	-	-	-
2504-16-16	1	1-5/16 - 12	1-5/16 - 12	-	-	-

2505 45° TUBE ELBOW X NPTF FEMALE

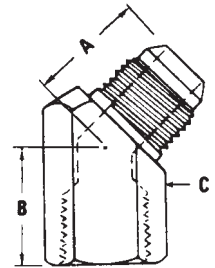

Part Number	Tube O.D.	JIC Male	NPTF Female	A	B	C
2505-6-4	3/8	9/16 - 18	1/4	-	-	-
2505-8-6	1/2	3/4 - 16	3/8	-	-	-
2505-10-8	5/8	7/8 - 14	1/2	-	-	-
2505-12-12	3/4	1-1/16 - 12	3/4	-	-	-
2505-16-16	1	1-5/16 - 12	1	-	-	-

2601 SIDE TEE MALE

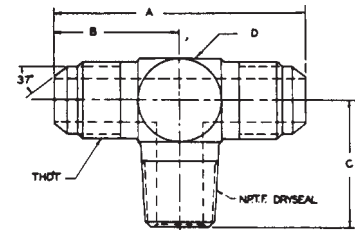

Part Number	Tube O.D.	JIC Male	NPTF Male	A	B	C	D Min.
2601-4-4-2	1/4	7/16 - 20	1/8	1-23/32	55/64	3/4	7/16
2601-4-4-4	1/4	7/16 - 20	1/4	-	-	-	-
2601-5-5-2	5/16	1/2 - 20	1/8	1-27/32	59/64	3/4	1/2
2601-5-5-4	5/16	1/2 - 20	1/4	-	-	-	-
2601-6-6-4	3/8	9/16 - 18	1/4	2-1/16	1-1/32	1-1/16	9/16
2601-6-6-6	3/8	9/16 - 18	3/8	-	-	-	-
2601-6-6-8	3/8	9/16 - 18	1/2	-	-	-	-
2601-8-8-6	1/2	3/4 - 16	3/8	2-7/16	1-7/32	1-3/16	3/4
2601-8-8-8	1/2	3/4 - 16	1/2	-	-	-	-
2601-10-10-8	5/8	7/8 - 14	1/2	2-27/32	1-27/64	1-7/16	7/8
2601-12-12-12	3/4	1-1/16 - 12	3/4	3-1/4	1-5/8	1-9/16	1-1/16
2601-14-14-12	7/8	1-3/16 - 12	3/4	3-7/16	1-23/32	1-5/8	1-3/16
2601-16-16-12	1	1-5/16 - 12	3/4	-	-	-	-
2601-16-16-16	1	1-5/16 - 12	1	3-9/16	1-25/32	1-15/16	1-5/16
2601-20-20-20	1-1/4	1-5/8 - 12	1-1/4	4-1/16	2-1/32	2-11/32	1-5/8
2601-24-24-24	1-1/2	1-7/8 - 12	1-1/2	4-19/32	2-19/64	2-5/8	1-7/8
2601-32-32-32	2	2-1/2 - 12	2	6-1/16	3-1/32	2-21/32	2-1/2

Hydraulic Adapters & Tube Fittings

* Available in 316
Stainless Steel



2602 SIDE TEE FEMALE

*

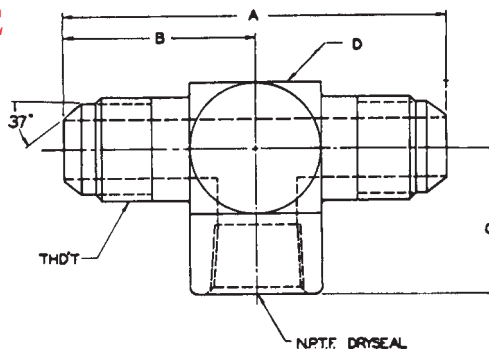

Part Number	Tube O.D.	JIC Male	NPTF Female	A	B	C	D Min.
2602-4-4-2	1/4	7/16 - 20	1/8	2-1/8	1-1/16	41/64	9/16
2602-4-4-4	1/4	7/16 - 20	1/4	-	-	-	-
2602-5-5-2	5/16	1/2 - 20	1/8	2-1/8	1-1/16	41/64	9/16
2602-6-6-4	3/8	9/16 - 18	1/4	2-7/16	1-7/32	57/64	3/4
2602-6-6-6	3/8	9/16 - 18	3/8	-	-	-	-
2602-8-8-4	1/2	3/4 - 16	1/4	-	-	-	-
2602-8-8-6	1/2	3/4 - 16	3/8	2-13/16	1-13/32	31/32	7/8
2602-8-8-8	1/2	3/4 - 16	1/2	-	-	-	-
2602-10-10-8	5/8	7/8 - 14	1/2	3-1/4	1-5/8	1-15/64	1-1/16
2602-12-12-12	3/4	1-1/16 - 12	3/4	3-3/4	1-7/8	1-11/32	1-5/16
2602-14-14-12	7/8	1-3/16 - 12	3/4	-	-	-	-
2602-16-16-16	1	1-5/16 - 12	1	4-5/16	2-5/32	1-5/8	1-5/8
2602-20-20-20	1-1/4	1-5/8 - 12	1-1/4	4-5/8	2-5/16	1-11/16	1-7/8
2602-24-24-24	1-1/2	1-7/8 - 12	1-1/2	5-3/4	2-7/8	2-1/16	2-9/16
2602-32-32-32	2	2-1/2 - 12	2	6-9/16	3-9/32	2-3/8	2-13/16

2605 RUN TEE MALE

*

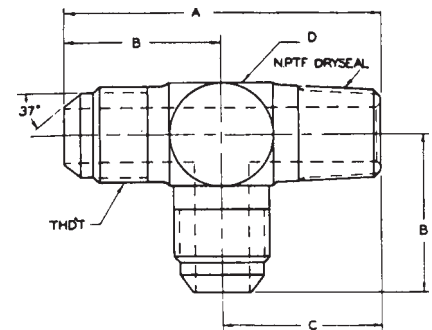

Part Number	Tube O.D.	JIC Male	NPTF Male	JIC Male	A	B	C	D Min.
2605-4-2-4	1/4	7/16 - 20	1/8	-	1-39/64	55/64	3/4	7/16
2605-4-4-4	1/4	7/16 - 20	1/4	-	-	-	-	-
2605-5-2-5	5/16	1/2 - 20	1/8	-	1-43/64	59/64	3/4	1/2
2605-6-2-6	3/8	9/16 - 18	1/8	-	-	-	-	-
2605-6-4-6	3/8	9/16 - 18	1/4	-	2-3/32	1-1/32	1-1/16	9/16
2605-6-6-4	3/8	9/16 - 18	3/8	7/16-20	-	-	-	-
2605-6-6-6	3/8	9/16 - 18	3/8	-	-	-	-	-
2605-8-6-8	1/2	3/4 - 16	3/8	-	2-13/32	1-7/32	1-3/16	3/4
2605-8-8-8	1/2	3/4 - 16	1/2	-	-	-	-	-
2605-10-8-10	5/8	7/8 - 14	1/2	-	2-55/64	1-27/64	1-7/16	7/8
2605-12-12-12	3/4	1-1/16 - 12	3/4	-	3-3/16	1-5/8	1-9/16	1-1/16
2605-14-12-14	7/8	1-3/16 - 12	3/4	-	-	-	-	-
2605-16-16-16	1	1-5/16 - 12	1	-	3-23/32	1-25/32	1-15/16	1-5/16
2605-20-20-20	1-1/4	1-5/8 - 12	1-1/4	-	4-3/8	2-1/32	2-11/32	1-5/8
2605-24-24-24	1-1/2	1-7/8 - 12	1-1/2	-	4-59/64	2-19/64	2-5/8	1-7/8
2605-32-32-32	2	2-1/2 - 12	2	-	6	3-1/32	2-31/32	2-1/2

2603 TUBE TEE

*

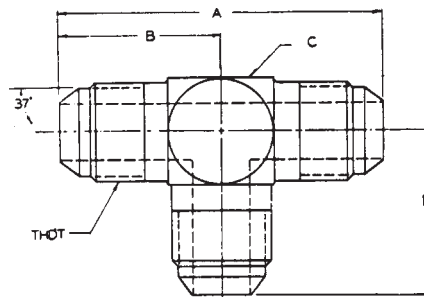

Part Number	Tube O.D.	JIC Male	JIC Male	A	B	C Min.
2603-4	1/4	7/16 - 20	7/16 - 20	1-23/32	55/64	7/16
2603-4-4-6	1/4	7/16 - 20	9/16 - 18	-	-	-
2603-5	5/16	1/2 - 20	1/2 - 20	1-27/32	59/64	1/2
2603-6	3/8	9/16 - 18	9/16 - 18	2-1/16	1-1/32	9/16
2603-6-6-8	3/8	9/16 - 18	3/4 - 16	-	-	-
2603-8	1/2	3/4 - 16	3/4 - 16	2-7/16	1-7/32	3/4
2603-10-8-8	5/8	7/8 - 14	3/4 - 16	3/4-16	-	-
2603-10-10-8	5/8	7/8 - 14	7/8 - 14	3/4-16	-	-
2603-10	5/8	7/8 - 14	7/8 - 14	2-27/32	1-27/64	7/8
2603-12	3/4	1-1/16 - 12	1-1/16 - 12	3-1/4	1-5/8	1-1/16
2603-14	7/8	1-3/16 - 12	1-3/16 - 12	3-7/16	1-23/32	1-3/16
2603-16	1	1-5/16 - 12	1-5/16 - 12	3-9/16	1-25/32	1-5/16
2603-20	1-1/4	1-5/8 - 12	1-5/8 - 12	4-1/16	2-1/32	1-5/8
2603-24	1-1/2	1-7/8 - 12	1-7/8 - 12	4-19/32	2-19/64	1-7/8
2603-32	2	2-1/2 - 12	2-1/2 - 12	6-1/16	3-1/32	2-1/2

2606 RUN TEE FEMALE

*

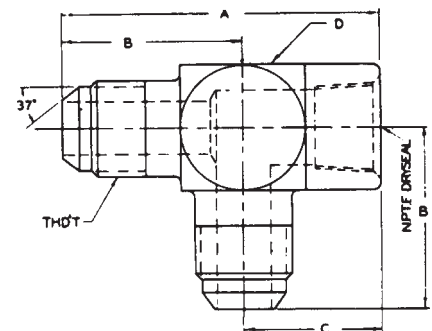

Part Number	Tube O.D.	JIC Male	NPTF Female	A	B	C	D Min.
2606-4-2-4	1/4	7/16 - 20	1/8	1-45/64	1-1/16	41/64	9/16
2606-5-2-5	5/16	1/2 - 20	1/8	1-45/64	1-1/16	41/64	9/16
2606-6-4-6	3/8	9/16 - 18	1/4	2-7/64	1-7/32	57/64	3/4
2606-8-6-8	1/2	3/4 - 16	3/8	2-3/8	1-13/32	31/32	7/8
2606-8-8-8	1/2	3/4 - 16	1/2	-	-	-	-
2606-10-8-10	5/8	7/8 - 14	1/2	2-55/64	1-5/8	1-15/64	1-1/16
2606-12-12-12	3/4	1-1/16 - 12	3/4	3-7/32	1-7/8	1-11/32	1-5/16
2606-14-12-14	7/8	1-3/16 - 12	3/4	3-3/16	1-27/32	11/32	1-5/16
2606-16-16-16	1	1-5/16 - 12	1	3-25/32	2-5/32	1-5/8	1-5/8
2606-20-20-20	1-1/4	1-5/8 - 12	1-1/4	4	2-5/16	1-11/16	1-7/8
2606-24-24-24	1-1/2	1-7/8 - 12	1-1/2	4-15/16	2-7/8	2-1/16	2-9/16



* Available in 316
Stainless Steel

Hydraulic Adapters & Tube Fittings

2613 NPTF MALE X NPTF FEMALE X JIC MALE

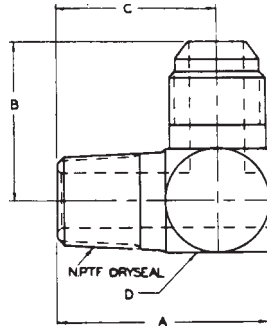

Part Number	Tube O.D.	NPTF Male	NPTF Female	JIC Male	A	B	C	D
2613-2-2-4	1/4	1/8	1/8	7/16 - 20	-	-	-	-
2613-4-4-6	3/8	1/4	1/4	9/16 - 18	-	-	-	-
2613-6-6-6	3/8	3/8	3/8	9/16 - 18	-	-	-	-
2613-6-6-8	1/2	3/8	3/8	3/4 - 16	-	-	-	-
2613-8-8-10	5/8	1/2	1/2	7/8 - 14	-	-	-	-
2613-12-12-12	3/4	3/4	3/4	1-1/16 - 12	-	-	-	-

2700 BULKHEAD TUBE UNION

*

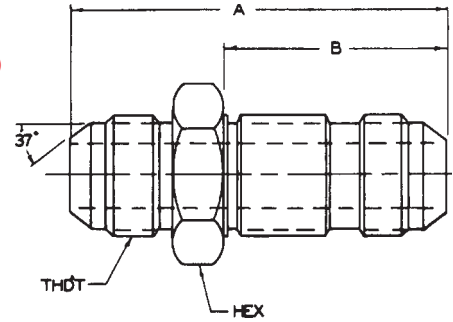

Part Number	Tube O.D.	JIC Male	A	B	Hex
2700-3	3/16	3/8 - 24	-	-	-
2700-4	1/4	7/16 - 20	2-3/64	1-13/64	11/16
2700-5	5/16	1/2 - 20	2-3/64	1-13/64	3/4
2700-6	3/8	9/16 - 18	2-7/32	1-9/32	13/16
2700-8	1/2	3/4 - 16	2-29/64	1-7/16	1
2700-10	5/8	7/8 - 14	2-23/32	1-37/64	1-1/8
2700-12	3/4	1-1/16 - 12	3-1/32	1-3/4	1-3/8
2700-14	7/8	1-3/16 - 12	3-1/16	1-3/4	1-1/2
2700-16	1	1-5/16 - 12	3-5/64	1-3/4	1-5/8
2700-20	1-1/4	1-5/8 - 12	3-5/32	1-51/64	1-7/8
2700-24	1-1/2	1-7/8 - 12	3-5/16	1-13/16	2-1/8

2650 TUBE CROSS

*

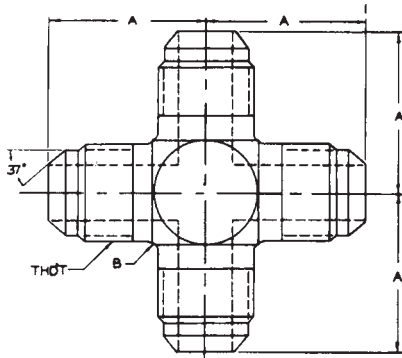

Part Number	Tube O.D.	JIC Male	A	B
2650-4	1/4	7/16 - 20	55/64	7/16
2650-5	5/16	1/2 - 20	59/64	1/2
2650-6	3/8	9/16 - 18	1-1/32	9/16
2650-8	1/2	3/4 - 16	1-7/32	3/4
2650-10	5/8	7/8 - 14	1-27/64	7/8
2650-12	3/4	1-1/16 - 12	1-5/8	1-1/16
2650-14	7/8	1-3/16 - 12	1-23/32	1-3/16
2650-16	1	1-5/16 - 12	1-25/32	1-5/16
2650-20	1-1/4	1-5/8 - 12	2-1/32	1-5/8
2650-24	1-1/2	1-7/8 - 12	2-19/64	1-7/8

2700-LN BULKHEAD TUBE UNION LOCK NUT

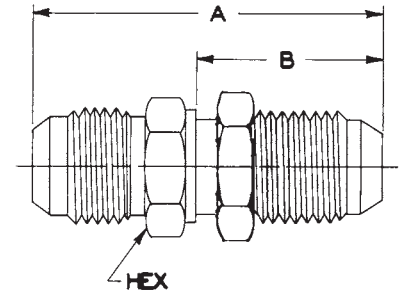

Part Number	Tube O.D.	JIC Male	A	B	Hex
2700-4-LN	1/4	7/16 - 20	-	-	-
2700-5-LN	5/16	1/2 - 20	-	-	-
2700-6-LN	3/8	9/16 - 18	-	-	-
2700-8-LN	1/2	3/4 - 16	-	-	-
2700-10-LN	5/8	7/8 - 14	-	-	-
2700-12-LN	3/4	1-1/16 - 12	-	-	-
2700-14-LN	7/8	1-3/16 - 12	-	-	-
2700-16-LN	1	1-5/16 - 12	-	-	-
2700-20-LN	1-1/4	1-5/8 - 12	-	-	-
2700-24-LN	1-1/2	1-7/8 - 12	-	-	-

Hydraulic Adapters & Tube Fittings

* Available in 316
Stainless Steel



2701 BULKHEAD TUBE ELBOW 90°

*

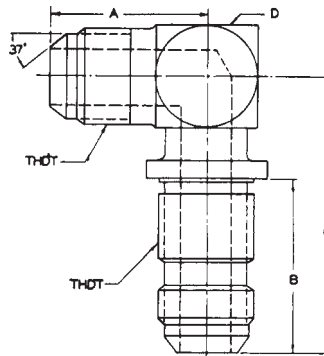

Part Number	Tube O.D.	JIC Male	A	B	C	D Min.
2701-4	1/4	7/16 - 20	61/64	1-7/64	1-37/64	7/16
2701-5	5/16	1/2 - 20	1-1/64	1-7/64	1-39/64	1/2
2701-6	3/8	9/16 - 18	1-5/64	1-3/16	1-51/64	9/16
2701-8	1/2	3/4 - 16	1-11/32	1-3/8	2-3/32	3/4
2701-10	5/8	7/8 - 14	1-35/64	1-33/64	2-3/8	7/8
2701-12	3/4	1-1/16 - 12	1-49/64	1-11/16	2-21/32	1-1/16
2701-16	1	1-5/16 - 12	1-59/64	1-11/64	2-25/32	1-5/16
2701-20	1-1/4	1-5/8 - 12	2-5/32	1-47/64	3-7/64	1-5/8

2702 BULKHEAD 45° ELBOW

*

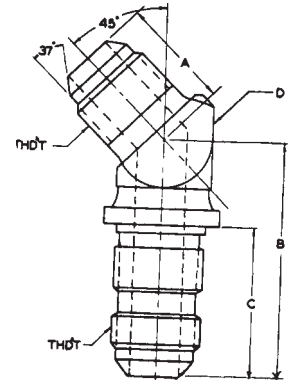

Part Number	Tube O.D.	JIC Male	A	B	C	D Min.
2702-4	1/4	7/16 - 20	45/64	1-17/32	1-7/64	7/16
2702-5	5/16	1/2 - 20	3/4	1-17/32	1-7/64	1/2
2702-6	3/8	9/16 - 18	13/16	1-9/64	1-3/16	9/16
2702-8	1/2	3/4 - 16	31/32	1-15/16	1-3/8	3/4
2702-10	5/8	7/8 - 14	1-3/32	2-11/64	1-33/64	7/8
2702-12	3/4	1-1/16 - 12	1-17/64	2-7/16	1-11/16	1-1/16
2702-16	1	1-5/16 - 12	1-29/64	2-9/16	1-11/16	1-5/16

2701-LN BULKHEAD 90° TUBE UNION LOCK NUT

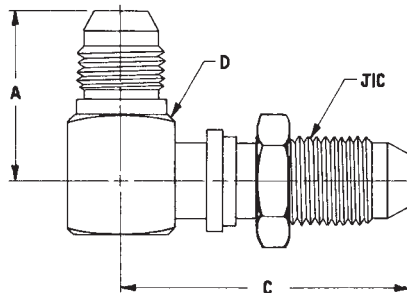

Part Number	Tube O.D.	JIC Male	A	C	D
2701-4-LN	1/4	7/16 - 20	-	-	-
2701-5-LN	5/16	1/2 - 20	-	-	-
2701-6-LN	3/8	9/16 - 18	-	-	-
2701-8-LN	1/2	3/4 - 16	-	-	-
2701-10-LN	5/8	7/8 - 14	-	-	-
2701-12-LN	3/4	1-1/16 - 12	-	-	-
2701-16-LN	1	1-5/16 - 12	-	-	-
2701-20-LN	1-1/4	1-5/8 - 12	-	-	-

2702-LN BULKHEAD 45° TUBE ELBOW LOCK NUT

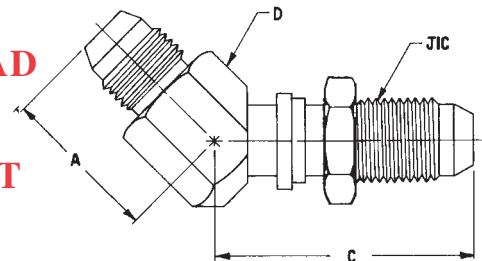

Part Number	Tube O.D.	JIC Male	A	C	D
2702-4-LN	1/4	7/16 - 20	-	-	-
2702-5-LN	5/16	1/2 - 20	-	-	-
2702-6-LN	3/8	9/16 - 18	-	-	-
2702-8-LN	1/2	3/4 - 16	-	-	-
2702-10-LN	5/8	7/8 - 14	-	-	-
2702-12-LN	3/4	1-1/16 - 12	-	-	-
2702-16-LN	1	1-5/16 - 12	-	-	-



* Available in 316
Stainless Steel

Hydraulic Adapters & Tube Fittings

2703 BULK HEAD TEE

*

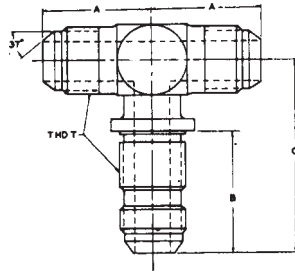

Part Number	Tube O.D.	JIC Male	A	B	C
2703-4	1/4	7/16 - 20	61/64	1-7/64	1-37/64
2703-5	5/16	1/2 - 20	1-1/64	1-7/64	1-39/64
2703-6	3/8	9/16 - 18	1-5/64	1-3/16	1-51/64
2703-8	1/2	3/4 - 16	1-11/32	1-3/8	2-3/32
2703-10	5/8	7/8 - 14	1-35/64	1-33/64	1-3/8
2703-12	3/4	1-1/16 - 12	1-49/64	1-11/16	2-21/32
2703-16	1	1-5/16 - 12	1-59/64	1-11/16	2-25/32

2704-LN BULKHEAD TUBE TEE LOCK NUT

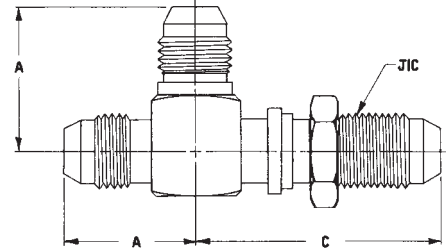

Part Number	Tube O.D.	JIC Male	A	C
2704-4-LN	1/4	7/16 - 20	-	-
2704-6-LN	3/8	9/16 - 18	-	-
2704-8-LN	1/2	3/4 - 16	-	-
2704-10-LN	5/8	7/8 - 14	-	-
2704-12-LN	3/4	1-1/16 - 12	-	-
2704-16-LN	1	1-5/16 - 12	-	-

2703-LN BULKHEAD TUBE TEE LOCK NUT

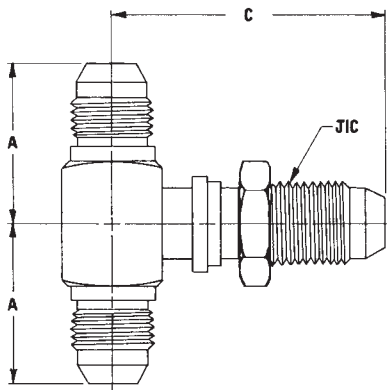

Part Number	Tube O.D.	JIC Male	A	C
2703-4-LN	1/4	7/16 - 20	-	-
2703-6-LN	3/8	9/16 - 18	-	-
2703-8-LN	1/2	3/4 - 16	-	-
2703-10-LN	5/8	7/8 - 14	-	-
2703-12-LN	3/4	1-1/16 - 12	-	-

2705 BULKHEAD CONNECTOR

*

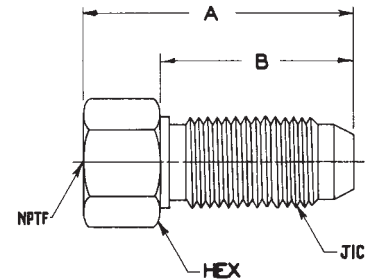

Part Number	Tube O.D.	NPTF Female	JIC Male	A	B	Hex
2705-2-4	1/4	1/8	7/16 - 20	-	-	-
2705-4-4	1/4	1/4	7/16 - 20	-	-	-
2705-4-6	3/8	1/4	9/16 - 18	-	-	-
2705-6-6	3/8	3/8	9/16 - 18	-	-	-
2705-6-8	1/2	3/8	3/4 - 16	-	-	-
2705-8-8	1/2	1/2	3/4 - 16	-	-	-
2705-8-10	5/8	1/2	7/8 - 14	-	-	-
2705-12-6	3/8	3/4	9/16 - 18	-	-	-
2705-12-12	3/4	3/4	1-1/16 - 12	-	-	-
2705-12-14	7/8	3/4	1-3/16 - 12	-	-	-
2705-16-16	1	1	1-5/16 - 12	-	-	-
2705-20-20	1-1/4	1-1/4	1-5/8 - 12	-	-	-

2704 BULKHEAD TUBE TEE

*

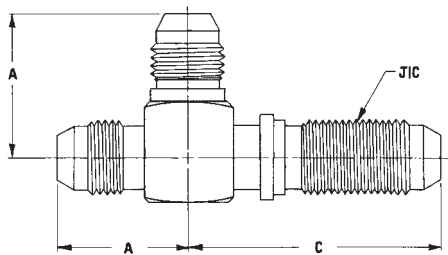

Part Number	Tube O.D.	JIC Male	A	C
2704-4	1/4	7/16 - 20	-	-
2704-5	5/16	1/2 - 20	-	-
2704-6	3/8	9/16 - 18	-	-
2704-8	1/2	3/4 - 16	-	-
2704-10	5/8	7/8 - 14	-	-
2704-12	3/4	1-1/16 - 12	-	-
2704-16	1	1-5/16 - 12	-	-

2705-LN BULKHEAD CONNECTOR LOCK NUT

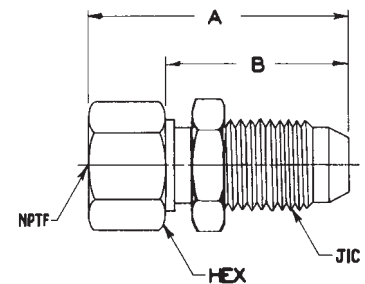

Part Number	Tube O.D.	NPTF Female	JIC Male	A	B	Hex
2705-2-4-LN	1/4	1/8	7/16 - 20	-	-	-
2705-4-6-LN	3/8	1/4	9/16 - 18	-	-	-
2705-6-8-LN	1/2	3/8	3/4 - 16	-	-	-
2705-8-12-LN	3/4	1/2	1-1/16 - 12	-	-	-
2705-12-LN	3/4	3/4	1-1/16 - 12	-	-	-
2705-16-LN	1	1	1-5/16 - 12	-	-	-

Hydraulic Adapters & Tube Fittings

* Available in 316
Stainless Steel



2706 BULKHEAD X NPTF MALE CONNECTOR

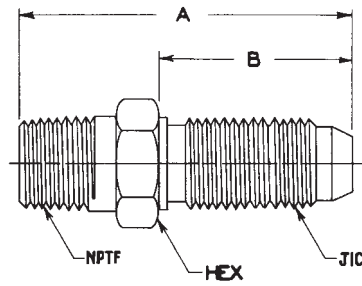

Part Number	Tube O.D.	NPTF Male	JIC Male	A	B	Hex
2706-2-4	1/4	1/8	7/16 - 20	-	-	-
2706-4-4	1/4	1/4	7/16 - 20	-	-	-
2706-4-6	3/8	1/4	9/16 - 18	-	-	-
2706-6-6	3/8	3/8	9/16 - 18	-	-	-
2706-6-8	1/2	3/8	3/4 - 16	-	-	-
2706-8-8	1/2	1/2	3/4 - 16	-	-	-
2706-8-10	5/8	1/2	7/8 - 14	-	-	-
2706-8-12	3/4	1/2	1-1/16 - 12	-	-	-
2706-12-12	3/4	3/4	1-1/16 - 12	-	-	-
2706-16-16	1	1	1-5/16 - 12	-	-	-
2706-20-20	1-1/4	1-1/4	1-5/8 - 12	-	-	-
2706-24-24	1-1/2	1-1/2	1-7/8 - 12	-	-	-
2706-32-32	2	2	2-1/2 - 12	-	-	-

2706-LN BULKHEAD X NPTF MALE CONNECTOR LOCK NUT

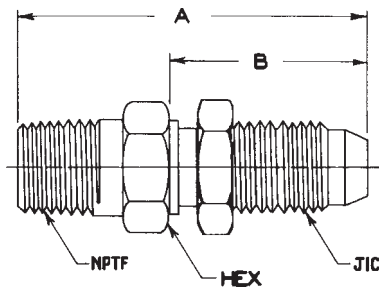

Part Number	Tube O.D.	NPTF Male	JIC Male	A	B	Hex
2706-2-4-LN	1/4	1/8	7/16 - 20	-	-	-
2706-4-LN	1/4	1/4	7/16 - 20	-	-	-
2706-4-6-LN	3/8	1/4	9/16 - 18	-	-	-
2706-6-8-LN	1/2	3/8	3/4 - 16	-	-	-
2706-8-10-LN	5/8	1/2	7/8 - 14	-	-	-
2706-12-LN	3/4	3/4	1-1/16 - 12	-	-	-
2706-16-LN	1	1	1-5/16 - 12	-	-	-

4000 ORB O-RING

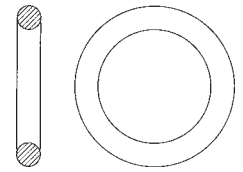

Part Number	ORB O-Ring
4000-2	5/16-24
4000-3	3/8-24
4000-4	7/16-20
4000-5	1/2-20
4000-6	9/16-18
4000-8	3/4-16
4000-10	7/8-14
4000-12	1-1/16-12
4000-14	1-3/16-12
4000-16	1-5/16-12
4000-20	1-5/8-12
4000-24	1-7/8-12
4000-32	2-1/2-12

4001-VOR ORB O-RING VITON

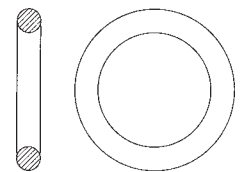

Part Number	ORB O-Ring
4001-4-VOR	7/16-20
4001-5-VOR	1/2-20
4001-6-VOR	9/16-18
4001-8-VOR	3/4-16
4001-10-VOR	7/8-14
4001-12-VOR	1-1/16-12
4001-14-VOR	1-3/16-12
4001-16-VOR	1-5/16-12
4001-20-VOR	1-5/8-12
4001-24-VOR	1-7/8-12
4001-32-VOR	2-1/2-12



* Available in 316
Stainless Steel

Hydraulic Adapters & Tube Fittings

4404 STRAIGHT BARB HOSE STEM

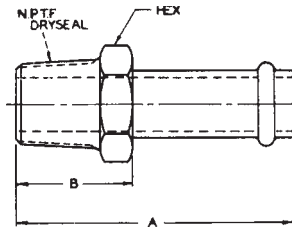

Part Number	Tube O.D.	NPTF Male	Hex	A	B
4404-4-2	1/4	1/8	7/16	2-5/64	37/64
4404-5-2	5/16	1/8	7/16	2-5/64	37/64
4404-6-4	3/8	1/4	5/8	2-11/32	27/32
4404-6-6	3/8	3/8	-	-	-
4404-8-6	1/2	3/8	3/4	2-3/8	7/8
4404-10-6	5/8	3/8	-	-	-
4404-10-8	5/8	1/2	15/16	2-37/64	1-5/64
4404-12-8	3/4	1/2	-	-	-
4404-12-12	3/4	3/4	1-1/8	2-5/8	1-1/8
4404-16-12	1	3/4	-	-	-
4404-16-16	1	1	1-1/4	2-27/32	1-11/32
4404-20-20	1-1/4	1-1/4	1-3/4	2-57/64	1-25/64
4404-24-20	1-1/2	1-1/2	-	-	-
4404-24-24	1-1/2	1-1/2	2	2-15/16	1-7/16
4404-32-32	2	2	2-1/2	2-15/16	1-7/16

4503 45° BARB HOSE STEM

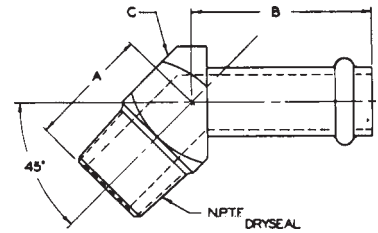

Part Number	Tube O.D.	NPTF Male	A	B	C
4503-4-2	1/4	1/8	5/8	1-9/16	1/2
4503-5-2	5/16	1/8	5/8	1-9/16	1/2
4503-6-4	3/8	1/4	27/32	1-5/8	5/8
4503-8-6	1/2	3/8	15/16	1-11/16	13/16
4503-8-8	1/2	1/2	-	-	-
4503-10-6	5/8	3/8	1-5/32	1-23/32	15/16
4503-10-8	5/8	1/2	-	-	-
4503-12-8	3/4	1/2	-	-	-
4503-12-12	3/4	3/4	1-3/16	1-23/32	1-1/8
4503-16-12	1	3/4	-	-	-
4503-16-16	1	1	1-15/32	1-3/4	1-3/8
4503-20-20	1-1/4	1-1/4	1-21/32	1-13/16	1-3/4
4503-24-24	1-1/2	1-1/2	1-3/4	1-7/8	2
4503-32-32	2	2	2-3/32	2	2-1/2

4501 90° BARB HOSE STEM

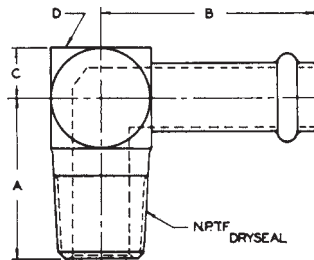

Part Number	Tube O.D.	NPTF Male	A	B	C	D
4501-4-2	1/4	1/8	25/32	1-3/4	1/4	1/2
4501-4-4	1/4	1/4	-	-	-	-
4501-6-4	3/8	1/4	1-1/16	1-13/16	5/16	5/8
4501-6-6	3/8	3/8	-	-	-	-
4501-8-6	1/2	3/8	1-3/16	1-29/32	13/32	13/16
4501-8-8	1/2	1/2	-	-	-	-
4501-8-12	1/2	3/4	-	-	-	-
4501-10-6	5/8	3/8	-	-	-	-
4501-10-8	5/8	1/2	1-7/16	1-31/32	15/32	15/16
4501-12-6	3/4	3/8	-	-	-	-
4501-12-8	3/4	1/2	-	-	-	-
4501-12-12	3/4	3/4	1-19/32	2-1/16	9/16	1-1/8
4501-12-16	3/4	1	-	-	-	-
4501-16-12	1	3/4	-	-	-	-
4501-16-16	1	1	1-31/32	2-3/16	11/16	1-3/8
4501-20-16	1-1/4	1	-	-	-	-
4501-20-20	1-1/4	1-1/4	2-3/8	2-3/8	7/8	1-3/4
4501-24-24	1-1/2	1-1/2	2-5/8	2-1/2	1	2
4501-32-32	2	2	3	2-3/4	1-1/4	2-1/2

4601 90° BARB HOSE STEM

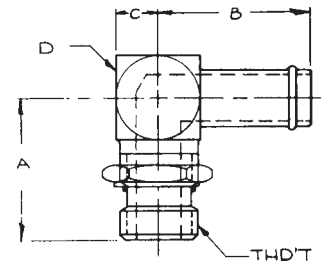

Part Number	Tube O.D.	ORB Male	A	B	C	D
4601-4	1/4	7/16 - 20	1-1/64	1-3/4	1/4	1/3
4601-6	3/8	9/16 - 18	1-15/64	1-13/16	5/16	5/8
4601-8	1/2	3/4 - 16	1-7/16	1-29/32	13/32	13/16
4601-10-6	5/8	9/16 - 18	1-23/64	1-28/32	3/8	3/4
4601-10	5/8	7/8 - 14	1-11/16	1-31/32	15/32	15/16
4601-12-8	3/4	3/4 - 16	-	-	-	-
4601-12-10	3/4	7/8 - 14	-	-	-	-
4601-12	3/4	1-1/16 - 12	1-59/64	2-1/16	9/16	1-1/8
4601-16-12	1	1-1/16 - 12	-	-	-	-
4601-16-14	1	1-3/16 - 12	-	-	-	-
4601-16	1	1-5/16 - 12	2-1/32	2-3/16	11/16	1-3/8
4601-16-20	1	1-5/8 - 12	-	-	-	-
4601-20-16	1-1/4	1-5/16 - 12	-	-	-	-
4601-20	1-1/4	1-5/8 - 12	2-15/64	2-3/8	7/8	1-3/4
4601-20-24	1-1/4	1-7/8 - 12	-	-	-	-
4601-24	1-1/2	1-7/8 - 12	2-3/8	2-1/2	1	2
4601-32	2	2-1/2 - 12	2-7/8	2-13/16	1-5/16	2-5/8

Hydraulic Adapters & Tube Fittings

* Available in 316
Stainless Steel



4603 45° BARB HOSE STEM

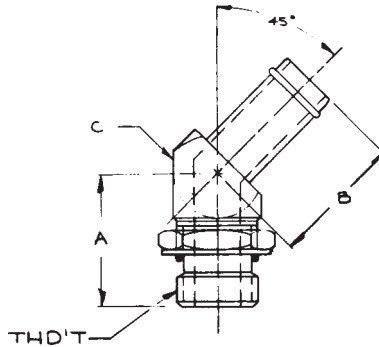

Part Number	Tube O.D.	ORB Male	B	A	C
4603-4	1/4	7/16 - 20	1-9/16	1-1/32	1/2
4603-5	5/16	1/2 - 20	1-39/64	1-1/32	9/16
4603-6	3/8	9/16 - 18	1-19/32	1-1/8	5/8
4603-8	1/2	3/4 - 16	1-5/8	1-9/32	13/16
4603-10	5/8	7/8 - 14	1-39/64	1-1/2	15/16
4603-12-8	3/4	3/4 - 16	-	-	-
4603-12	3/4	1-1/16 - 12	1-45/64	1-23/32	1-1/8
4603-16-12	1	1-1/16 - 12	-	-	-
4603-16	1	1-5/16 - 12	1-55/64	1-27/32	1-3/8
4603-20	1-1/4	1-5/8 - 12	1-59/64	1-57/64	1-3/4
4603-24	1-1/2	1-7/8 - 12	1-31/32	1-57/64	2
4603-32	2	2-1/2 - 12	2-9/64	1-27/32	2-5/8

5000 FEMALE PIPE COUPLING

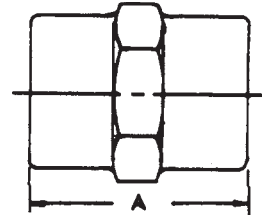

*

Part Number	NPTF Female	NPTF Female	A	Hex
5000-2-2	1/8	1/8	7/8	9/16
5000-4-2	1/4	1/8	-	-
5000-4-4	1/4	1/4	1-1/8	3/4
5000-6-2	3/8	1/8	-	-
5000-6-4	3/8	1/4	-	-
5000-6-6	3/8	3/8	1-7/16	15/16
5000-8-4	1/2	1/4	-	-
5000-8-6	1/2	3/8	-	-
5000-8-8	1/2	1/2	1-5/8	1-1/8
5000-12-8	3/4	1/2	-	-
5000-12-12	3/4	3/4	2	1-3/8
5000-16-12	1	3/4	-	-
5000-16-16	1	1	2-1/8	1-5/8
5000-20-20	1-1/4	1-1/4	2-5/16	2
5000-24-20	1-1/2	1-1/4	-	-
5000-24-24	1-1/2	1-1/2	2-1/2	2-3/8
5000-32-32	2	2	-	-

4604 STRAIGHT BARB HOSE STEM

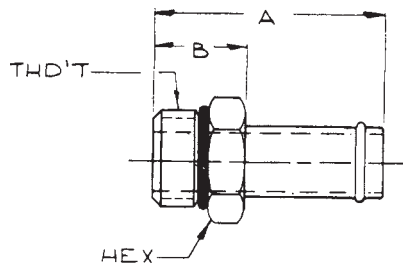

Part Number	Tube O.D.	ORB Male	Hex	A	B
4604-4	1/4	7/16 - 20	9/16	2-7/64	39/64
4604-5	5/16	1/2 - 20	5/8	2-7/64	39/64
4604-6	3/8	9/16 - 18	11/16	2-3/16	11/16
4604-8	1/2	3/4 - 16	7/8	2-1/4	3/4
4604-10	5/8	7/8 - 14	1	2-5/16	13/16
4604-12-8	3/4	3/4 - 16	-	-	-
4604-12-12	3/4	1-1/16 - 12	-	-	-
4604-16-12	1	1-1/16 - 12	-	-	-
4604-16	1	1-5/16 - 12	1-1/2	2-1/2	1
4604-16-20	1	1-5/8 - 12	-	-	-
4604-20-16	1-1/4	1-5/16 - 12	-	-	-
4604-20	1-1/4	1-5/8 - 12	1-7/8	2-1/2	1
4604-24-20	1-1/2	1-5/8 - 12	-	-	-
4604-24	1-1/2	1-7/8 - 12	2-1/8	2-1/2	1
4604-32	2	2-1/2 - 12	2-3/4	2-1/2	1

5404 MALE PIPE COUPLING

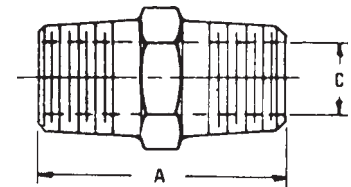

*

Part Number	NPTF Male	NPTF Male	A	Hex	C
5404-2-2	1/8	1/8	15/16	7/16	3/16
5404-4-2	1/4	1/8	-	-	-
5404-4-4	1/4	1/4	1-3/8	9/16	9/32
5404-6-2	3/8	1/8	-	-	-
5404-6-4	3/8	1/4	-	-	-
5404-6-6	3/8	3/8	1-17/32	3/4	13/32
5404-8-4	1/2	1/4	-	-	-
5404-8-6	1/2	3/8	-	-	-
5404-8-8	1/2	1/2	1-13/16	7/8	17/32
5404-12-6	3/4	3/8	-	-	-
5404-12-8	3/4	1/2	-	-	-
5404-12-12	3/4	3/4	1-7/8	1-1/8	23/32
5404-16-12	1	3/4	-	-	-
5404-16-16	1	1	2-7/32	1-3/8	15/16
5404-20-12	1-1/4	3/4	-	-	-
5404-20-16	1-1/4	1	-	-	-
5404-20-20	1-1/4	1-1/4	2-13/32	1-3/4	1-1/4
5404-24-12	1-1/2	3/4	-	-	-
5404-24-16	1-1/2	1	-	-	-
5404-24-24	1-1/2	1-1/2	2-19/32	2	1-1/2
5404-32-32	2	2	-	-	-



* Available in 316
Stainless Steel

Hydraulic Adapters & Tube Fittings

5404-N NPTF MALE NIPPLE

*

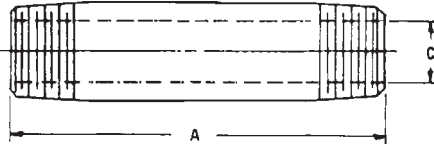

Part Number	NPTF Male	A	
5404-N-2-CLS	1/8	—	
5404-N-2-2	1/8	2.00	
5404-N-2-2.5	1/8	2.50	
5404-N-2-3	1/8	3.00	
5404-N-2-4	1/8	4.00	
5404-N-4-CLS	1/4	—	
5404-N-4-2	1/4	2.00	
5404-N-4-3	1/4	3.00	
5404-N-4-4	1/4	4.00	
5404-N-6-CLS	3/8	—	
5404-N-6-2	3/8	2.00	
5404-N-6-2.5	3/8	2.50	
5404-N-6-3	3/8	3.00	
5404-N-6-4	3/8	4.00	
5404-N-6-6	3/8	6.00	
5404-N-8-CLS	1/2	—	
5404-N-8-2	1/2	2.00	
5404-N-8-2.5	1/2	2.50	
5404-N-8-3	1/2	3.00	
5404-N-8-4	1/2	4.00	
5404-N-12-CLS	3/4	—	
5404-N-12-2	3/4	2.00	
5404-N-12-3	3/4	3.00	
5404-N-12-4	3/4	4.00	
5404-N-16-CLS	1	—	
5404-N-16-3	1	3.00	
5404-N-20-CLS	1-1/4	—	
5404-N-24-CLS	1-1/2	—	

5406 PIPE-REDUCER- BUSHING

*

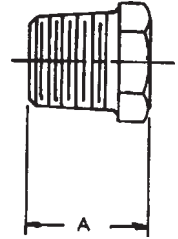

Part Number	NPTF Male	NPTF Female	A	Hex
5406-4-2	1/4	1/8	25/32	9/16
5406-6-2	3/8	1/8	-	-
5406-6-4	3/8	1/4	25/32	3/4
5406-8-2	1/2	1/8	-	-
5406-8-4	1/2	1/4	-	-
5406-8-6	1/2	3/8	1-1/32	7/8
5406-12-4	3/4	1/4	-	-
5406-12-6	3/4	3/8	-	-
5406-12-8	3/4	1/2	1-1/16	1-1/8
5406-16-4	1	1/4	-	-
5406-16-6	1	3/8	-	-
5406-16-8	1	1/2	-	-
5406-16-12	1	3/4	1-1/4	1-3/8
5406-20-8	1-1/4	1/2	-	-
5406-20-12	1-1/4	3/4	-	-
5406-20-16	1-1/4	1	1-9/32	1-3/4
5406-24-12	1-1/2	3/4	-	-
5406-24-16	1-1/2	1	-	-
5406-24-20	1-1/2	1-1/4	1-5/16	2
5406-32-16	2	1	-	-
5406-32-20	2	1-1/4	-	-
5406-32-24	2	1-1/2	1-3/8	2-1/2

5405 PIPE EXPANSION COUPLING

*

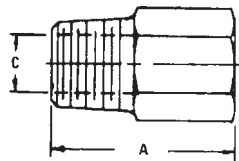

Part Number	NPTF Male	NPTF Female	A	Hex	C
5405-2-2	1/8	1/8	1	9/16	9/32
5405-2-4	1/8	1/4	-	-	-
5405-2-8	1/8	1/2	-	-	-
5405-4-2	1/4	1/8	-	-	-
5405-4-4	1/4	1/4	-	-	-
5405-4-6	1/4	3/8	-	-	-
5405-4-8	1/4	1/2	-	-	-
5405-4-12	1/4	3/4	-	-	-
5405-6-4	3/8	1/4	1-5/16	3/4	13/32
5405-6-6	3/8	3/8	-	-	-
5405-6-8	3/8	1/2	-	-	-
5405-8-4	1/2	1/4	-	-	-
5405-8-6	1/2	3/8	1-11/16	7/8	17/32
5405-8-8	1/2	1/2	-	-	-
5405-8-12	1/2	3/4	-	-	-
5405-8-16	1/2	1	-	-	-
5405-12-8	3/4	1/2	1-13/16	1-1/8	11/16
5405-12-12	3/4	3/4	-	-	-
5405-12-16	3/4	1	-	-	-
5405-16-12	1	3/4	1-15/16	1-3/8	57/64
5405-16-16	1	1	-	-	-
5405-16-20	1	1-1/4	-	-	-
5405-20-16	1-1/4	1	2-1/8	1-3/4	1-1/8
5405-20-20	1-1/4	1-1/4	-	-	-
5405-20-24	1-1/4	1-1/2	-	-	-
5405-24-20	1-1/2	1-1/4	2-1/4	2	1-15/32
5405-24-24	1-1/2	1-1/2	-	-	-
5405-24-32	1-1/2	2	-	-	-

5406-C HEAVY DUTY FEMALE PIPE CAP NUT

*

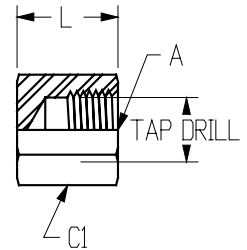

Part Number	A NPTF	L	C1	Tap Drill
5406-C-2	1/8 - 27	.69	.56	.33
5406-C-4	1/4 - 18	.92	.75	.43
5406-C-6	3/8 - 18	.97	.88	.57
5406-C-8	1/2 - 14	1.23	1.13	.70
5406-C-12	3/4 - 14	1.31	1.38	.91
5406-C-16	1 - 11-1/2	1.61	1.63	1.14

Hydraulic Adapters & Tube Fittings

* Available in 316 Stainless Steel



5406-P PIPE PLUG

*

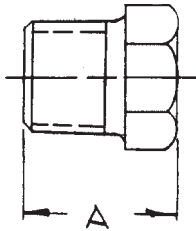

Part Number	NPTF Male	A	Hex
5406-2P	1/8	9/16	7/16
5406-4P	1/4	25/32	9/16
5406-6P	3/8	25/32	3/4
5406-8P	1/2	1	7/8
5406-12P	3/4	1-1/16	1-1/8
5406-16P	1	1-1/4	1-3/8
5406-20P	1-1/4	1-9/32	1-3/4
5406-24P	1-1/2	1-5/16	2
5406-32P	2	1-3/8	2-1/2

5501 45° NPTF MALE ELBOW

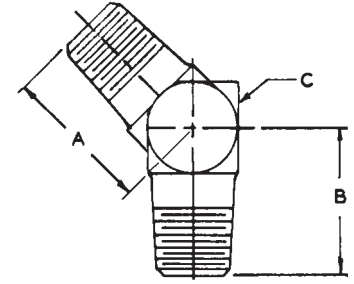

Part Number	NPTF Male	NPTF Male
5501-2-2	1/8	1/8
5501-4-4	1/4	1/4
5501-6-6	3/8	3/8
5501-8-8	1/2	1/2
5501-12-12	3/4	3/4
5501-16-16	1	1

5409 HEXAGON SOCKET MALE PIPE PLUG

*

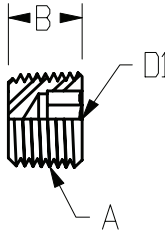

Part Number	A NPTF	B	D1
5409-2	1/8 - 27	.30	.19
5409-6	3/8 - 18	.46	.31
5409-4	1/4 - 18	.46	.25
5409-8	1/2 - 14	.61	.38
5409-12	3/4 - 14	.62	.56
5409-16	1 - 11-1/2	.77	.63
5409-20	1-1/4 - 11-1/2	.80	.63

5502 STREET ELBOW 90°

*

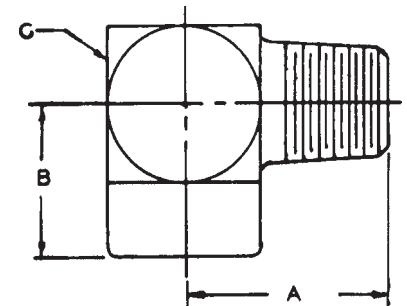

Part Number	NPTF Male	NPTF Female	A	B	C
5502-2-2	1/8	1/8	13/16	21/32	5/8
5502-2-4	1/8	1/4	-	-	-
5502-4-2	1/4	1/8	-	-	-
5502-4-4	1/4	1/4	1-1/4	7/8	3/4
5502-4-6	1/4	3/8	-	-	-
5502-6-4	3/8	1/4	-	-	-
5502-6-6	3/8	3/8	1-1/4	15/16	7/8
5502-6-8	3/8	1/2	-	-	-
5502-8-4	1/2	1/4	-	-	-
5502-8-6	1/2	3/8	-	-	-
5502-8-8	1/2	1/2	1-1/2	1-1/8	1-1/8
5502-8-12	1/2	3/4	-	-	-
5502-12-8	3/4	1/2	-	-	-
5502-12-12	3/4	3/4	1-5/8	1-5/16	1-3/8
5502-16-12	1	3/4	-	-	-
5502-16-16	1	1	2-1/16	1-5/8	1-5/8
5502-20-20	1-1/4	1-1/4	2-7/16	1-23/32	2
5502-24-24	1-1/2	1-1/2	2-3/4	2-1/16	2-3/8
5502-32-32	2	2	3	2-3/8	2-7/8

5500 MALE PIPE ELBOW 90°

*

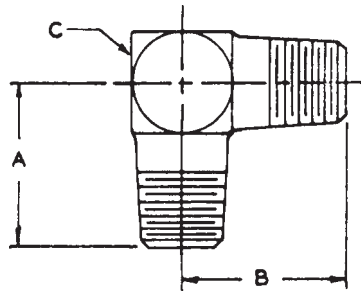

Part Number	NPTF Male	NPTF Male	A	B	C
5500-2-2	1/8	1/8	3/4	3/4	1/2
5500-4-2	1/4	1/8	-	-	-
5500-4-4	1/4	1/4	1-3/32	1-3/32	5/8
5500-6-4	3/8	1/4	-	-	-
5500-6-6	3/8	3/8	1-7/32	1-7/32	3/4
5500-8-6	1/2	3/8	-	-	-
5500-8-8	1/2	1/2	1-15/32	1-15/32	15/16
5500-12-8	3/4	1/2	-	-	-
5500-12-12	3/4	3/4	-	-	-
5500-16-12	1	3/4	-	-	-
5500-16-16	1	1	1-31/32	1-31/32	1-3/8
5500-20-20	1-1/4	1-1/4	2-3/8	2-3/8	1-3/4
5500-24-24	1-1/2	1-1/2	2-5/8	2-5/8	2
5500-32-32	2	2	-	-	-



* Available in 316
Stainless Steel

Hydraulic Adapters & Tube Fittings

5503 STREET ELBOW 45°

*

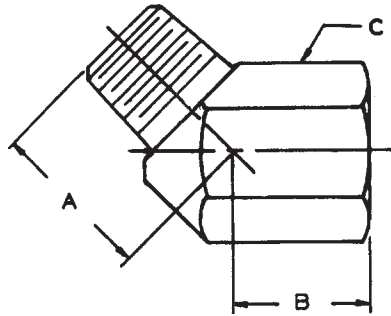

Part Number	NPTF Male	NPTF Female	A	B	C Hex
5503-2	1/8	1/8	5/8	7/16	5/8
5503-4	1/4	1/4	15/16	9/16	11/16
5503-6	3/8	3/8	1-1/8	3/4	7/8
5503-8	1/2	1/2	1-3/16	1	1-1/8
5503-12	3/4	3/4	1-3/8	1-1/4	1-5/16
5503-16	1	1	1-5/8	1-3/8	1-5/8
5503-20	1-1/4	1-1/4	-	-	-
5503-24	1-1/2	1-1/2	-	-	-

5504 FEMALE PIPE ELBOW 90°

*

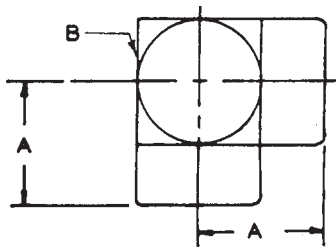

Part Number	NPTF Female	NPTF Female	A	B
5504-2-2	1/8	1/8	11/16	5/8
5504-4-2	1/4	1/8	-	-
5504-4-4	1/4	1/4	13/16	3/4
5504-6-4	3/8	1/4	-	-
5504-6-6	3/8	3/8	15/16	7/8
5504-8-6	1/2	3/8	-	-
5504-8-8	1/2	1/2	1-1/8	1-1/8
5504-12-8	3/4	1/2	-	-
5504-12-12	3/4	3/4	1-5/16	1-3/8
5504-16-16	1	1	1-5/8	1-5/8
5504-20-20	1-1/4	1-1/4	1-3/4	2
5504-24-24	1-1/2	1-1/2	2	2-3/8
5504-32-32	2	2	-	-

5505 45° NPTF FEMALE ELBOW

*

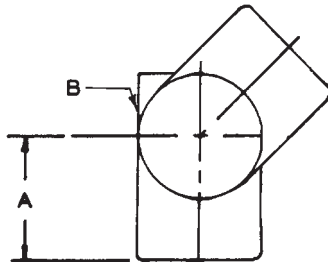

Part Number	NPTF Female	NPTF Female
5505-2-2	1/8	1/8
5505-4-4	1/4	1/4
5505-6-6	3/8	3/8
5505-8-8	1/2	1/2
5505-12-12	3/4	3/4
5505-16-16	1	1

5600 NPTF MALE TEE

*

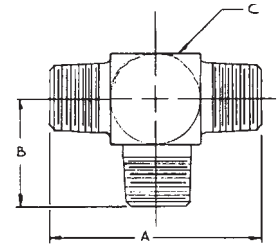

Part Number	NPTF Male	A	B	C
5600-2	1/8	-	-	-
5600-4	1/4	-	-	-
5600-6	3/8	-	-	-
5600-8	1/2	-	-	-
5600-12	3/4	-	-	-
5600-16	1	-	-	-
5600-20	1-1/4	-	-	-

5601 NPTF MALE X NPTF MALE X NPTF FEMALE TEE

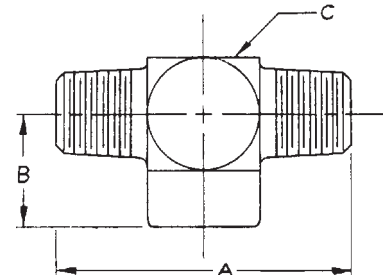

Part Number	NPTF Male	NPTF Male	NPTF Female	A	B	C
5601-2	1/8	1/8	1/8	-	-	-
5601-4	1/4	1/4	1/4	-	-	-
5601-6	3/8	3/8	3/8	-	-	-
5601-8	1/2	1/2	1/2	-	-	-
5601-12	3/4	3/4	3/4	-	-	-
5601-16	1	1	1	-	-	-
5601-20	1-1/4	1-1/4	1-1/4	-	-	-
5601-24	1-1/2	1-1/2	1-1/2	-	-	-

5602 SERVICE TEE

*

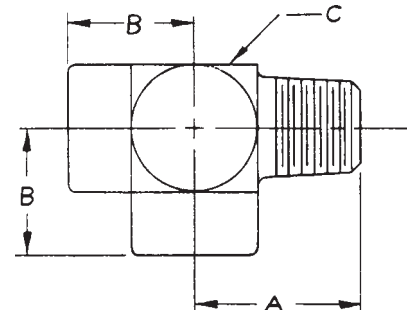

Part Number	NPTF Male	NPTF Female	NPTF Female	A	B	C
5602-2	1/8	1/8	1/8	13/16	21/32	5/8
5602-4	1/4	1/4	1/4	1-1/4	7/8	3/4
5602-6	3/8	3/8	3/8	1-1/4	15/16	7/8
5602-8	1/2	1/2	1/2	1-1/2	1-1/8	1-1/8
5602-12	3/4	3/4	3/4	1-5/8	1-5/16	1-3/8
5602-16	1	1	1	2-1/16	1-5/8	1-5/8
5602-20	1-1/4	1-1/4	1-1/4	2-7/16	1-23/32	2
5602-24	1-1/2	1-1/2	1-1/2	2-3/4	2-1/16	2-3/8
5602-32	2	2	2	3	2-3/8	2-7/8

Hydraulic Adapters & Tube Fittings

* Available in 316 Stainless Steel



5603 MALE FEMALE RUN TEE

*

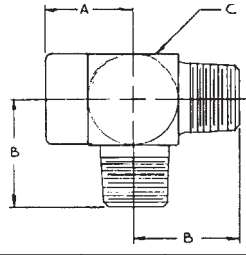

Part Number	NPTF Male	NPTF Female	NPTF Male	A	B	C
5603-2	1/8	1/8	1/8	21/32	13/16	5/8
5603-4	1/4	1/4	1/4	7/8	1-1/4	3/4
5603-6	3/8	3/8	3/8	15/16	1-1/4	7/8
5603-8	1/2	1/2	1/2	1-1/8	1-1/2	1-1/8
5603-12	3/4	3/4	3/4	1-5/16	1-5/8	1-3/8
5603-16	1	1	1	1-5/8	2-1/16	1-5/8
5603-20	1-1/4	1-1/4	1-1/4	1-23/32	2-7/16	2
5603-24	1-1/2	1-1/2	1-1/2	2-1/16	2-3/4	2-3/8

5650 MALE PIPE CROSS

*

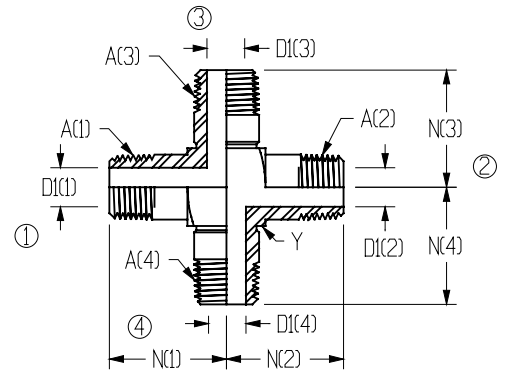

INFORMATION AVAILABLE UPON REQUEST.
CALL CUSTOMER SERVICE FOR DETAILS.

5604 MALE-FEMALE PIPE TEE

*

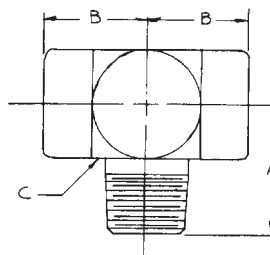

Part Number	NPTF Female	NPTF Female	NPTF Male	A	B	C
5604-2	1/8	1/8	1/8	13/16	21/32	5/8
5604-4	1/4	1/4	1/4	1-1/4	7/8	3/4
5604-6	3/8	3/8	3/8	1-1/4	15/16	7/8
5604-8	1/2	1/2	1/2	1-1/2	1-1/8	1-1/8
5604-12	3/4	3/4	3/4	1-5/8	1-5/16	1-3/8
5604-16	1	1	1	2-1/16	1-5/8	1-5/8
5604-20	1-1/4	1-1/4	1-1/4	2-7/16	1-23/32	2
5604-24	1-1/2	1-1/2	1-1/2	2-3/4	2-1/16	2-3/8

5652 FEMALE PIPE CROSS

*

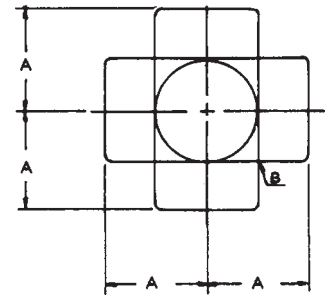

Part Number	NPTF Female	A	B
5652-2	1/8	11/16	5/8
5652-4	1/4	13/16	3/4
5652-6	3/8	15/16	7/8
5652-8	1/2	1-1/8	1-1/8
5652-12	3/4	1-5/16	1-3/8
5652-16	1	1-5/8	1-5/8
5652-20	1-1/4	1-3/4	2
5652-24	1-1/2	2	2-3/8
5652-32	2	-	-

5605 FEMALE PIPE TEE

*

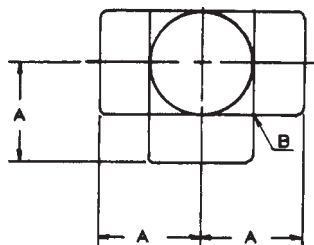

Part Number	NPTF Female	A	B
5605-2	1/8	11/16	5/8
5605-4	1/4	13/16	3/4
5605-6	3/8	15/16	7/8
5605-8	1/2	1-1/8	1-1/8
5605-12	3/4	1-5/16	1-3/8
5605-16	1	1-5/8	1-5/8
5605-20	1-1/4	1-3/4	2
5605-24	1-1/2	2	2-3/8
5605-32	2	-	-

5700 90° NPTF MALE X NPTF MALE SWIVEL

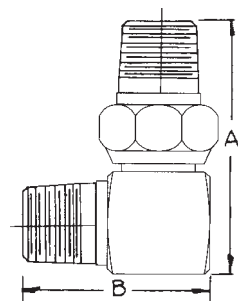

Part Number	NPTF Male	NPTF Male	A	B
5700-4-4	1/4	1/4	-	-
5700-6-6	3/8	3/8	-	-
5700-8-8	1/2	1/2	-	-
5700-12-12	3/4	3/4	-	-



* Available in 316
Stainless Steel

Hydraulic Adapters & Tube Fittings

5702 90° NPTF FEMALE X NPTF MALE SWIVEL

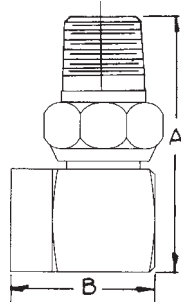

Part Number	NPTF Female	NPTF Male	A	B
5702-4-4	1/4	1/4	-	-
5702-6-6	3/8	3/8	-	-
5702-8-8	1/2	1/2	-	-
5702-12-12	3/4	3/4	-	-

6400 STRAIGHT CONNECTOR

*

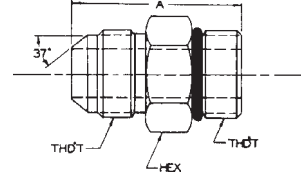

Part Number	Tube O.D.	JIC Male	ORB Male	A	Hex
6400-2-2	1/8	5/16 - 24	5/16 - 24	-	-
6400-3-2	3/16	3/8 - 24	5/16 - 24	-	-
6400-3-3	3/16	3/8 - 24	3/8 - 24	-	-
6400-4-2	1/4	7/16 - 20	5/16 - 24	-	-
6400-4-3	1/4	7/16 - 20	3/8 - 24	-	-
6400-4-4	1/4	7/16 - 20	7/16 - 20	1-1/16	9/16
6400-4-5	1/4	7/16 - 20	1/2 - 20	-	-
6400-4-6	1/4	7/16 - 20	9/16 - 18	-	-
6400-4-8	1/4	7/16 - 20	3/4 - 16	-	-
6400-4-10	1/4	7/16 - 20	7/8 - 14	-	-
6400-4-12	1/4	7/16 - 20	1-1/16 - 12	-	-
6400-5-2	5/16	1/2 - 20	5/16 - 24	-	-
6400-5-4	5/16	1/2 - 20	7/16 - 20	-	-
6400-5-5	5/16	1/2 - 20	1/2 - 20	1-1/16	5/8
6400-5-6	5/16	1/2 - 20	9/16 - 18	-	-
6400-5-8	5/16	1/2 - 20	3/4 - 16	-	-
6400-5-10	5/16	1/2 - 20	7/8 - 14	-	-
6400-6-4	3/8	9/16 - 18	7/16 - 20	-	-
6400-6-5	3/8	9/16 - 18	1/2 - 20	-	-
6400-6-6	3/8	9/16 - 18	9/16 - 18	1-3/16	11/16
6400-6-8	3/8	9/16 - 18	3/4 - 16	-	-
6400-6-10	3/8	9/16 - 18	7/8 - 14	-	-
6400-6-12	3/8	9/16 - 18	1-1/16 - 12	-	-
6400-6-16	3/8	9/16 - 18	1-5/16 - 12	-	-
6400-8-4	1/2	3/4 - 16	7/16 - 20	-	-
6400-8-5	1/2	3/4 - 16	1/2 - 20	-	-
6400-8-6	1/2	3/4 - 16	9/16 - 18	-	-
6400-8-8	1/2	3/4 - 16	3/4 - 16	1-11/32	7/8
6400-8-10	1/2	3/4 - 16	7/8 - 14	-	-
6400-8-12	1/2	3/4 - 16	1-1/16 - 12	-	-
6400-8-14	1/2	3/4 - 16	1-3/16 - 12	-	-
6400-8-16	1/2	3/4 - 16	1-5/16 - 12	-	-
6400-8-20	1/2	3/4 - 16	1-5/8 - 12	-	-
6400-10-6	5/8	7/8 - 14	9/16 - 18	-	-
6400-10-8	5/8	7/8 - 14	3/4 - 16	-	-
6400-10-10	5/8	7/8 - 14	7/8 - 14	1-9/16	1
6400-10-12	5/8	7/8 - 14	1-1/16 - 12	-	-
6400-10-16	5/8	7/8 - 14	1-5/16 - 12	-	-
6400-12-8	3/4	1-1/16 - 12	3/4 - 16	-	-
6400-12-10	3/4	1-1/16 - 12	7/8 - 14	-	-
6400-12-12	3/4	1-1/16 - 12	1-1/16 - 12	1-27/32	1-1/4
6400-12-14	3/4	1-1/16 - 12	1-3/16 - 12	-	-
6400-12-16	3/4	1-1/16 - 12	1-5/16 - 12	-	-
6400-12-20	3/4	1-1/16 - 12	1-5/8 - 12	-	-
6400-14-12	7/8	1-3/16 - 12	1-1/16 - 12	-	-
6400-14-14	7/8	1-3/16 - 12	1-3/16 - 12	1-55/64	1-3/8
6400-14-16	7/8	1-3/16 - 12	1-5/16 - 12	-	-
6400-16-8	1	1-5/16 - 12	3/4 - 16	-	-
6400-16-10	1	1-5/16 - 12	7/8 - 14	-	-
6400-16-12	1	1-5/16 - 12	1-1/16 - 12	-	-
6400-16-14	1	1-5/16 - 12	1-3/16 - 12	-	-
6400-16-16	1	1-5/16 - 12	1-5/16 - 12	1-7/8	1-1/2
6400-16-20	1	1-5/16 - 12	1-5/8 - 12	-	-
6400-20-12	1-1/4	1-5/8 - 12	1-1/16 - 12	-	-
6400-20-16	1-1/4	1-5/8 - 12	1-5/16 - 12	-	-
6400-20-20	1-1/4	1-5/8 - 12	1-5/8 - 12	1-59/64	1-7/8
6400-20-24	1-1/4	1-5/8 - 12	1-7/8 - 12	-	-
6400-24-20	1-1/2	1-7/8 - 12	1-5/8 - 12	-	-
6400-24-24	1-1/2	1-7/8 - 12	1-7/8 - 12	2-3/64	2-1/8
6400-24-32	1-1/2	1-7/8 - 12	2-1/2 - 12	-	-
6400-32-24	2	2-1/2 - 12	1-7/8 - 12	-	-
6400-32-32	2	2-1/2 - 12	2-1/2 - 12	2-19/64	2-3/4

6000 STEEL BACKUP WASHER



Part Number	ORB Washer
6000-2	5/16 - 24
6000-3	3/8 - 24
6000-4	7/16 - 20
6000-5	1/2 - 20
6000-6	9/16 - 18
6000-8	3/4 - 16
6000-10	7/8 - 14
6000-12	1-1/16 - 12
6000-14	1-1/16 - 12
6000-16	1-5/16 - 12
6000-20	1-5/8 - 12
6000-24	1-7/8 - 12
6000-32	2-1/2 - 12

Hydraulic Adapters & Tube Fittings

* Available in 316
Stainless Steel



6400-L JIC STRAIGHT CONNECTOR LONG

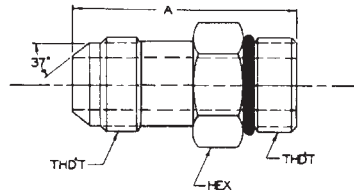

*

Part Number	Tube O.D.	JIC Male	ORB Male
6400-L-4-4	1/4	7/16 - 20	7/16 - 20
6400-L-5-5	5/16	1/2 - 20	1/2 - 20
6400-L-6-6	3/8	9/16 - 18	9/16 - 18
6400-L-8-8	1/2	3/4 - 16	3/4 - 16
6400-L-10-10	5/8	7/8 - 14	7/8 - 14
6400-L-12-12	3/4	1-1/16 - 12	1-1/16 - 12
6400-L-14-14	7/8	1-3/16 - 12	1-3/16 - 12
6400-L-16-16	1	1-5/16 - 12	1-5/16 - 12

6401 MALE ORB ADAPTER

*

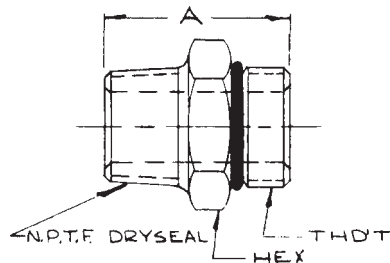

Part Number	Tube O.D.	ORB Male	NPTF Male	A	Hex
6401-4-2	1/4	7/16 - 20	1/8	15/16	9/16
6401-4-4	1/4	7/16 - 20	1/4	-	-
6401-5-2	5/16	1/2 - 20	1/8	15/16	5/8
6401-6-4	3/8	9/16 - 18	1/4	1-3/16	11/16
6401-6-6	3/8	9/16 - 18	3/8	-	-
6401-8-2	1/2	3/4 - 16	1/8	-	-
6401-8-4	1/2	3/4 - 16	1/4	-	-
6401-8-6	1/2	3/4 - 16	3/8	1-1/4	7/8
6401-8-8	1/2	3/4 - 16	1/2	-	-
6401-8-12	1/2	3/4 - 16	3/4	-	-
6401-8-16	1/2	3/4 - 16	1	-	-
6401-8-20	1/2	3/4 - 16	1-1/4	-	-
6401-8-24	1/2	3/4 - 16	1-1/2	-	-
6401-8-32	1/2	3/4 - 16	2	-	-
6401-10-8	5/8	7/8 - 14	1/2	1-9/16	1
6401-12-8	3/4	1-1/16 - 12	1/2	-	-
6401-12-12	3/4	1-1/16 - 12	3/4	1-47/64	1-1/4
6401-12-16	3/4	1-1/16 - 12	1	-	-
6401-16-16	1	1-5/16 - 12	1	1-29/64	1-1/2
6401-20-20	1-1/4	1-5/8 - 12	1-1/4	1-15/16	1-7/8
6401-24-24	1-1/2	1-7/8 - 12	1-1/2	1-63/64	2-1/8
6401-32-32	2	2-1/2 - 12	2	2	2-3/4

6402 ORB MALE X JIC FEMALE

*

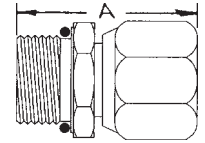

Part Number	Tube O.D.	ORB Male	JIC Female	A	Hex
6402-4-4	1/4	7/16 - 20	7/16-20	-	-
6402-6-6	3/8	9/16 - 18	9/16-18	-	-
6402-8-4	1/2	3/4 - 16	7/16-20	-	-
6402-8-5	1/2	3/4 - 16	1/2-20	-	-
6402-8-6	1/2	3/4 - 16	9/16-18	-	-
6402-8-8	1/2	3/4 - 16	3/4-16	-	-
6402-8-10	1/2	3/4 - 16	7/8-14	-	-
6402-8-12	1/2	3/4 - 16	1-1/16-12	-	-
6402-8-14	1/2	3/4 - 16	1-3/16-12	-	-
6402-8-16	1/2	3/4 - 16	1-5/16-12	-	-
6402-8-20	1/2	3/4 - 16	1-5/8-12	-	-
6402-10-10	5/8	7/8 - 14	7/8-14	-	-
6402-12-12	3/4	1-1/16 - 12	1-1/16-12	-	-
6402-16-16	1	1-5/16 - 12	1-5/16-12	-	-
6402-20-20	1-1/4	1-5/8 - 12	1-5/8-12	-	-

6404 FEMALE ORB ADAPTER

*

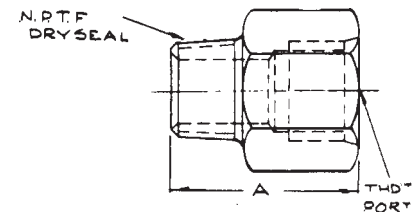

Part Number	Port Size	ORB Female	NPTF Male	A	Hex
6404-4-2	1/4	7/16 - 20	1/8	1-3/8	11/16
6404-4-4	1/4	7/16 - 20	1/4	-	-
6404-5-2	5/16	1/2 - 20	1/8	1-3/8	3/4
6404-6-4	3/8	9/16 - 18	1/4	1-35/64	7/8
6404-6-6	3/8	9/16 - 18	3/8	-	-
6404-6-8	3/8	9/16 - 18	1/2	-	-
6404-8-6	1/2	3/4 - 16	3/8	1-1/2	1
6404-8-8	1/2	3/4 - 16	1/2	-	-
6404-8-12	1/2	3/4 - 16	3/4	-	-
6404-10-6	5/8	7/8 - 14	3/8	-	-
6404-10-8	5/8	7/8 - 14	1/2	1-13/16	1-1/4
6404-12-8	3/4	1-1/16 - 12	1/2	-	-
6404-12-12	3/4	1-1/16 - 12	3/4	1-31/32	1-3/8
6404-14-12	7/8	1-3/16 - 12	3/4	2-1/32	1-1/2
6404-16-16	1	1-5/16 - 12	1	2-5/32	1-7/8
6404-20-20	1-1/4	1-5/8 - 12	1-1/4	2-1/4	2
6404-24-24	1-1/2	1-7/8 - 12	1-1/2	2-9/32	2-1/4
6404-32-32	2	2-1/2 - 12	2	2-5/16	2-7/8



* Available in 316
Stainless Steel

Hydraulic Adapters & Tube Fittings

6405 MALE ORB CONNECTOR

*

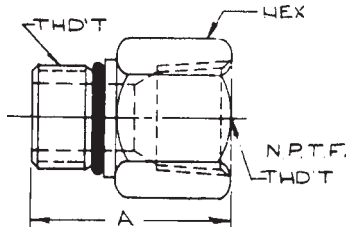

Part Number	Tube O.D.	ORB Male	NPTF Female	A	Hex
6405-4-2	1/4	7/16 - 20	1/8	31/32	9/16
6405-4-4	1/4	7/16 - 20	1/4	-	-
6405-5-2	5/16	1/2 - 20	1/8	1	5/8
6405-6-2	3/8	9/16 - 18	1/8	-	-
6405-6-4	3/8	9/16 - 18	1/4	1-9/32	3/4
6405-6-6	3/8	9/16 - 18	3/8	-	-
6405-6-8	3/8	9/16 - 18	1/2	-	-
6405-8-2	1/2	3/4 - 16	1/8	-	-
6405-8-4	1/2	3/4 - 16	1/4	-	-
6405-8-6	1/2	3/4 - 16	3/8	1-5/16	7/8
6405-8-8	1/2	3/4 - 16	1/2	-	-
6405-8-12	1/2	3/4 - 16	3/4	-	-
6405-8-16	1/2	3/4 - 16	1	-	-
6405-8-20	1/2	3/4 - 16	1-1/4	-	-
6405-8-24	1/2	3/4 - 16	1-1/2	-	-
6405-8-32	1/2	3/4 - 16	2	-	-
6405-10-4	5/8	7/8 - 14	1/4	-	-
6405-10-6	5/8	7/8 - 14	3/8	-	-
6405-10-8	5/8	7/8 - 14	1/2	1-35/64	1-1/8
6405-10-12	5/8	7/8 - 14	3/4	-	-
6405-12-6	3/4	1-1/16 - 12	3/8	-	-
6405-12-8	3/4	1-1/16 - 12	1/2	-	-
6405-12-12	3/4	1-1/16 - 12	3/4	1-55/64	1-3/8
6405-14-12	7/8	1-3/16 - 12	3/4	1-23/32	1-3/8
6405-16-8	1	1-5/16 - 12	1/2	-	-
6405-16-12	1	1-5/16 - 12	3/4	-	-
6405-16-16	1	1-5/16 - 12	1	1-29/32	1-5/8
6405-16-20	1	1-5/16 - 12	1-1/4	-	-
6405-20-16	1-1/4	1-5/8 - 12	1	-	-
6405-20-20	1-1/4	1-5/8 - 12	1-1/4	2-7/64	2
6405-20-24	1-1/4	1-5/8 - 12	1-1/2	-	-
6405-24-20	1-1/2	1-7/8 - 12	1-1/4	-	-
6405-24-24	1-1/2	1-7/8 - 12	1-1/2	2-7/64	2-3/8
6405-32-32	2	2-1/2 - 12	2	2-11/64	2-7/8

6407 ORB BULKHEAD

*

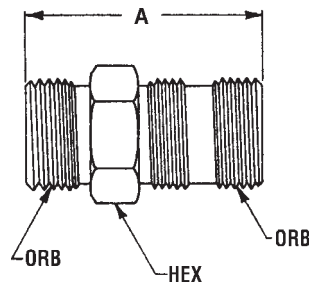

Part Number	Tube O.D.	ORB Male	ORB Male	A	Hex
6407-4-4	1/4	7/16 - 20	7/16 - 20	-	-
6407-6-6	3/8	9/16 - 18	9/16 - 18	-	-
6407-8-8	1/2	3/4 - 16	3/4 - 16	-	-
6407-10-10	5/8	7/8 - 14	7/8 - 14	-	-
6407-12-12	3/4	1-1/16 - 12	1-1/16 - 12	-	-
6407-16-16	1	1-5/16 - 12	1-5/16 - 12	-	-
6407-20-20	1-1/4	1-5/8 - 12	1-5/8 - 12	-	-
6407-24-24	1-1/2	1-7/8 - 12	1-7/8 - 12	-	-

6408 PLUG

*

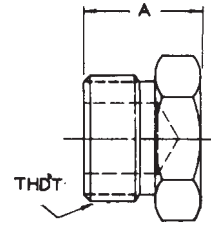

Part Number	Tube O.D.	ORB Male	A	Hex
6408-2	1/8	5/16-24	-	-
6408-3	3/16	3/8-24	-	-
6408-4	1/4	7/16-20	39/64	9/16
6408-5	5/16	1/2-20	39/64	5/8
6408-6	3/8	9/16-18	11/16	11/16
6408-8	1/2	3/4-16	3/4	7/8
6408-10	5/8	7/8-14	13/16	1
6408-12	3/4	1-1/16-12	1	1-1/4
6408-14	7/8	1-3/16-12	1	1-3/8
6408-16	1	1-5/16-12	1	1-1/2
6408-20	1-1/4	1-5/8-12	1	1-7/8
6408-24	1-1/2	1-7/8-12	1	2-1/8
6408-32	2	2-1/2-12	1	2-3/4

6409 ORB HOLLOW HEX PLUG

*

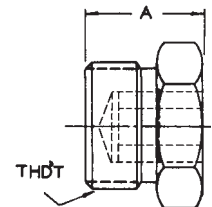

Part Number	Tube O.D.	ORB Male	A
6409-2	1/8	5/16 - 24	-
6409-3	3/16	3/8 - 24	-
6409-4	1/4	7/16 - 20	-
6409-5	5/16	1/2 - 20	-
6409-6	3/8	9/16 - 18	-
6409-8	1/2	3/4 - 16	-
6409-10	5/8	7/8 - 14	-
6409-12	3/4	1-1/16 - 12	-
6409-14	7/8	1-3/16 - 12	-
6409-16	1	1-5/16 - 12	-
6409-20	1-1/4	1-5/8 - 12	-
6409-24	1-1/2	1-7/8 - 12	-
6409-32	2	2-1/2 - 12	-

Hydraulic Adapters & Tube Fittings

* Available in 316 Stainless Steel



6410 ORB PORT BUSHING

*

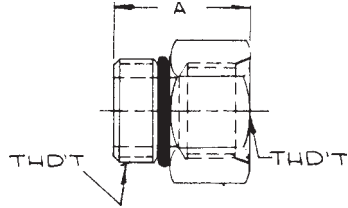

Part Number	Tube O.D.	ORB Male	ORB Female	A	Hex
6410-4-6	1/4	7/16 - 20	9/16 - 18	-	-
6410-6-2	3/8	9/16 - 18	3/8 - 24	-	-
6410-6-4	3/8	9/16 - 18	7/16 - 20	31/32	11/16
6410-6-8	3/8	9/16 - 18	3/4 - 16	-	-
6410-8-4	1/2	3/4 - 16	7/16 - 20	-	-
6410-8-5	1/2	3/4 - 16	1/2 - 20	-	-
6410-8-6	1/2	3/4 - 16	9/16 - 18	1-1/16	7/8
6410-8-10	1/2	3/4 - 16	7/8 - 14	-	-
6410-8-12	1/2	3/4 - 16	1-1/16 - 12	-	-
6410-8-14	1/2	3/4 - 16	1-3/16 - 12	-	-
6410-8-16	1/2	3/4 - 16	1-5/16 - 12	-	-
6410-8-20	1/2	3/4 - 16	1-5/8 - 12	-	-
6410-10-6	5/8	7/8 - 14	9/16 - 18	-	-
6410-10-8	5/8	7/8 - 14	3/4 - 16	1-1/4	1
6410-10-12	5/8	7/8 - 14	1-1/16 - 12	-	-
6410-12-4	3/4	1-1/16 - 12	7/16 - 20	-	-
6410-12-8	3/4	1-1/16 - 12	3/4 - 16	-	-
6410-12-10	3/4	1-1/16 - 12	7/8 - 14	1-7/16	1-1/4
6410-12-16	3/4	1-1/16 - 12	1-5/16 - 12	-	-
6410-14-12	7/8	1-3/16 - 12	1-1/16 - 12	1-19/32	1-3/8
6410-16-8	1	1-5/16 - 12	3/4 - 16	-	-
6410-16-10	1	1-5/16 - 12	7/8 - 14	-	-
6410-16-12	1	1-5/16 - 12	1-1/16 - 12	-	-
6410-16-14	1	1-5/16 - 12	1-3/16 - 12	1-19/32	1-1/2
6410-16-20	1	1-5/16 - 12	1-5/8 - 12	-	-
6410-20-12	1-1/4	1-5/8 - 12	1-1/16 - 12	-	-
6410-20-16	1-1/4	1-5/8 - 12	1-5/16 - 12	1	1-7/8
6410-20-24	1-1/4	1-5/8 - 12	1-7/8 - 12	-	-
6410-24-12	1-1/2	1-7/8 - 12	1-1/16 - 12	-	-
6410-24-16	1-1/2	1-7/8 - 12	1-5/16 - 12	-	-
6410-24-20	1-1/2	1-7/8 - 12	1-5/8 - 12	1-19/32	2-1/8
6410-32-24	2	2-1/2 - 12	1-7/8 - 12	1	2-3/4

6500 90° SWIVEL ELBOW

*

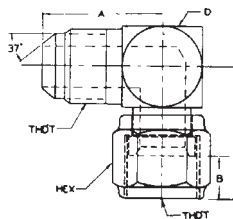

Part Number	Tube O.D.	JIC Male	JIC Female	A	B +015 -000	C	D Max	Hex
6500-4	1/4	7/16 - 20	7/16 - 20	55/64	.344	1	9/16	9/16
6500-4-6	1/4	7/16 - 20	9/16 - 18	-	-	-	-	-
6500-5	5/16	1/2 - 20	1/2 - 20	59/64	.375	1-1/16	5/8	5/8
6500-6	3/8	9/16 - 18	9/16 - 18	1-1/32	.375	1-1/4	13/16	11/16
6500-6-8	3/8	9/16 - 18	3/4 - 16	-	-	-	-	-
6500-8-6	1/2	3/4 - 16	9/16 - 18	-	-	-	-	-
6500-8	1/2	3/4 - 16	3/4 - 16	1-7/32	.422	1-3/8	7/8	7/8
6500-8-10	1/2	3/4 - 16	7/8 - 14	-	-	-	-	-
6500-10-8	5/8	7/8 - 14	3/4 - 16	-	-	-	-	-
6500-10	5/8	7/8 - 14	7/8 - 14	1-27/64	.500	1-5/8	1-1/8	1
6500-12	3/4	1-1/16 - 12	1-1/16 - 12	1-5/8	.562	1-3/4	1-3/8	1-1/4
6500-14	7/8	1-3/16 - 12	1-3/16 - 12	1-23/32	.578	1-25/32	1-1/2	1-3/8
6500-16	1	1-5/16 - 12	1-5/16 - 12	1-25/32	.594	2	1-5/8	1-1/2
6500-20	1-1/4	1-5/8 - 12	1-5/8 - 12	2-1/32	.625	2-5/16	2-1/8	2
6500-24	1-1/2	1-7/8 - 12	1-7/8 - 12	2-19/64	.734	2-19/32	2-1/4	2-1/4
6500-32	2	2-1/2 - 12	2-1/2 - 12	3-1/32	.938	3-3/8	3-1/4	2-7/8

6500-L 90° SWIVEL ELBOW LONG

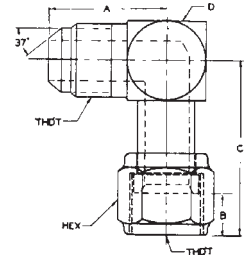

Part Number	Tube O.D.	JIC Male	JIC Female	A	B	C	D	Hex
6500-L-4	1/4	7/16 - 20	7/16 - 20	-	-	-	-	-
6500-L-6	3/8	9/16 - 18	9/16 - 18	-	-	-	-	-
6500-L-8	1/2	3/4 - 16	3/4 - 16	-	-	-	-	-
6500-L-10	5/8	7/8 - 14	7/8 - 14	-	-	-	-	-
6500-L-12	3/4	1-1/16 - 12	1-1/16 - 12	-	-	-	-	-

6501 90° SWIVEL ADAPTER

*

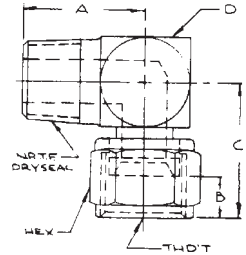

Part Number	Tube O.D.	NPTF Male	JIC Female	A	B +015 -000	C	D Min.	Hex
6501-2-4	1/4	1/8	7/16 - 20	25/32	.344	1	7/16	9/16
6501-2-5	5/16	1/8	1/2 - 20	25/32	.375	1-1/16	1/2	5/8
6501-4-4	1/4	1/4	7/16 - 20	-	-	-	-	-
6501-4-6	3/8	1/4	9/16 - 18	1-3/32	.375	1-1/4	9/16	11/16
6501-6	3/8	3/8	9/16 - 18	-	-	-	-	-
6501-6-8	1/2	3/8	3/4 - 16	1-7/32	.422	1-3/8	3/4	7/8
6501-8	1/2	1/2	3/4 - 16	-	-	-	-	-
6501-8-10	5/8	1/2	7/8 - 14	1-15/32	.500	1-5/8	7/8	1
6501-12-12	3/4	3/4	1-1/16 - 12	1-19/32	.562	1-3/4	1-1/16	1-1/4
6501-12-14	7/8	3/4	1-3/16 - 12	1-11/16	.578	1-25/32	1-3/16	1-3/8
6501-16-16	1	1	1-5/16 - 12	1-31/32	.594	2	1-5/16	1-1/2
6501-20-20	1-1/4	1-1/4	1-5/8 - 12	2-3/8	.625	2-5/16	1-5/8	2
6501-24-24	1-1/2	1-1/2	1-7/8 - 12	2-5/8	.734	2-19/32	1-7/8	2-1/4
6501-32-32	2	2	2-1/2 - 12	3	.938	3-3/8	2-1/2	2-7/8



* Available in 316
Stainless Steel

Hydraulic Adapters & Tube Fittings

6502 45° SWIVEL ELBOW

*

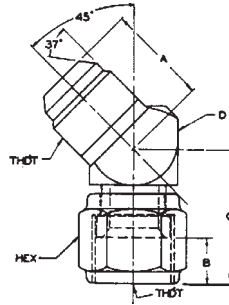

Part Number	Tube O.D.	JIC Male	JIC Female	A	B +015 -000	C	D	Hex
6502-4	1/4	7/16 - 20	7/16 - 20	45/64	.344	15/16	1/2	9/16
6502-5	5/16	1/2 - 20	1/2 - 20	3/4	.375	1	9/16	5/8
6502-6	3/8	9/16 - 18	9/16 - 18	13/16	.375	1-1/8	5/8	11/16
6502-8	1/2	3/4 - 16	3/4 - 16	31/32	.422	1-9/32	13/16	7/8
6502-10	5/8	7/8 - 14	7/8 - 14	1-3/32	.500	1-7/16	15/16	1
6502-12	3/4	1-1/16 - 12	1-1/16 - 12	1-17/64	.562	1-1/2	1-1/8	1-1/4
6502-14	7/8	1-3/16 - 12	1-3/16 - 12	1-3/8	.578	1-5/8	1-1/4	1-3/8
6502-16	1	1-5/16 - 12	1-5/16 - 12	1-29/64	.594	1-3/4	1-3/8	1-1/2
6502-20	1-1/4	1-5/8 - 12	1-5/8 - 12	1-37/64	.625	2-1/32	1-3/4	2
6502-24	1-1/2	1-7/8 - 12	1-7/8 - 12	1-49/64	.734	2-1/4	2	2-1/4
6502-32	2	2-1/2 - 12	2-1/2 - 12	2-13/64	.938	2-29/32	2-5/8	2-7/8

6503 90° NPTF FEMALE X JIC FEMALE

*

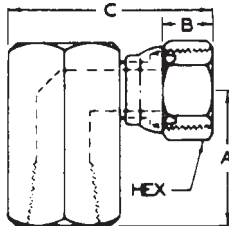

Part Number	Tube O.D.	NPTF Female	JIC Female	A	B	C	Hex
6503-4-4	1/4	1/4	7/16 - 20	-	-	-	-
6503-6-6	3/8	3/8	9/16 - 18	-	-	-	-
6503-8-8	1/2	1/2	3/4 - 16	-	-	-	-
6503-12-12	3/4	3/4	1-1/16 - 12	-	-	-	-
6503-16-16	1	1	1-5/16 - 12	-	-	-	-

6504 JIC MALE X JIC FEMALE

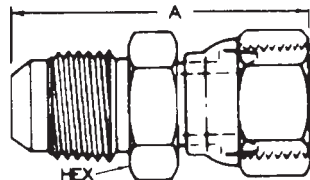

Part Number	Tube O.D.	JIC Male	JIC Female	A	Hex
6504-4-4	1/4	7/16 - 20	7/16 - 20	-	-
6504-6-6	3/8	9/16 - 18	9/16 - 18	-	-
6504-8-8	1/2	3/4 - 16	3/4 - 16	-	-
6504-10-10	5/8	7/8 - 14	7/8 - 14	-	-
6504-12-12	3/4	1-1/16 - 12	1-1/16 - 12	-	-
6504-16-16	1	1-5/16 - 12	1-5/16 - 12	-	-
6504-20-20	1-1/4	1-5/8 - 12	1-5/8 - 12	-	-

6505 NPTF MALE X JIC FEMALE

*

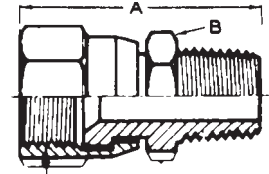

Part Number	Tube O.D.	NPTF Male	JIC Female	A	B
6505-2-4	1/4	1/8	7/16 - 20	-	-
6505-4-4	1/4	1/4	7/16 - 20	-	-
6505-4-5	5/16	1/4	1/2 - 20	-	-
6505-4-6	3/8	1/4	9/16 - 18	-	-
6505-6-6	3/8	3/8	9/16 - 18	-	-
6505-6-8	1/2	3/8	3/4 - 16	-	-
6505-8-8	1/2	1/2	3/4 - 16	-	-
6505-8-10	5/8	1/2	7/8 - 14	-	-
6505-12-12	3/4	3/4	1-1/16 - 12	-	-
6505-16-16	1	1	1-5/16 - 12	-	-
6505-20-20	1-1/4	1-1/4	1-5/8 - 12	-	-
6505-24-24	1-1/2	1-1/2	1-7/8 - 12	-	-
6505-32-32	2	2	2-1/2 - 12	-	-

6506 NPTF FEMALE X JIC FEMALE

*

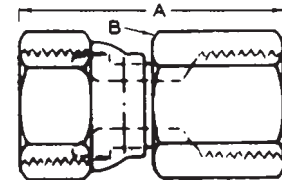

Part Number	Tube O.D.	NPTF Female	JIC Female	A	B
6506-2-4	1/4	1/8	7/16-20	-	-
6506-4-4	1/4	1/4	7/16-20	-	-
6506-4-6	3/8	1/4	9/16-18	-	-
6506-6-6	3/8	3/8	9/16-18	-	-
6506-6-8	1/2	3/8	3/4-16	-	-
6506-8-6	3/8	1/2	9/16-18	-	-
6506-8-8	1/2	1/2	3/4-16	-	-
6506-8-10	5/8	1/2	7/8-14	-	-
6506-12-10	5/8	3/4	7/8-14	-	-
6506-12-12	3/4	3/4	1-1/16-12	-	-
6506-12-14	7/8	3/4	1-3/16-12	-	-
6506-16-16	1	1	1-5/16-12	-	-
6506-20-20	1-1/4	1-1/4	1-5/8-12	-	-
6506-24-24	1-1/2	1-1/2	1-7/8-12	-	-
6506-32-32	2	2	2-1/2-12	-	-

Hydraulic Adapters & Tube Fittings

* Available in 316
Stainless Steel



6600 SWIVEL TEE-OUTLET

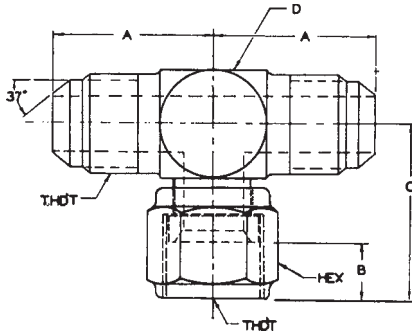

Part Number	Tube O.D.	JIC Male	JIC Male	JIC Female	A	B +015 -000	C	D Max	Hex
6600-4	1/4	7/16-20	7/16-20	7/16-20	55/64	.344	1	9/16	9/16
6600-5	5/16	1/2-20	1/2-20	1/2-20	59/64	.375	1-1/16	5/8	5/8
6600-6	3/8	9/16-18	9/16-18	9/16-18	1-1/32	.375	1-1/4	13/16	11/16
6600-8	1/2	3/4-16	3/4-16	3/4-16	1-7/32	.422	1-3/8	7/8	7/8
6600-10	5/8	7/8-14	7/8-14	7/8-14	1-27/64	.500	1-5/8	1-1/8	1
6600-12	3/4	1-1/16-12	1-1/16-12	1-1/16-12	1-5/8	.562	1-3/4	1-3/8	1-1/4
6600-14	7/8	1-3/16-12	1-3/16-12	1-3/16-12	1-23/32	.578	1-25/32	1-1/2	1-3/8
6600-16	1	1-5/16-12	1-5/16-12	1-5/16-12	1-25/32	.594	2	1-5/8	1-1/2
6600-20	1 1/4	1-5/8-12	1-5/8-12	1-5/8-12	2-1/32	.625	2-5/16	2-1/8	2
6600-24	1 1/2	1-7/8-12	1-7/8-12	1-7/8-12	2-19/64	.734	2-19/32	2-1/4	2-1/4
6600-32	2	2-1/2-12	2-1/2-12	2-1/2-12	3-1/32	.938	3-3/8	3-1/4	2-7/8

6602 SWIVEL TEE-RUN

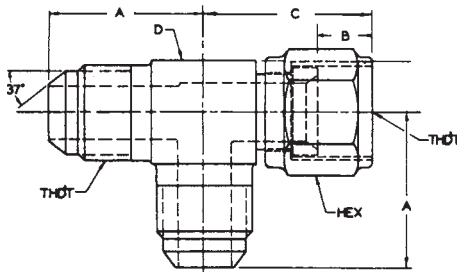

Part Number	Tube O.D.	JIC Male	JIC Female	JIC Male	A	B +015 -000	C	D Max	Hex
6602-4	1/4	7/16 - 20	7/16 - 20	7/16 - 20	55/64	.344	1	9/16	9/16
6602-5	5/16	1/2 - 20	1/2 - 20	1/2 - 20	59/64	.375	1-1/16	5/8	5/8
6602-6	3/8	9/16 - 18	9/16 - 18	9/16 - 18	1-1/32	.375	1-1/4	13/16	11/16
6602-8	1/2	3/4 - 16	3/4 - 16	3/4 - 16	1-7/32	.422	1-3/8	7/8	7/8
6602-8-8-12	1/2	3/4 - 16	3/4 - 16	1-1/16 - 12	-	-	-	-	-
6602-10	5/8	7/8 - 14	7/8 - 14	7/8 - 14	1-27/64	.500	1-5/8	1-1/8	1
6602-12	3/4	1-1/16 - 12	1-1/16 - 12	1-1/16 - 12	1-5/8	.52	1-3/4	1-3/8	1-1/4
6602-14	7/8	1-3/16 - 12	1-3/16 - 12	1-3/16 - 12	1-23/32	.578	1-25/32	1-1/2	1-3/8
6602-16	1	1-5/16 - 12	1-5/16 - 12	1-5/16 - 12	1-25/32	.594	2	1-5/8	1-1/2
6602-20	1-1/4	1-5/8 - 12	1-5/8 - 12	1-5/8 - 12	2-1/32	.625	2-5/16	2-1/8	2
6602-24	1-1/2	1-7/8 - 12	1-7/8 - 12	1-7/8 - 12	2-19/64	.734	2-19/32	2-1/4	2-1/4
6602-32	2	2-1/2 - 12	2-1/2 - 12	2-1/2 - 12	3-1/32	.938	3-3/8	3-1/4	2-7/8

6801 90° ADJUSTABLE ELBOW

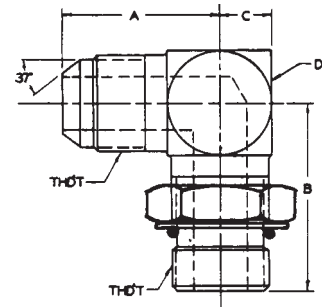

Part Number	Tube O.D.	JIC Male	ORB Male	A	B	C	D Max
6801-2	1/8	5/16 - 24	5/16 - 24	-	-	-	-
6801-3	3/16	3/8 - 24	3/8 - 24	-	-	-	-
6801-4	1/4	7/16 - 20	7/16 - 20	55/64	1-1/64	9/32	9/16
6801-4-5	1/4	7/16 - 20	1/2 - 20	-	-	-	-
6801-4-6	1/4	7/16 - 20	9/16 - 18	-	-	-	-
6801-4-8	1/4	7/16 - 20	3/4 - 16	-	-	-	-
6801-5-4	5/16	1/2 - 20	7/16 - 20	-	-	-	-
6801-5	5/16	1/2 - 20	1/2 - 20	59/64	1-5/64	5/16	5/8
6801-5-6	5/16	1/2 - 20	9/16 - 18	-	-	-	-
6801-6-4	3/8	9/16 - 18	7/16 - 20	-	-	-	-
6801-6-5	3/8	9/16 - 18	1/2 - 20	-	-	-	-
6801-6	3/8	9/16 - 18	9/16 - 18	1-1/32	1-15/64	13/32	13/16
6801-6-8	3/8	9/16 - 18	3/4 - 16	-	-	-	-
6801-6-10	3/8	9/16 - 18	7/8 - 14	-	-	-	-
6801-8-6	1/2	3/4 - 16	9/16 - 18	-	-	-	-
6801-8	1/2	3/4 - 16	3/4 - 16	1-7/32	1-7/16	7/16	7/8
6801-8-10	1/2	3/4 - 16	7/8 - 14	-	-	-	-
6801-8-12	1/2	3/4 - 16	1-1/16 - 12	-	-	-	-
6801-10-6	5/8	7/8 - 14	9/16 - 18	-	-	-	-
6801-10-8	5/8	7/8 - 14	3/4 - 16	-	-	-	-
6801-10	5/8	7/8 - 14	7/8 - 14	1-27/64	1-11/16	9/16	1-1/8
6801-10-12	5/8	7/8 - 14	1-1/16 - 12	-	-	-	-
6801-12-8	3/4	1-1/16 - 12	3/4 - 16	-	-	-	-
6801-12-10	3/4	1-1/16 - 12	7/8 - 14	-	-	-	-
6801-12	3/4	1-1/16 - 12	1-1/16 - 12	1-5/8	1-59/64	11/16	1-3/8
6801-12-14	3/4	1-1/16 - 12	1-3/16 - 12	-	-	-	-
6801-12-16	3/4	1-1/16 - 12	1-5/16 - 12	-	-	-	-
6801-12-20	3/4	1-1/16 - 12	1-5/8 - 12	-	-	-	-
6801-14-12	7/8	1-3/16 - 12	1-1/16 - 12	-	-	-	-
6801-14	7/8	1-3/16 - 12	1-3/16 - 12	1-23/32	1-63/64	3/4	1-1/2
6801-16-12	1	1-5/16 - 12	1-1/16 - 12	-	-	-	-
6801-16-14	1	1-5/16 - 12	1-3/16 - 12	-	-	-	-
6801-16	1	1-5/16 - 12	1-5/16 - 12	1-25/32	2-1/32	13/16	1-5/8
6801-16-20	1	1-5/16 - 12	1-5/8 - 12	-	-	-	-
6801-20-16	1-1/4	1-5/8 - 12	1-5/16 - 12	-	-	-	-
6801-20	1-1/4	1-5/8 - 12	1-5/8 - 12	2-1/32	2-15/64	1-1/16	2-1/8
6801-20-24	1-1/4	1-5/8 - 12	1-7/8 - 12	-	-	-	-
6801-24-20	1-1/2	1-7/8 - 12	1-5/8 - 12	-	-	-	-
6801-24	1-1/2	1-7/8 - 12	1-7/8 - 12	2-19/64	2-3/8	1-1/8	2-1/4
6801-32	2	2-1/2 - 12	2-1/2 - 12	3-1/32	2-7/8	1-5/8	3-1/4



* Available in 316
Stainless Steel

Hydraulic Adapters & Tube Fittings

6801-L ADJUSTABLE ELBOW LONG

*

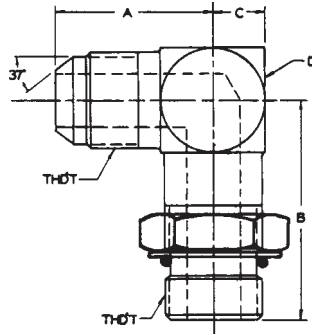

Part Number	Tube O.D.	JIC Male	ORB Male	A	B	C	D
6801-L-6	3/8	9/16 - 18	9/16 - 18	-	-	-	-
6801-L-8	1/2	3/4 - 16	3/4 - 16	-	-	-	-
6801-L-10	5/8	7/8 - 14	7/8 - 14	-	-	-	-
6801-L-12	3/4	1-1/16 - 12	1-1/16 - 12	-	-	-	-
6801-L-16	1	1-5/16 - 12	1-5/16 - 12	-	-	-	-

6802 45° ADJUSTABLE ELBOW

*

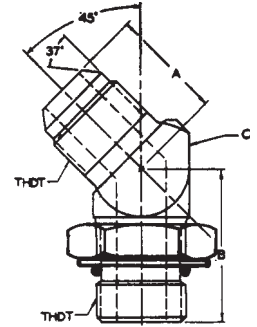

Part Number	Tube O.D.	JIC Male	ORB Male	A	B	C Max
6802-4	1/4	7/16 - 20	7/16 - 20	45/64	1-1/32	9/16
6802-5	5/16	1/2 - 20	1/2 - 20	3/4	1-1/32	5/8
6802-6-4	3/8	9/16 - 18	7/16 - 20	-	-	-
6802-6	3/8	9/16 - 18	9/16 - 18	13/16	1-1/8	13/16
6802-6-8	3/8	9/16 - 18	3/4 - 16	-	-	-
6802-8-6	1/2	3/4 - 16	9/16 - 18	-	-	-
6802-8	1/2	3/4 - 16	3/4 - 16	31/32	1-9/32	7/8
6802-8-10	1/2	3/4 - 16	7/8 - 14	-	-	-
6802-10-8	5/8	7/8 - 14	3/4 - 16	-	-	-
6802-10	5/8	7/8 - 14	7/8 - 14	1-3/32	1-1/2	1-1/8
6802-10-12	5/8	7/8 - 14	1-1/16 - 12	-	-	-
6802-12-10	3/4	1-1/16 - 12	7/8 - 14	-	-	-
6802-12	3/4	1-1/16 - 12	1-1/16 - 12	1-17/64	1-23/32	1-3/8
6802-12-16	3/4	1-1/16 - 12	1-5/16 - 12	-	-	-
6802-14	7/8	1-3/16 - 12	1-3/16 - 12	1-3/8	1-25/32	1-1/2
6802-16-12	1	1-5/16 - 12	1-1/16 - 12	-	-	-
6802-16	1	1-5/16 - 12	1-5/16 - 12	1-29/64	1-27/32	1-5/8
6802-20	1-1/4	1-5/8 - 12	1-5/8 - 12	1-37/64	1-57/64	2-1/8
6802-24	1-1/2	1-7/8 - 12	1-7/8 - 12	1-49/64	1-57/64	2-1/4
6802-32	2	2-1/2 - 12	2-1/2 - 12	2-13/64	1-27/32	3-1/4

6801-LL ADJUSTABLE ELBOW EXTRA LONG

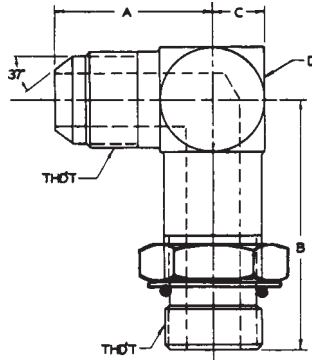

Part Number	Tube O.D.	JIC Male	ORB Male	A	B	C	D
6801-LL-6	3/8	9/16 - 18	9/16 - 18	-	-	-	-
6801-LL-8	1/2	3/4 - 16	3/4 - 16	-	-	-	-
6801-LL-10	5/8	7/8 - 14	7/8 - 14	-	-	-	-
6801-LL-12	3/4	1-1/16 - 12	1-1/16 - 12	-	-	-	-
6801-LL-16	1	1-5/16 - 12	1-5/16 - 12	-	-	-	-

6803 RUN TEE-ADJUSTABLE

*

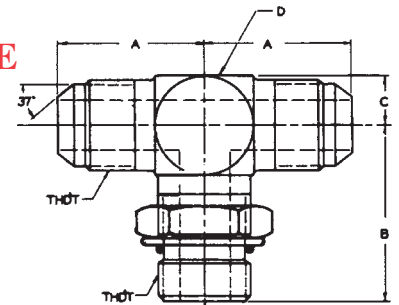

Part Number	Tube O.D.	JIC Male	JIC Male	ORB Male	A	B	C	D Max
6803-4	1/4	7/16 - 20	7/16 - 20	7/16 - 20	55/64	1-1/64	9/32	9/16
6803-5	5/16	1/2 - 20	1/2 - 20	1/2 - 20	59/64	1-5/64	5/16	5/8
6803-6	3/8	9/16 - 18	9/16 - 18	9/16 - 18	1-1/32	1-15/64	13/32	13/16
6803-8	1/2	3/4 - 16	3/4 - 16	3/4 - 16	1-7/32	1-7/16	7/16	7/8
6803-10	5/8	7/8 - 14	7/8 - 14	7/8 - 14	1-27/64	1-11/16	9/16	1-1/8
6803-12	3/4	1-1/16 - 12	1 1/16 - 12	1-1/16 - 12	1-5/8	1-59/64	11/16	1-3/8
6803-14	7/8	1-3/16 - 12	1 3/16 - 12	1-3/16 - 12	1-23/32	1-63/64	3/4	1-1/2
6803-16	1	1-5/16 - 12	1 5/16 - 12	1-5/16 - 12	1-25/32	2-1/32	13/16	1-5/8
6803-20	1-1/4	1-5/8 - 12	1 5/8 - 12	1-5/8 - 12	2-1/32	2-15/64	1-1/16	2-1/8
6803-24	1-1/2	1-7/8 - 12	1 7/8 - 12	1-7/8 - 12	2-19/64	2-3/8	1-1/8	2-1/4
6803-32	2	2-1/2 - 12	2 1/2 - 12	2- 1/2 - 12	3-1/32	2-7/8	1-5/8	3-1/4

Hydraulic Adapters & Tube Fittings

* Available in 316 Stainless Steel



6804 ADJUSTABLE TEE

*

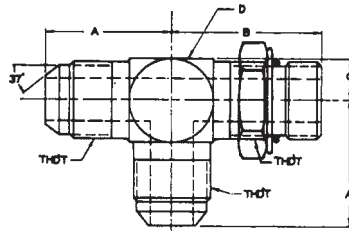

Part Number	Tube O.D.	JIC Male	ORB Male	JIC Male	A	B	C	D Max
6804-4	1/4	7/16 - 20	7/16 - 20	7/16 - 20	55/64	1-1/64	9/32	9/16
6804-5	5/16	1/2 - 20	1/2 - 20	1/2 - 20	59/64	1-5/64	5/16	5/8
6804-6	3/8	9/16 - 18	9/16 - 18	9/16 - 18	1-1/32	1-15/64	13/32	13/16
6804-8	1/2	3/4 - 16	3/4 - 16	3/4 - 16	1-7/32	1-7/16	7/16	7/8
6804-10	5/8	7/8 - 14	7/8 - 14	7/8 - 14	1-27/64	1-11/16	9/16	1-1/8
6804-12	3/4	1-1/16 - 12	1-1/16 - 12	1-1/16 - 12	1-5/8	1-59/64	11/16	1-3/8
6804-14	7/8	1-3/16 - 12	1-3/16 - 12	1-3/16 - 12	1-23/32	1-63/64	3/4	1-1/2
6804-16	1	1-5/16 - 12	1-5/16 - 12	1-5/16 - 12	1-25/32	2-1/32	13/16	1-5/8
6804-20	1-1/4	1-5/8 - 12	1-5/8 - 12	1-5/8 - 12	2-1/32	2-15/64	1-1/16	2-1/8
6804-24	1-1/2	1-7/8 - 12	1-7/8 - 12	1-7/8 - 12	2-19/64	2-3/8	1-1/8	2-1/4
6804-32	2	2-1/2 - 12	2-1/2 - 12	2-1/2 - 12	3-1/32	2-7/8	1-5/8	3-1/4

6806 90° ADJUSTABLE MALE ELBOW

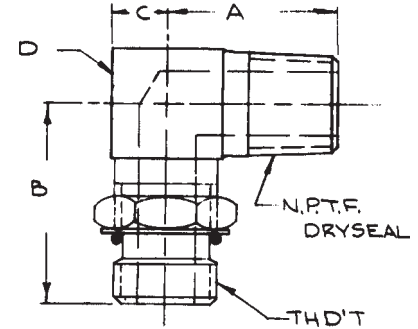

Part Number	Tube O.D.	ORB Male	NPTF Male	A	B	C	D
6806-4-2	1/4	7/16 - 20	1/8	25/32	1-1/64	1/4	1/2
6806-4-4	1/4	7/16 - 20	1/4	-	-	-	-
6806-5-2	5/16	1/2 - 20	1/8	25/32	1-5/64	9/32	9/16
6806-6-4	3/8	9/16 - 18	1/4	1-1/32	1-15/64	5/16	5/8
6806-6-6	3/8	9/16 - 18	3/8	-	-	-	-
6806-8-6	1/2	3/4 - 16	3/8	1-7/32	1-7/16	13/32	13/16
6806-8-8	1/2	3/4 - 16	1/2	-	-	-	-
6806-10-8	5/8	7/8 - 14	1/2	1-7/16	1-11/16	15/32	15/16
6806-12-12	3/4	1-1/16 - 12	3/4	1-19/32	1-59/64	9/16	1-1/8
6806-14-12	7/8	1-3/16 - 12	3/4	1-1/32	1-63/64	5/8	1-1/4
6806-16-16	1	1-5/16 - 12	1	1-31/32	2-1/32	11/16	1-3/8
6806-20-20	1-1/4	1-5/8 - 12	1-1/4	2-3/8	2-15/64	7/8	1-3/4
6806-24-24	1-1/2	1-7/8 - 12	1-1/2	2-5/8	2-3/8	1	2
6806-32-32	2	2-1/2 - 12	2	3-1/16	2	1-5/16	2-5/8

6805 90° ADJUSTABLE FEMALE ADAPTER

*

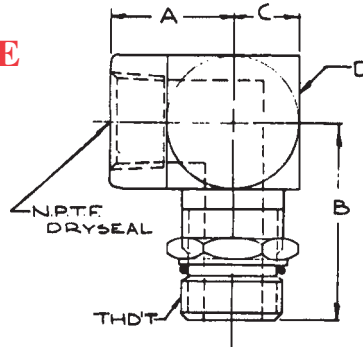

Part Number	Tube O.D.	ORB Male	NPTF Female	A	B	C	D
6805-4-2	1/4	7/16 - 20	1/8	41/64	1-5/64	5/16	5/8
6805-5-2	5/16	1/2 - 20	1/8	41/64	1-7/64	5/16	5/8
6805-6-4	3/8	9/16 - 18	1/4	13/16	1-15/64	3/8	3/4
6805-8-6	1/2	3/4 - 16	3/8	31/32	1-15/32	7/16	7/8
6805-10-6	5/8	7/8 - 14	3/8	-	-	-	-
6805-10-8	5/8	7/8 - 14	1/2	1-1/8	1-25/32	9/16	1-1/8
6805-12	3/4	1-1/16 - 12	3/4	-	-	-	-
6805-14-12	7/8	1-3/16 - 12	3/4	1-11/32	2-3/64	11/16	1-3/8
6805-16-12	1	1-5/16 - 12	3/4	-	-	-	-
6805-16	1	1-5/16 - 12	1	-	-	-	-
6805-20	1-1/4	1-5/8 - 12	1-1/4	-	-	-	-
6805-24	1-1/2	1-7/8 - 12	1-1/2	-	-	-	-
6805-32	2	2-1/2 - 12	2	-	-	-	-

6807 90° ORB MALE ADJUSTABLE

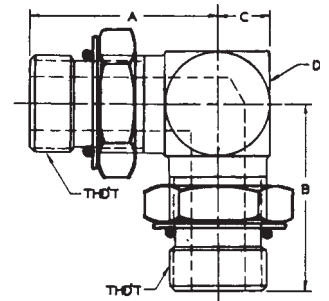

Part Number	Tube O.D.	ORB Male	ORB Male	A	B	C	D
6807-4-4	1/4	7/16 - 20	7/16 - 20	-	-	-	-
6807-6-6	3/8	9/16 - 18	9/16 - 18	-	-	-	-
6807-8-8	1/2	3/4 - 16	3/4 - 16	-	-	-	-
6807-10-10	5/8	7/8 - 14	7/8 - 14	-	-	-	-
6807-12-12	3/4	1-1/16 - 12	1-1/16 - 12	-	-	-	-
6807-16-16	1	1-5/16 - 12	1-5/16 - 12	-	-	-	-
6807-20-20	1-1/4	1-5/8 - 12	1-5/8 - 12	-	-	-	-
6807-24-24	1-1/2	1-7/8 - 12	1-7/8 - 12	-	-	-	-



* Available in 316
Stainless Steel

Hydraulic Adapters & Tube Fittings

6809 90° ORB MALE ADJUSTABLE X JIC FEMALE

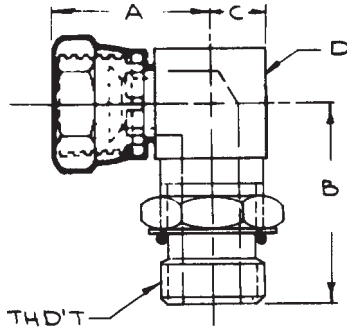

Part Number	Tube O.D.	ORB Male	JIC Female	A	B	C	D
6809-4-4	1/4	7/16 - 20	7/16 - 20	-	-	-	-
6809-6-6	3/8	9/16 - 18	9/16 - 18	-	-	-	-
6809-8-8	1/2	3/4 - 16	3/4 - 16	-	-	-	-
6809-10-10	5/8	7/8 - 14	7/8 - 14	-	-	-	-
6809-12-12	3/4	1-1/16 - 12	1-1/16 - 12	-	-	-	-
6809-16-16	1	1-5/16 - 12	1-5/16 - 12	-	-	-	-
6809-20-20	1-1/4	1-5/8 - 12	1-5/8 - 12	-	-	-	-

6901 90° BULKHEAD ADAPTER

*

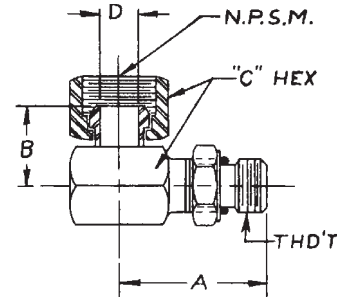

Part Number	Tube O.D.	ORB Male	NPSM Female	A	B	C	D
6901-4-4	1/4	7/16 - 20	1/4	1-7/64	3/4	11/16	15/64
6901-4-6	1/4	7/16 - 20	3/8	-	-	-	-
6901-6-4	3/8	9/16 - 18	1/4	-	-	-	-
6901-6-6	3/8	9/16 - 18	3/8	1-19/64	7/8	7/8	11/32
6901-6-8	3/8	9/16 - 18	1/2	-	-	-	-
6901-8-4	1/2	3/4 - 16	1/4	-	-	-	-
6901-8-6	1/2	3/4 - 16	3/8	-	-	-	-
6901-8-8	1/2	3/4 - 16	1/2	1-33/64	15/16	1	31/64
6901-8-12	1/2	3/4 - 16	3/4	-	-	-	-
6901-10-6	5/8	7/8 - 14	3/8	-	-	-	-
6901-10-8	5/8	7/8 - 14	1/2	-	-	-	-
6901-10-12	5/8	7/8 - 14	3/4	-	-	-	-
6901-12-8	3/4	1-1/16 - 12	1/2	-	-	-	-
6901-12-12	3/4	1-1/16 - 12	3/4	1-59/64	1-3/16	1-1/4	21/32
6901-12-16	3/4	1-1/16 - 12	1	-	-	-	-
6901-14-12	7/8	1-3/16 - 12	3/4	-	-	-	-
6901-16-12	1	1-5/16 - 12	3/4	-	-	-	-
6901-16-16	1	1-5/16 - 12	1	2-3/32	1-5/16	1-1/2	27/32
6901-20-12	1-1/4	1-5/8 - 12	3/4	-	-	-	-
6901-20-20	1-1/4	1-5/8 - 12	1-1/4	-	-	-	-
6901-24-24	1-1/2	1-7/8 - 12	1-1/2	-	-	-	-
6901-32-32	2	2-1/2 - 12	2	-	-	-	-

6900 BOSS TYPE UNION ADAPTER

*

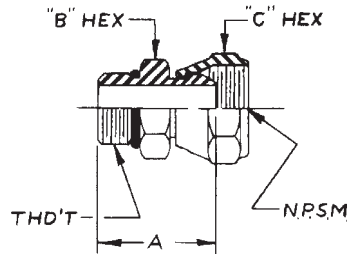

Part Number	Tube O.D.	ORB Male	NPSM Female	A	B Hex	C Hex
6900-4-4	1/4	7/16 - 20	1/4	1.050	9/16	11/16
6900-5-4	5/16	1/2 - 20	1/4	-	-	-
6900-6-4	3/8	9/16 - 18	1/4	-	-	-
6900-6-6	3/8	9/16 - 18	3/8	1.140	11/16	7/8
6900-6-8	3/8	9/16 - 18	1/2	-	-	-
6900-8-4	1/2	3/4 - 16	1/4	-	-	-
6900-8-6	1/2	3/4 - 16	3/8	-	-	-
6900-8-8	1/2	3/4 - 16	1/2	1.234	7/9	1
6900-8-12	1/2	3/4 - 16	3/4	-	-	-
6900-10-6	5/8	7/8 - 14	3/8	-	-	-
6900-10-8	5/8	7/8 - 14	1/2	-	-	-
6900-10-12	5/8	7/8 - 14	3/4	-	-	-
6900-12-8	3/4	1-1/16 - 12	1/2	-	-	-
6900-12-12	3/4	1-1/16 - 12	3/4	1.580	1-1/4	1-1/4
6900-12-16	3/4	1-1/16 - 12	1	-	-	-
6900-14-12	7/8	1-3/16 - 12	3/4	-	-	-
6900-16-12	1	1-5/16 - 12	3/4	-	-	-
6900-16-16	1	1-5/16 - 12	1	1.657	1-1/2	1-1/2
6900-20-12	1-1/4	1-5/8 - 12	3/4	-	-	-
6900-20-16	1-1/4	1-5/8 - 12	1	-	-	-
6900-20-20	1-1/4	1-5/8 - 12	1-1/4	1.688	1-7/8	1-7/8
6900-24-20	1-1/2	1-7/8 - 12	1-1/4	-	-	-
6900-24-24	1-1/2	1-7/8 - 12	1-1/2	1.781	2-1/8	2-1/8
6900-32-32	2	2-1/2 - 12	2	1.938	2-3/4	2-5/8

6902 45° BULKHEAD ADAPTER

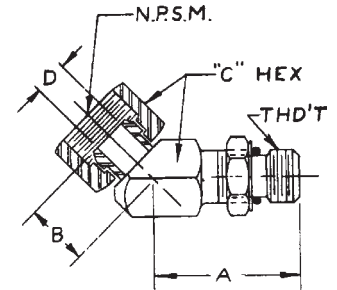

Part Number	Tube O.D.	ORB Male	NPSM Female	A	B	C	D
6902-4-4	1/4	7/16 - 20	1/4	-	-	-	-
6902-6-4	3/8	9/16 - 18	1/4	-	-	-	-
6902-6-6	3/8	9/16 - 18	3/8	1-1/16	45/64	7/8	11/32
6902-6-8	3/8	9/16 - 18	1/2	-	-	-	-
6902-8-6	1/2	3/4 - 16	3/8	-	-	-	-
6902-8-8	1/2	3/4 - 16	1/2	1-1/8	13/16	1	31/64
6902-8-12	1/2	3/4 - 16	3/4	-	-	-	-
6902-10-6	5/8	7/8 - 14	3/8	-	-	-	-
6902-10-8	5/8	7/8 - 14	3/4	-	-	-	-
6902-10-12	5/8	7/8 - 14	1/2	-	-	-	-
6902-12-8	3/4	1-1/16 - 12	3/4	1-1/2	31/32	1-1/4	21/32
6902-12-12	3/4	1-1/16 - 12	1	-	-	-	-
6902-16-16	1	1-5/16 - 12	1	-	-	-	-
6902-20-20	1-1/4	1-5/8 - 12	1-1/4	-	-	-	-
6902-24-24	1-1/2	1-7/8 - 12	1-1/2	-	-	-	-

O-Ring Face Seal Adapters



FF304-C CAP NUT

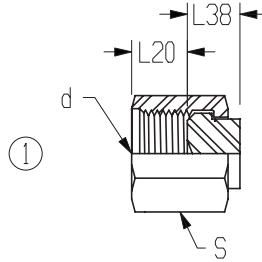

Part Number	Tube OD	d UN/UNF-2B	L20	L38	S
FF304-C-4	1/4	9/16 - 18	.31	.34	.69
FF304-C-6	3/8	11/16 - 16	.33	.37	.81
FF304-C-8	1/2	13/16 - 16	.39	.47	.94
FF304-C-10	5/8	1 - 14	.49	.47	1.13
FF304-C-12	3/4	1-3/16 - 12	.54	.53	1.38
FF304-C-16	1	1-7/16 - 12	.53	.59	1.63
FF304-C-20	1-1/4	1-11/16 - 12	.53	.59	1.88
FF304-C-24	1-1/2	2 - 12	.53	.59	2.25

FF318 TUBE NUT

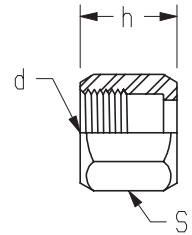

Part Number	Tube OD	d UN/UNF-2B	h2	S4
FF318-4	1/4	9/16 - 18	.58	.69
FF318-6	3/8	11/16 - 16	.67	.81
FF318-8	1/2	13/16 - 16	.83	.94
FF318-10	5/8	1 - 14	.93	1.13
FF318-12	3/4	1-3/16 - 12	1.02	1.38
FF318-16	1	1-7/16 - 12	1.10	1.63
FF318-20	1-1/4	1-11/16 - 12	1.10	1.88
FF318-24	1-1/2	2 - 12	1.10	2.25

FF306 BULKHEAD LOCK NUT

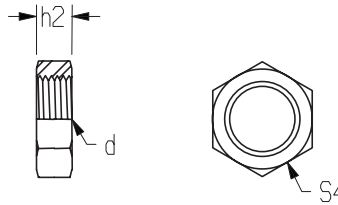

Part Number	Tube OD	d UN/UNF-2B	h2	S4
FF306-4 LN	1/4	9/16 - 18	.27	.81
FF306-6 LN	3/8	11/16 - 16	.31	1.00
FF306-8 LN	1/2	13/16 - 16	.35	1.13
FF306-10 LN	5/8	1 - 14	.41	1.31
FF306-12 LN	3/4	1-3/16 - 12	.41	1.50
FF306-16 LN	1	1-7/16 - 12	.41	1.75
FF306-20 LN	1-1/4	1-11/16 - 12	.41	2.00
FF306-24 LN	1-1/2	2 - 12	.41	2.38

FF319 TUBE SLEEVE

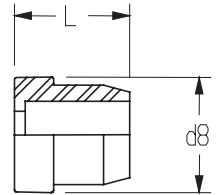

Part Number	Tube OD	L	d8
FF319-4 UNPL	1/4	.37	.50
FF319-6-4 UNPL	3/8-1/4	.41	.62
FF319-6 UNPL	3/8	.37	.62
FF319-8 UNPL	1/2	.37	.75
FF319-10 UNPL	5/8	.41	.92
FF319-12 UNPL	3/4	.55	1.10
FF319-16 UNPL	1	.61	1.35
FF319-20 UNPL	1-1/4	.61	1.60
FF319-24 UNPL	1-1/2	.61	1.71

FF306-N ADJUSTABLE LOCK NUT

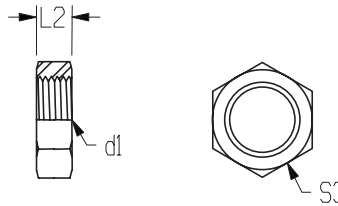

Part Number	Tube OD	d1 UN/UNF-2B	L2	S3
FF306-N-4	1/4	7/16 - 20	.31	.63
FF306-N-6	3/8	9/16 - 18	.33	.75
FF306-N-8	1/2	3/4 - 16	.41	.94
FF306-N-10	5/8	7/8 - 14	.45	1.06
FF306-N-12	3/4	1-1/16 - 12	.50	1.38
FF306-N-14	7/8	1-3/16 - 12	.50	1.50
FF306-N-16	1	1-5/16 - 12	.54	1.63
FF306-N-20	1-1/4	1-5/8 - 12	.54	1.88
FF306-N-24	1-1/2	1-7/8 - 12	.54	2.13

FF320 TUBE SLEEVE

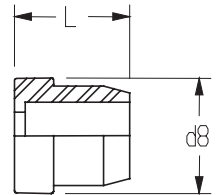

Part Number	Tube OD	L	d8
FF320-6	3/8	.34	.62
FF320-10	5/8	.42	.92
FF320-12	3/4	.48	1.09
FF320-16	1	.53	1.34
FF320-24	1-1/2	.49	1.91



O-Ring Face Seal Adapters

FF403 BRAZE TUBE UNION

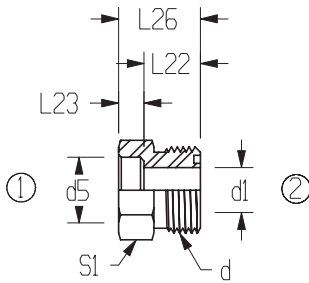

Part Number	Tube OD	d UN/UNF-2A	L26	L22	L23	S1	d1	d5
FF403-4-4	1/4-1/4	9/16 - 18	.86	.53	.33	.63	.17	.26
FF403-6-6	3/8-3/8	11/16 - 16	.90	.57	.33	.75	.26	.38
FF403-6-8	3/8-1/2	13/16 - 16	.97	.64	.33	.88	.26	.38
FF403-10-10	5/8-5/8	1 - 14	1.07	.74	.33	1.06	.48	.63
FF403-12-12	3/4-3/4	1-3/16 - 12	1.32	.83	.49	1.25	.61	.76
FF403-16-12	1-3/4	1-3/16 - 12	1.52	.97	.55	1.50	.61	1.01
FF403-16-16	1-1	1-7/16 - 12	1.52	.97	.55	1.50	.81	1.01
FF403-20-20	1-1/4 - 1-1/4	1-11/16 - 12	1.52	.97	.55	1.75	1.02	1.26
FF403-24-20	1-1/2 - 1-1/4	1-11/16 - 12	1.52	.97	.55	2.13	1.02	1.51

FF2403 MALE TUBE UNION

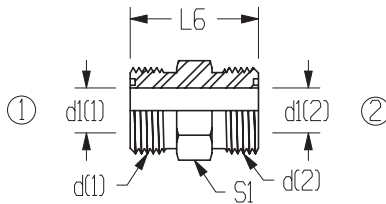

Part Number	Tube OD	d UN/UNF-2A	UN/UNF-2A	L22	L23	S1	d1
FF2403-4-4-O	1/4 - 1/4	9/16 - 18	9/16 - 18	1.08	.63	.17	.17
FF2403-6-4-O	3/8 - 1/4	11/16 - 16	9/16 - 18	1.17	.75	.26	.17
FF2403-6-6-O	3/8 - 3/8	11/16 - 16	11/16 - 16	1.22	.75	.26	.26
FF2403-8-6-O	1/2 - 3/8	13/16 - 16	11/16 - 16	1.33	.88	.38	.26
FF2403-8-8-O	1/2 - 1/2	13/16 - 16	13/16 - 16	1.39	.88	.38	.38
FF2403-10-8-O	5/8 - 1/2	1 - 14	13/16 - 16	1.57	1.06	.48	.38
FF2403-10-10-O	5/8 - 5/8	1 - 14	1 - 14	1.68	1.06	.48	.48
FF2403-12-8-O	3/4 - 1/2	1-3/16 - 12	13/16 - 16	1.69	1.25	.61	.38
FF2403-12-10-O	3/4 - 5/8	1-3/16 - 12	1 - 14	1.80	1.25	.61	.48
FF2403-12-12-O	3/4 - 3/4	1-3/16 - 12	1-3/16 - 12	1.86	1.25	.61	.61
FF2403-16-12-O	1 - 3/4	1-7/16 - 12	1-3/16 - 12	1.92	1.50	.81	.61
FF2403-16-16-O	1 - 1	1-7/16 - 12	1-7/16 - 12	1.94	1.50	.81	.81
FF2403-20-16-O	1-1/4 - 1	1-11/16 - 12	1-7/16 - 12	2.02	1.75	1.02	.81
FF2403-20-20-O	1-1/4 - 1-1/4	1-11/16 - 12	1-11/16 - 12	2.02	1.75	1.02	1.02
FF2403-24-24-O	1-1/2 - 1-1/2	2 - 12	2 - 12	2.09	2.13	1.26	1.26

FF2404 MALE CONNECTOR

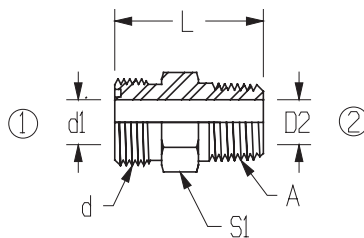

Part Number	Tube OD	d UN/UNF-2A	A NPTF	L	S1	d1	D2
FF2404-4-2-O	1/4	9/16 - 18	1/8 - 27	1.08	.63	.17	.17
FF2404-4-4-O	1/4	9/16 - 18	1/4 - 18	1.28	.63	.17	.17
FF2404-4-6-O	1/4	9/16 - 18	3/8 - 18	1.35	.75	.17	.17
FF2404-6-2-O	3/8	11/16 - 16	1/8 - 27	1.13	.75	.26	.19
FF2404-6-4-O	3/8	11/16 - 16	1/4 - 18	1.36	.75	.26	.26
FF2404-6-6-O	3/8	11/16 - 16	3/8 - 18	1.36	.75	.26	.26
FF2404-6-8-O	3/8	11/16 - 16	1/2 - 14	1.57	.88	.26	.26
FF2404-8-6-O	1/2	13/16 - 12	3/8 - 18	1.47	.88	.38	.38
FF2404-8-8-O	1/2	13/16 - 16	1/2 - 14	1.66	.88	.38	.38
FF2404-8-12-O	1/2	13/16 - 16	3/4 - 14	1.79	1.13	.38	.38
FF2404-10-8-O	5/8	1 - 14	1/2 - 14	1.84	1.06	.48	.48
FF2404-10-12-O	5/8	1 - 14	3/4 - 14	1.84	1.13	.48	.48
FF2404-12-8-O	3/4	1-3/16 - 12	1/2 - 14	1.96	1.25	.61	.53
FF2404-12-12-O	3/4	1-3/16 - 12	3/4 - 14	1.96	1.25	.61	.61
FF2404-12-16-O	3/4	1-3/16 - 12	1 - 11-1/2	2.19	1.38	.61	.61
FF2404-16-12-O	1	1-7/16 - 12	3/4 - 14	2.02	1.50	.81	.72
FF2404-16-16-O	1	1-7/16 - 12	1 - 11-1/2	2.21	1.50	.81	.81
FF2404-20-16-O	1-1/4	1-11/16 - 12	1 - 11-1/2	2.29	1.75	1.02	.94
FF2404-20-20-O	1-1/4	1-11/16 - 12	1-1/4 - 11-1/2	2.32	1.88	1.02	1.02
FF2404-24-24-O	1-1/2	2 - 12	1-1/2 - 11-1/2	2.42	2.13	1.26	1.26

O-Ring Face Seal Adapters



FF2407 REDUCING ADAPTER

Available with or without nut. Call customer service for availability.

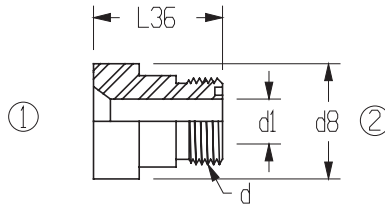

Part Number	Tube OD	D UN/UNF-2A	L36	d8	d1
FF2407-6-4-O	3/8 - 1/4	9/16 - 18	.77	.62	.17
FF2407-8-4-O	1/2 - 1/4	9/16 - 18	.86	.75	.17
FF2407-8-6-O	1/2 - 3/8	11/16 - 16	.88	.75	.26
FF2407-10-4-O	5/8 - 1/4	9/16 - 18	.90	.92	.17
FF2407-10-6-O	5/8 - 3/8	11/16 - 16	.95	.92	.26
FF2407-10-8-O	5/8 - 1/2	13/16 - 16	1.01	.92	.38
FF2407-12-4-O	3/4 - 1/4	9/16 - 18	.98	1.10	.17
FF2407-12-6-O	3/4 - 3/8	11/16 - 16	1.03	1.10	.26
FF2407-12-8-O	3/4 - 1/2	13/16 - 16	1.09	1.10	.38
FF2407-16-8-O	1 - 1/2	13/16 - 16	1.15	1.35	.38
FF2407-12-10-O	3/4 - 5/8	1 - 14	1.16	1.09	.48
FF2407-16-12-O	1 - 3/4	1-3/16 - 12	1.30	1.35	.61
FF2407-20-12-O	1-1/4 - 3/4	1-3/16 - 12	1.32	1.60	.61
FF2407-20-16-O	1-1/4 - 1	1-7/16 - 12	1.34	1.57	.81
FF2407-24-16-O	1-1/2 - 1	1-7/16 - 12	1.34	1.91	.81

FF2408 MALE TUBE PLUG

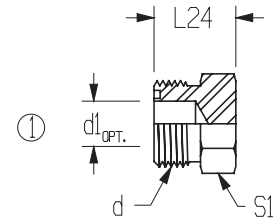

Part Number	Tube OD	d UN/UNF-2A	L24	S1	d1 (OPT)
FF2408-4-O	1/4	9/16 - 18	.66	.63	.17
FF2408-6-O	3/8	11/16 - 16	.75	.75	.26
FF2408-8-O	1/2	13/16 - 16	.85	.88	.38
FF2408-10-O	5/8	1 - 14	1.02	1.06	.48
FF2408-12-O	3/4	1-3/16 - 12	1.08	1.25	.61
FF2408-16-O	1	1-7/16 - 12	1.10	1.50	.81
FF2408-20-O	1-1/4	1-11/16 - 12	1.10	1.75	1.02
FF2408-24-O	1-1/2	2 - 12	1.10	2.13	1.26

FF2500 90° UNION ELBOW

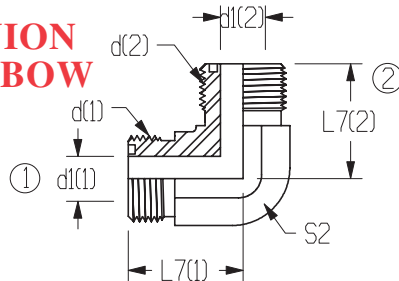

Part Number	Tube OD	d (1) UN/UNF-2A	d (2) UN/UNF-2A	L7 (1)	L7 (2)	S2	d1 (1)	d1 (2)
FF2500-4-4-O	1/4 - 1/4	9/16 - 18	9/16 - 18	.85	.85	.56	.17	.17
FF2500-6-6-O	3/8 - 3/8	11/16 - 16	11/16 - 16	.98	.98	.75	.26	.26
FF2500-8-8-O	1/2 - 1/2	13/16 - 16	13/16 - 16	1.10	1.10	.75	.38	.38
FF2500-10-10-O	5/8 - 5/8	1 - 14	1 - 14	1.31	1.31	1.06	.48	.48
FF2500-12-12-O	3/4 - 3/4	1-3/16 - 12	1-3/16 - 12	1.47	1.47	1.19	.61	.61
FF2500-16-16-O	1 - 1	1-7/16 - 12	1-7/16 - 12	1.64	1.64	1.44	.81	.81
FF2500-20-20-O	1-1/4 - 1-1/4	1-11/16 - 12	1-11/16 - 12	1.76	1.76	1.63	1.02	1.02
FF2500-24-24-O	1-1/2 - 1-1/2	2 - 12	2 - 12	1.92	1.92	1.88	1.26	1.26

FF2501 90° MALE ELBOW

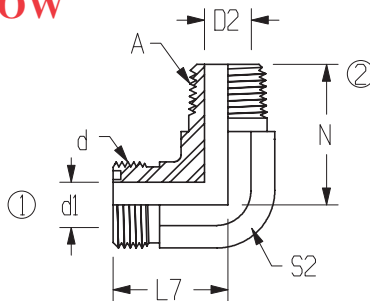

Part Number	Tube OD	d UN/UNF-2A	A NPTF	L7	N	S2	d1	D2
FF2501-4-2-O	1/4	9/16-18	1/8-27	.85	.80	.55	.17	.19
FF2501-4-4-O	1/4	9/16-18	1/4-18	.85	1.12	.56	.17	.28
FF2501-4-6-O	1/4	9/16-18	3/8-18	.85	1.22	.75	.17	.41
FF2501-6-4-O	3/8	11/16-16	1/4-18	.98	1.09	.75	.26	.28
FF2501-6-6-O	3/8	11/16-16	3/8-18	1.04	1.22	.75	.26	.41
FF2501-6-8-O	3/8	11/16-16	1/2-14	1.15	1.47	.88	.26	.53
FF2501-8-6-O	1/2	13/16-16	3/8-18	1.10	1.22	.75	.38	.41
FF2501-8-8-O	1/2	13/16-16	1/2-14	1.10	1.47	.94	.38	.53
FF2501-10-8-O	5/8	1-14	1/2-14	1.31	1.47	.94	.48	.53
FF2501-10-12-O	5/8	1-14	3/4-14	1.59	1.41	1.06	.48	.72
FF2501-12-8-O	3/4	1 3/16-12	1/2-14	1.59	1.47	1.19	.61	.53
FF2501-12-12-O	3/4	13/16-12	3/4-14	1.47	1.59	1.18	.61	.72
FF2501-12-16-O	3/4	1 3/16-12	1-11 1/2	1.62	2.01	1.44	.61	.94
FF2501-16-12-O	1	1 7/16-12	3/4-14	1.64	1.78	1.44	.81	.72
FF2501-16-16-O	1	1 7/16-12	1-11 1/2	1.64	2.01	1.44	.81	.94
FF2501-16-20-O	1	1 7/16-12	1 1/4-11 1/2	1.76	2.38	1.63	.81	1.25
FF2501-20-16-O	1 1/4	1 11/16-12	1-11 1/2	1.76	2.01	1.63	1.02	.94
FF2501-20-20-O	1 1/4	1 11/16-12	1 1/4-11 1/2	1.76	2.38	1.63	1.02	1.25
FF2501-20-24-O	1 1/4	1 11/16-12	1 1/2-11 1/2	1.92	2.43	1.88	1.02	1.50
FF2501-24-20-O	1 1/2	2-12	1 1/4-11 1/2	1.92	2.40	1.88	1.26	1.25
FF2501-24-24-O	1 1/2	2-12	1 1/2-11 1/2	1.92	2.43	1.88	1.26	1.50



O-Ring Face Seal Adapters

FF2502 90° FEMALE ELBOW

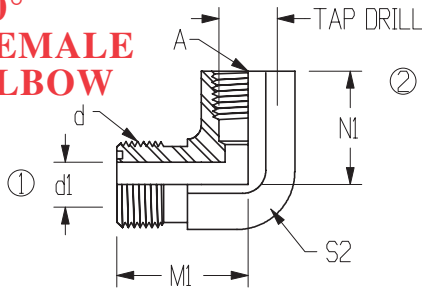

Part Number	Tube OD	d UN/UNF-2A	A NPTF	M1	N1	S2	d1	Tap Drill
FF2502-12-12-O	3/4	1-3/16 - 12	3/4 - 14	1.64	1.36	1.44	.61	.91
FF2502-16-16-O	1	1-7/16 - 12	1 - 11-1/2	1.76	1.62	1.63	.81	1.14
FF2502-20-20-O	1-1/4	1-11/16 - 12	1-1/4 - 11-1/2	1.92	1.70	1.88	1.02	1.48

FF2503 45° MALE ELBOW

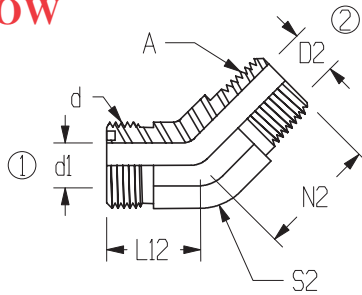

Part Number	Tube OD	D UN/UNF-2A	A NPTF	L12	N2	S2	d1	D2
FF2503-4-2-O	1/4	9/16 - 18	1/8 - 27	.63	.64	.55	.17	.19
FF2503-4-4-O	1/4	9/16 - 18	1/4 - 18	.68	.86	.55	.17	.28
FF2503-4-6-O	1/4	9/16 - 18	3/8 - 18	.68	.95	.75	.17	.41
FF2503-6-4-O	3/8	11/16 - 16	1/4 - 18	.74	.86	.75	.26	.28
FF2503-6-6-O	3/8	11/16 - 16	3/8 - 18	.74	.95	.75	.26	.41
FF2503-6-8-O	3/8	11/16 - 16	1/2 - 14	.74	1.17	.87	.26	.53
FF2503-8-6-O	1/2	13/16 - 16	3/8 - 18	.80	.95	.75	.38	.41
FF2503-8-8-O	1/2	13/16 - 16	1/2 - 14	.80	1.17	.75	.38	.53
FF2503-10-8-O	5/8	1 - 14	1/2 - 14	.92	1.17	1.06	.48	.53
FF2503-12-12-O	3/4	1-3/16 - 12	3/4 - 14	1.02	1.30	1.18	.61	.72
FF2503-12-16-O	3/4	1-3/16 - 12	1 - 11-1/2	1.02	1.48	1.42	.61	.94
FF2503-16-12-O	1	1-7/16 - 12	3/4 - 14	1.18	1.30	1.42	.81	.72
FF2503-16-16-O	1	1-7/16 - 12	1 - 11-1/2	1.18	1.48	1.42	.81	.94
FF2503-16-20-O	1	1-7/16 - 12	1-1/4 - 11-1/2	1.18	1.66	1.61	.81	1.25
FF2503-20-16-O	1-1/4	1-11/16 - 12	1 - 11-1/2	1.28	1.63	1.61	1.02	.94
FF2503-20-20-O	1-1/4	1-11/16 - 12	1-1/4 - 11-1/2	1.28	1.67	1.61	1.02	1.25

FF2603 UNION TEE

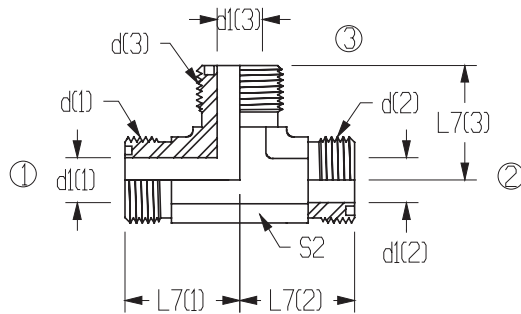

Part Number	Tube OD	d (1) UN/UNF-2A	d (2) UN/UNF-2A	d (3) UN/UNF-2A	L7 (1)	L7 (2)	L7 (3)	S2	d1 (1)	d1 (2)	d1 (3)
FF2603-4-4-4-O	1/4 - 1/4 - 1/4	9/16 - 18	9/16 - 18	9/16 - 18	.85	.85	.85	.56	.17	.17	.17
FF2603-6-6-6-O	3/8 - 3/8 - 3/8	11/16 - 16	11/16 - 16	11/16 - 16	.98	.98	.98	.75	.26	.26	.26
FF2603-8-8-6-O	1/2 - 1/2 - 3/8	13/16 - 16	13/16 - 16	11/16 - 16	1.10	1.10	1.04	.75	.38	.38	.26
FF2603-8-8-8-O	1/2 - 1/2 - 1/2	13/16 - 16	13/16 - 16	13/16 - 16	1.10	1.10	1.10	.75	.38	.38	.38
FF2603-8-8-10-O	1/2 - 1/2 - 5/8	13/16 - 16	13/16 - 16	1 - 14	.38	.38	.49	1.06	.38	.38	.49
FF2603-10-6-10-O	5/8 - 3/8 - 5/8	1 - 14	11/16 - 16	1 - 14	1.31	1.15	1.31	1.06	.49	.26	.49
FF2603-10-10-10-O	5/8 - 5/8 - 5/8	1 - 14	1 - 14	1 - 14	1.31	1.31	1.31	1.06	.49	.49	.49
FF2603-12-12-12-O	3/4 - 3/4 - 3/4	1-3/16 - 12	1-3/16 - 12	1-3/16 - 12	1.47	1.47	1.47	1.19	.61	.61	.61
FF2603-16-16-10-O	1 - 1 - 5/8	1-7/16 - 12	1-7/16 - 12	1 - 14	1.64	1.64	1.56	1.42	.81	.81	.49
FF2603-16-16-12-O	1 - 1 - 3/4	1-7/16 - 12	1-7/16 - 12	1-3/16 - 12	1.64	1.64	1.62	1.42	.81	.81	.61
FF2603-16-16-16-O	1 - 1 - 1	1-7/16 - 12	1-7/16 - 12	1-7/16 - 12	1.64	1.64	1.64	1.44	.81	.81	.81
FF2603-20-20-20-O	1-1/4 - 1-1/4 - 1-1/4	1-11/16 - 12	1-11/16 - 12	1-11/16 - 12	1.76	1.76	1.76	1.61	1.02	1.02	1.02
FF2603-24-24-24-O	1-1/2 - 1-1/2 - 1-1/2	2 - 12	2 - 12	2 - 12	1.92	1.92	1.92	1.97	1.26	1.26	1.26

O-Ring Face Seal Adapters



FF2650 UNION CROSS

INFORMATION AVAILABLE UPON REQUEST.
CALL CUSTOMER SERVICE FOR DETAILS.

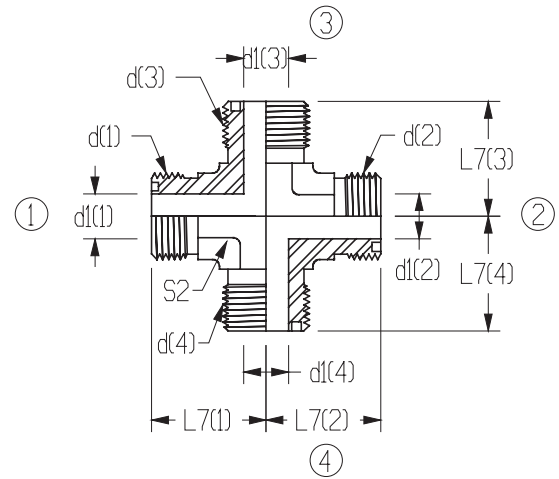

FF2700 BULKHEAD UNION

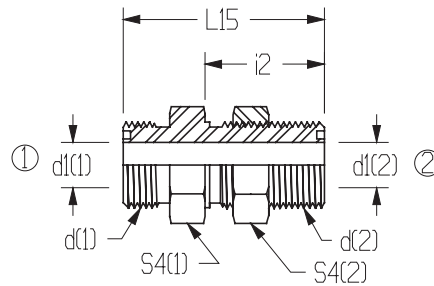

Part Number	Tube OD	d (1) UN/UNF-2A	d (2) UN/UNF-2A	L15	i2	S4 (1)	S4 (2)	d1 (1)	d1 (2)
FF2700-4-4-O	1/4 - 1/4	9/16 - 18	9/16 - 18	1.90	1.24	.81	.81	.17	.17
FF2700-6-6-O	3/8 - 3/8	11/16 - 16	11/16 - 16	2.09	1.34	1.00	1.00	.26	.26
FF2700-8-8-O	1/2 - 1/2	13/16 - 16	13/16 - 16	2.30	1.44	1.13	1.13	.38	.38
FF2700-10-10-O	5/8 - 5/8	1 - 14	1 - 14	2.62	1.60	1.31	1.31	.48	.48
FF2700-12-12-O	3/4 - 3/4	1-3/16 - 12	1-3/16 - 12	2.72	1.64	1.50	1.50	.61	.61
FF2700-16-16-O	1 - 1	1-7/16 - 12	1-7/16 - 12	2.76	1.66	1.75	1.75	.81	.81
FF2700-20-20-O	1-1/4 - 1-1/4	1-11/16 - 12	1-11/16 - 12	2.76	1.66	2.00	2.00	1.02	1.02
FF2700-24-24-O	1-1/2 - 1-1/2	2 - 12	2 - 12	2.76	1.66	2.38	2.38	1.26	1.26



O-Ring Face Seal Adapters

FF2701 90° BULKHEAD ELBOW

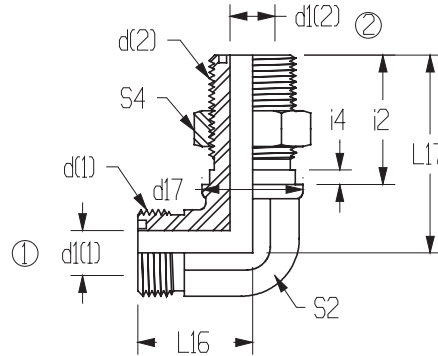

Part Number	Tube OD	d (1) UN/UNF-2A	d (2) UN/UNF-2A	L16	L17	i2	i4	d17	S4	S2	d1 (1)	d1 (2)
FF2701-4-4-O	1/4 - 1/4	9/16 - 18	9/16 - 18	.89	1.85	1.24	.06	.69	.81	.56	.17	.17
FF2701-6-6-O	3/8 - 3/8	11/16 - 16	11/16 - 16	1.02	2.05	1.30	.06	.87	1.00	.75	.26	.26
FF2701-8-8-O	1/2 - 1/2	13/16 - 16	13/16 - 16	1.14	2.18	1.37	.06	1.00	1.13	.75	.38	.38
FF2701-10-10-O	5/8 - 5/8	1 - 14	1 - 14	1.36	2.48	1.54	.06	1.19	1.31	1.06	.48	.48
FF2701-12-12-O	3/4 - 3/4	1-3/16 - 12	1-3/16 - 12	1.52	2.65	1.59	.06	1.37	1.50	1.19	.61	.61
FF2701-16-16-O	1 - 1	1-7/16 - 12	1-7/16 - 12	1.67	2.80	1.61	.06	1.62	1.75	1.44	.81	.81
FF2701-20-16-O	1-1/4 - 1	1-11/16 - 12	1-7/16 - 12	1.79	2.97	1.60	.06	1.62	1.75	1.61	1.02	.81
FF2701-20-20-O	1-1/4 - 1-1/4	1-11/16 - 12	1-11/16 - 12	1.79	2.97	1.66	.06	1.87	2.00	1.61	1.02	1.02
FF2701-24-24-O	1-1/2 - 1-1/2	2 - 12	2 - 12	1.95	3.13	1.66	.06	2.19	2.38	1.87	1.26	1.26

FF2701 90° BULKHEAD ELBOW W/LOCK NUT

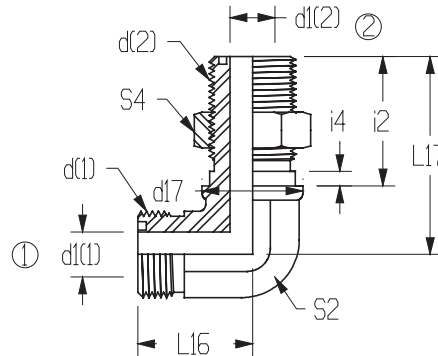

Part Number	Tube OD	d (1) UN/UNF-2A	d (2) UN/UNF-2A	L16	L17	i2	i4	d17	S4	S2	d1 (1)	d1 (2)
FF2701-4-4-LN-O	1/4 - 1/4	9/16 - 18	9/16 - 18	.89	1.85	1.24	.06	.69	.81	.56	.17	.17
FF2701-6-6-LN-O	3/8 - 3/8	11/16 - 16	11/16 - 16	1.02	2.05	1.30	.06	.87	1.00	.75	.26	.26
FF2701-8-8-LN-O	1/2 - 1/2	13/16 - 16	13/16 - 16	1.14	2.18	1.37	.06	1.00	1.13	.75	.38	.38
FF2701-10-10-LN-O	5/8 - 5/8	1 - 14	1 - 14	1.36	2.48	1.54	.06	1.19	1.31	1.06	.48	.48
FF2701-12-12-LN-O	3/4 - 3/4	1-3/16 - 12	1-3/16 - 12	1.52	2.65	1.59	.06	1.37	1.50	1.19	.61	.61
FF2701-16-16-LN-O	1 - 1	1-7/16 - 12	1-7/16 - 12	1.67	2.80	1.61	.06	1.62	1.75	1.44	.81	.81
FF2701-20-16-LN-O	1-1/4 - 1	1-11/16 - 12	1-7/16 - 12	1.79	2.97	1.60	.06	1.62	1.75	1.61	1.02	.81
FF2701-20-20-LN-O	1-1/4 - 1-1/4	1-11/16 - 12	1-11/16 - 12	1.79	2.97	1.66	.06	1.87	2.00	1.61	1.02	1.02
FF2701-24-24-LN-O	1-1/2 - 1-1/2	2 - 12	2 - 12	1.95	3.13	1.66	.06	2.19	2.38	1.87	1.26	1.26

O-Ring Face Seal Adapters



FF2702 45° BULKHEAD ELBOW

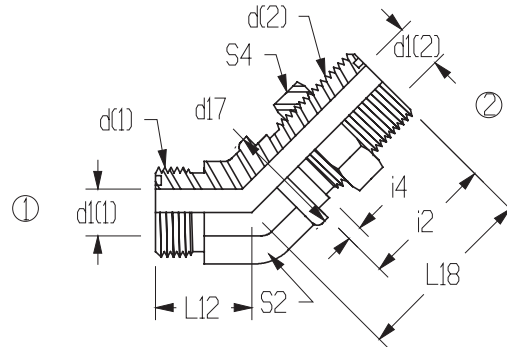

Part Number	Tube OD	d (1) UN/UNF-2A	d (2) UN/UNF-2A	L12	L18	i2	i4	d17	S4	S2	d1 (1)	d1 (2)
FF2702-4-4-O	1/4 - 1/4	9/16 - 18	9/16 - 18	.63	1.73	1.24	.06	.69	.81	.56	.17	.17
FF2702-6-6-O	3/8 - 3/8	11/16 - 16	11/16 - 16	.74	1.91	1.30	.06	.87	1.00	.75	.26	.26
FF2702-8-8-O	1/2 - 1/2	13/16 - 16	13/16 - 16	.80	2.01	1.37	.06	1.00	1.13	.75	.38	.38
FF2702-10-10-O	5/8 - 5/8	1 - 14	1 - 14	.92	2.23	1.54	.06	1.19	1.31	1.06	.48	.48
FF2702-12-12-O	3/4 - 3/4	1-3/16 - 12	1-3/16 - 12	1.02	2.39	1.59	.06	1.37	1.50	1.19	.61	.61
FF2702-16-16-O	1 - 1	1-7/16 - 12	1-7/16 - 12	1.18	2.57	1.61	.06	1.62	1.75	1.44	.81	.81
FF2702-20-20-O	1-1/4 - 1-1/4	1-11/16 - 12	1-11/16 - 12	1.26	2.64	1.66	.06	1.87	2.00	1.61	1.02	1.02
FF2702-24-24-O	1-1/2-1-1/2	2 - 12	2 - 12	1.45	2.64	1.66	.06	2.19	2.38	1.87	1.26	1.26

FF2702 45° BULKHEAD ELBOW W/LOCK NUT

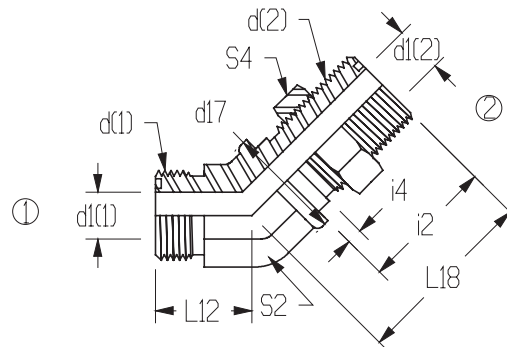

Part Number	Tube OD	d (1) UN/UNF-2A	d (2) UN/UNF-2A	L12	L18	i2	i4	d17	S4	S2	d1 (1)	d1 (2)
FF2702-4-4-LN-O	1/4 - 1/4	9/16 - 18	9/16 - 18	.63	1.73	1.24	.06	.69	.81	.56	.17	.17
FF2702-6-6-LN-O	3/8 - 3/8	11/16 - 16	11/16 - 16	.74	1.91	1.30	.06	.87	1.00	.75	.26	.26
FF2702-8-8-LN-O	1/2 - 1/2	13/16 - 16	13/16 - 16	.80	2.01	1.37	.06	1.00	1.13	.75	.38	.38
FF2702-10-10-LN-O	5/8 - 5/8	1 - 14	1 - 14	.92	2.23	1.54	.06	1.19	1.31	1.06	.48	.48
FF2702-12-12-LN-O	3/4 - 3/4	1-3/16 - 12	1-3/16 - 12	1.02	2.39	1.59	.06	1.37	1.50	1.19	.61	.61
FF2702-16-16-LN-O	1 - 1	1-7/16 - 12	1-7/16 - 12	1.18	2.57	1.61	.06	1.62	1.75	1.44	.81	.81
FF2702-20-20-LN-O	1-1/4 - 1-1/4	1-11/16 - 12	1-11/16 - 12	1.26	2.64	1.66	.06	1.87	2.00	1.61	1.02	1.02
FF2702-24-24-LN-O	1-1/2-1-1/2	2 - 12	2 - 12	1.45	2.64	1.66	.06	2.19	2.38	1.87	1.26	1.26



O-Ring Face Seal Adapters

FF2703 BULKHEAD BRANCH TEE

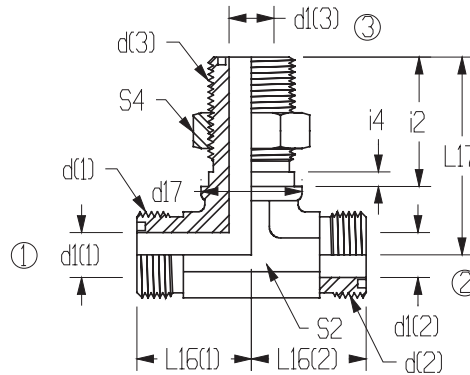

Part Number	Tube OD	d (1) UN/UNF-2A	d (2) UN/UNF-2A	d (3) UN/UNF-2A	L16 (1)	L16 (2)	L17	i2	i4	d17	S4	S2	d1 (1)	d1 (2)	d1 (3)
FF2703-4-4-4-O	1/4 - 1/4 - 1/4	9/16 - 18	9/16 - 18	9/16 - 18	.89	.89	1.85	1.24	.06	.69	.81	.56	.17	.17	.17
FF2703-6-6-6-O	3/8 - 3/8 - 3/8	11/16 - 16	11/16 - 16	11/16 - 16	1.02	1.02	2.05	1.30	.06	.87	1.00	.75	.26	.26	.26
FF2703-8-8-8-O	1/2 - 1/2 - 1/2	13/16 - 16	13/16 - 16	13/16 - 16	1.14	1.14	2.18	1.37	.06	1.00	1.13	.75	.38	.38	.38
FF2703-10-10-10-O	5/8 - 5/8 - 5/8	1 - 14	1 - 14	1 - 14	1.36	1.36	2.48	1.54	.06	1.19	1.31	1.06	.48	.48	.48
FF2703-12-12-12-O	3/4 - 3/4 - 3/4	1-3/16 - 12	1-3/16 - 12	1-3/16 - 12	1.52	1.52	2.65	1.64	.13	1.37	1.50	1.18	.61	.61	.61

FF2703 BULKHEAD BRANCH TEE W/LOCK NUT

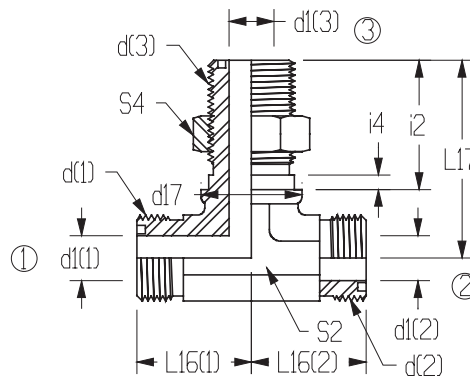

Part Number	Tube OD	d (1) UN/UNF-2A	d (2) UN/UNF-2A	d (3) UN/UNF-2A	L16 (1)	L16 (2)	L17	i2	i4	d17	S4	S2	d1 (1)	d1 (2)	d1 (3)
FF2703-4-4-4-LN-O	1/4 - 1/4 - 1/4	9/16 - 18	9/16 - 18	9/16 - 18	.89	.89	1.85	1.24	.06	.69	.81	.56	.17	.17	.17
FF2703-6-6-6-LN-O	3/8 - 3/8 - 3/8	11/16 - 16	11/16 - 16	11/16 - 16	1.02	1.02	2.05	1.30	.06	.87	1.00	.75	.26	.26	.26
FF2703-8-8-8-LN-O	1/2 - 1/2 - 1/2	13/16 - 16	13/16 - 16	13/16 - 16	1.14	1.14	2.18	1.37	.06	1.00	1.13	.75	.38	.38	.38
FF2703-10-10-10-LN-O	5/8 - 5/8 - 5/8	1 - 14	1 - 14	1 - 14	1.36	1.36	2.48	1.54	.06	1.19	1.31	1.06	.48	.48	.48
FF2703-12-12-12-LN-O	3/4 - 3/4 - 3/4	1-3/16 - 12	1-3/16 - 12	1-3/16 - 12	1.52	1.52	2.65	1.64	.13	1.37	1.50	1.18	.61	.61	.61

O-Ring Face Seal Adapters



FF2704 BULKHEAD RUN TEE

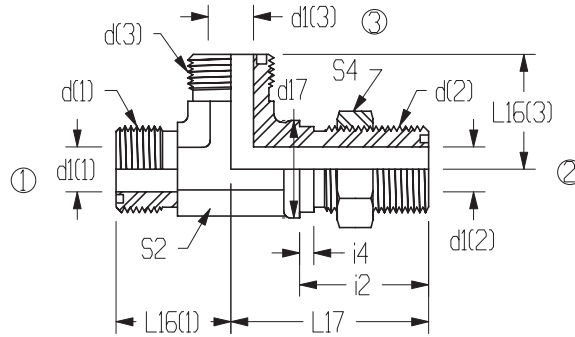

Part Number	Tube OD	d (1) UN/UNF-2A	d (2) UN/UNF-2A	d (3) UN/UNF-2A	L16 (1)	L16 (2)	L17	i2	i4	d17	S4	S2	d1 (1)	d1 (2)	d1 (3)
FF2704-4-4-4-O	1/4 - 1/4 - 1/4	9/16 - 18	9/16 - 18	9/16 - 18	.89	1.85	.89	1.24	.06	.81	.69	.56	.17	.17	.17
FF2704-6-6-6-O	3/8 - 3/8 - 3/8	11/16 - 16	11/16 - 16	11/16 - 16	1.02	2.05	1.02	1.30	.06	1.00	.87	.75	.26	.26	.26
FF2704-8-8-8-O	1/2 - 1/2 - 1/2	13/16 - 16	13/16 - 16	13/16 - 16	1.14	2.18	1.14	1.37	.06	1.13	1.00	.75	.38	.38	.38
FF2704-10-10-10-O	5/8 - 5/8 - 5/8	1 - 14	1 - 14	1 - 14	1.36	2.48	1.36	1.54	.06	1.31	1.19	1.06	.48	.48	.48
FF2704-12-12-12-O	3/4 - 3/4 - 3/4	1-3/16 - 12	1-3/16 - 12	1-3/16 - 12	1.52	2.65	1.52	1.59	.06	1.50	1.37	1.19	.61	.61	.61
FF2704-16-16-16-O	1 - 1 - 1	1-7/16 - 12	1-7/16 - 12	1-7/16 - 12	1.67	2.80	1.67	1.61	.06	1.75	1.62	1.44	.81	.81	.81

FF2704 BULKHEAD RUN TEE W/LOCK NUT

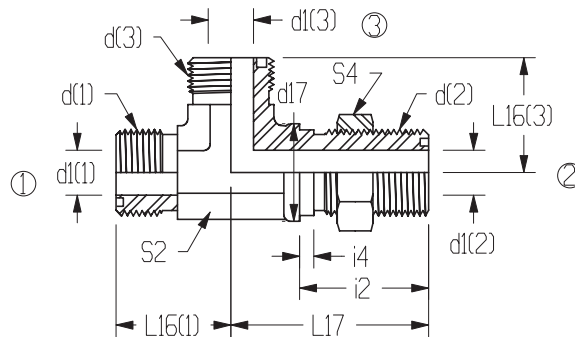

Part Number	Tube OD	d (1) UN/UNF-2A	d (2) UN/UNF-2A	d (3) UN/UNF-2A	L16 (1)	L16 (2)	L17	i2	i4	d17	S4	S2	d1 (1)	d1 (2)	d1 (3)
FF2704-4-4-4-LN-O	1/4 - 1/4 - 1/4	9/16 - 18	9/16 - 18	9/16 - 18	.89	1.85	.89	1.24	.06	.81	.69	.56	.17	.17	.17
FF2704-6-6-6-LN-O	3/8 - 3/8 - 3/8	11/16 - 16	11/16 - 16	11/16 - 16	1.02	2.05	1.02	1.30	.06	1.00	.87	.75	.26	.26	.26
FF2704-8-8-8-LN-O	1/2 - 1/2 - 1/2	13/16 - 16	13/16 - 16	13/16 - 16	1.14	2.18	1.14	1.37	.06	1.13	1.00	.75	.38	.38	.38
FF2704-10-10-10-LN-O	5/8 - 5/8 - 5/8	1 - 14	1 - 14	1 - 14	1.36	2.48	1.36	1.54	.06	1.31	1.19	1.06	.48	.48	.48
FF2704-12-12-12-LN-O	3/4 - 3/4 - 3/4	1-3/16 - 12	1-3/16 - 12	1-3/16 - 12	1.52	2.65	1.52	1.59	.06	1.50	1.37	1.19	.61	.61	.61
FF2704-16-16-16-LN-O	1 - 1 - 1	1-7/16 - 12	1-7/16 - 12	1-7/16 - 12	1.67	2.80	1.67	1.61	.06	1.75	1.62	1.44	.81	.81	.81



O-Ring Face Seal Adapters

FF6400 STRAIGHT THREAD CONNECTOR

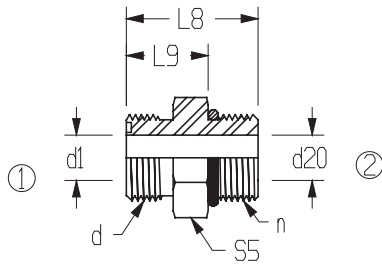

Part Number	Tube OD	d		L8	L9	S5	d1	d20
		UN/UNF-2A	n					
FF6400-4-3-O	1/4	9/16 - 18	3/8 - 24	1.07	.70	.63	.17	.13
FF6400-4-4-O	1/4	9/16 - 18	7/16 - 20	1.13	.70	.63	.17	.17
FF6400-4-5-O	1/4	9/16 - 18	1/2 - 20	1.13	.70	.63	.17	.24
FF6400-4-6-O	1/4	9/16 - 18	9/16 - 18	1.20	.73	.69	.17	.17
FF6400-4-8-O	1/4	9/16 - 18	3/4 - 16	1.32	.77	.88	.17	.17
FF6400-6-4-O	3/8	11/16 - 16	7/16 - 20	1.34	.91	.75	.26	.17
FF6400-6-6-O	3/8	11/16 - 16	9/16 - 18	1.25	.78	.75	.26	.26
FF6400-6-8-O	3/8	11/16 - 16	3/4 - 16	1.38	.83	.88	.26	.26
FF6400-6-10-O	3/8	11/16 - 16	7/8 - 14	1.53	.90	1.00	.26	.26
FF6400-6-12-O	3/8	11/16 - 16	1-1/16 - 12	1.69	.96	1.25	.26	.26
FF6400-8-6-O	1/2	13/16 - 16	9/16 - 18	1.47	1.00	.88	.38	.26
FF6400-8-8-O	1/2	13/16 - 16	3/4 - 16	1.44	.89	.88	.38	.38
FF6400-8-10-O	1/2	13/16 - 16	7/8 - 14	1.59	.96	1.00	.38	.38
FF6400-8-12-O	1/2	13/16 - 16	1-1/16 - 12	1.75	1.02	1.25	.38	.38
FF6400-8-16-O	1/2	13/16 - 16	1-5/16 - 12	1.79	1.06	1.50	.38	.84
FF6400-10-8-O	5/8	1 - 14	3/4 - 16	1.78	1.23	1.06	.48	.39
FF6400-10-10-O	5/8	1 - 14	7/8 - 14	1.70	1.07	1.06	.48	.48
FF6400-10-12-O	5/8	1 - 14	1-1/16 - 12	1.86	1.13	1.25	.48	.48
FF6400-12-8-O	3/4	1-3/16 - 12	3/4 - 16	1.91	1.36	1.25	.61	.39
FF6400-12-10-O	3/4	1-3/16 - 12	7/8 - 14	1.99	1.36	1.25	.61	.48
FF6400-12-12-O	3/4	1-3/16 - 12	1-1/16 - 12	1.92	1.19	1.25	.61	.61
FF6400-12-16-O	3/4	1-3/16 - 12	1-5/16 - 12	1.96	1.23	1.50	.61	.61
FF6400-16-10-O	1	1-7/16 - 12	7/8 - 14	2.04	1.41	1.50	.81	.49
FF6400-16-12-O	1	1-7/16 - 12	1-1/16 - 12	2.14	1.41	1.50	.81	.61
FF6400-16-16-O	1	1-7/16 - 12	1-5/16 - 12	1.99	1.26	1.50	.81	.81
FF6400-16-20-O	1	1-7/16 - 12	1-5/8 - 12	2.06	1.33	1.88	.81	.81
FF6400-20-16-O	1 1/4	1-11/16 - 12	1-5/16 - 12	2.28	1.55	1.75	1.02	.84
FF6400-20-20-O	1 1/4	1-11/16 - 12	1-5/8 - 12	2.06	1.33	1.88	1.02	1.02
FF6400-20-24-O	1 1/4	1-11/16 - 12	1-7/8 - 12	2.13	1.40	2.13	1.02	1.02
FF6400-24-20-O	1 1/2	2 - 12	1-5/8 - 12	2.35	1.62	2.13	1.26	1.08
FF6400-24-24-O	1 1/2	2 - 12	1-7/8 - 12	2.22	1.40	2.13	1.26	1.26

FF6400-L STRAIGHT THREAD CONNECTOR LONG

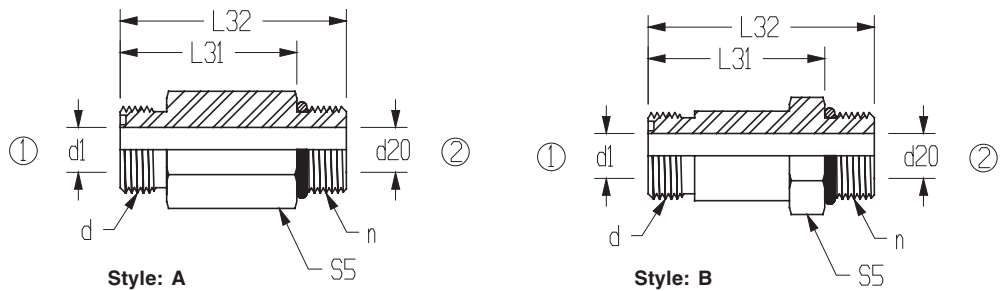

Part Number	Tube OD	d		L32	L31	S5	d1	d20
		UN/UNF-2A	n					
FF6400-L-4-4-O	1/4	9/16 - 18	7/16 - 20	2.07	1.64	.63	.17	.17
FF6400-L-6-6-O	3/8	11/16 - 18	9/16 - 18	2.27	1.80	.75	.26	.26
FF6400-L-8-8-O	1/2	13/16 - 16	3/4 - 16	2.67	2.12	.88	.38	.38
FF6400-L-10-10-O	5/8	1 - 14	7/8 - 14	3.13	2.50	1.06	.48	.48
FF6400-L-12-12-O	3/4	1-3/16 - 12	1-1/16 - 12	3.76	3.03	1.25	.61	.61
FF6400-L-16-16-O	1	1-7/16 - 12	1-5/16 - 12	4.14	3.41	1.50	.81	.81
FF6400-L-20-16-O	1-1/4	1-11/16 - 12	1-5/16 - 12	5.04	4.03	1.75	1.02	.85
FF6400-L-20-20-O	1-1/4	1-11/16 - 12	1-5/8 - 12	4.76	4.03	1.75	1.02	1.02
FF6400-L-24-24-O	1-1/2	2 - 12	1-7/8 - 12	5.26	4.53	2.13	1.26	1.26

O-Ring Face Seal Adapters



FF6402 STRAIGHT THREAD/ SWIVEL ADAPTER

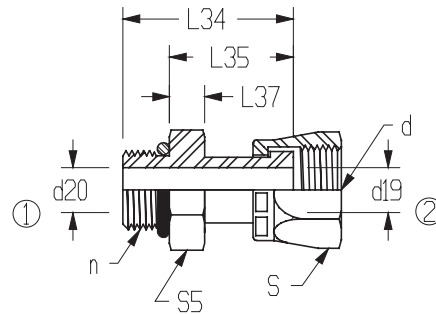

Part Number	Tube OD	D UN/UNF-2A	N UN/UNF-2A	L12	L13	L14	S3	S2	d1	d20
FF6402-4-4-O	1/4	7/16 - 20	9/16 - 18	1.46	1.03	.42	.69	.63	.17	.17
FF6402-6-6-O	3/8	9/16 - 18	11/16 - 16	1.58	1.11	.42	.81	.75	.26	.26
FF6402-8-8-O	1/2	3/4 - 16	13/16 - 16	1.94	1.39	.55	.94	.88	.38	.38
FF6402-10-10-O	5/8	7/8 - 14	1 - 14	2.21	1.49	.55	1.13	1.06	.48	.48
FF6402-12-12-O	3/4	1-1/16 - 12	13/16 - 12	2.35	1.62	.59	1.38	1.25	.61	.61
FF6402-16-16-O	1	1-5/16 - 12	1-7/16 - 12	2.66	1.93	.82	1.63	1.50	.81	.81
FF6402-20-20-O	1-1/4	1-5/8 - 12	1-11/16 - 12	2.69	1.93	.78	1.46	1.75	1.02	1.02

FF6500 90° SWIVEL ELBOW

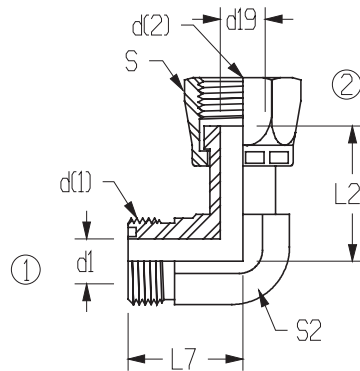

Part Number	Tube OD	d (1) UN/UNF-2A	d (2) UN/UNF-2B	L7	L52	S	S2	d1	d19
FF6500-4-4-O	1/4 - 1/4	9/16 - 18	9/16 - 18	.85	1.04	.69	.56	.17	.17
FF6500-6-6-O	3/8 - 3/8	11/16 - 16	11/16 - 16	.98	1.15	.81	.75	.26	.26
FF6500-8-8-O	1/2 - 1/2	13/16 - 16	13/16 - 16	1.10	1.49	.94	.75	.38	.36
FF6500-10-10-O	5/8 - 5/8	1 - 14	1 - 14	1.31	1.62	1.13	1.06	.48	.45
FF6500-10-16-O	5/8 - 1	1 - 14	1-7/16 - 12	1.56	2.10	1.63	1.44	.48	.78
FF6500-12-12-O	3/4 - 3/4	1-3/16 - 12	1-3/16 - 12	1.47	1.82	1.38	1.19	.61	.55
FF6500-16-16-O	1 - 1	1-7/16 - 12	1-7/16 - 12	1.64	2.10	1.63	1.44	.81	.78
FF6500-20-20-O	1-1/4 - 1	1-11/16 - 12	1-11/16 - 12	1.76	2.29	1.88	1.61	1.02	1.02
FF6500-24-24-O	1-1/2 - 1	2 - 12	2 - 12	1.92	2.41	2.25	1.97	1.26	1.26



O-Ring Face Seal Adapters

FF6502 45° SWIVEL ELBOW

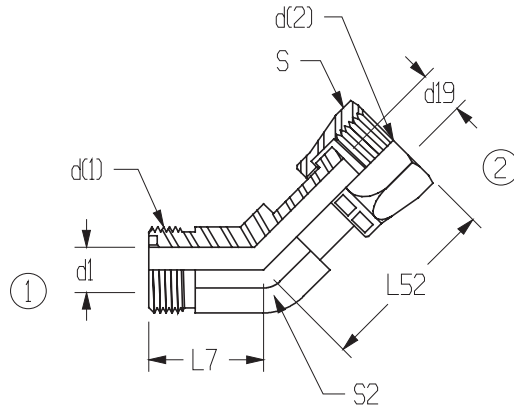

Part Number	Tube OD	d (1) UN/UNF-2A	d (2) UN/UNF-2B	L7	L52	S	S2	d1	d19
FF6502-4-4	1/4 - 1/4	9/16 - 18	9/16 - 18	.63	.99	.69	.55	.17	.17
FF6502-6-6	3/8 - 3/8	11/16 - 16	11/16 - 16	.74	1.12	.81	.75	.26	.26
FF6502-8-8	1/2 - 1/2	13/16 - 16	13/16 - 16	.80	1.49	.94	.75	.38	.36
FF6502-10-10	5/8 - 5/8	1 - 14	1 - 14	.92	1.53	1.13	1.06	.48	.45
FF6502-12-12	3/4 - 3/4	1-3/16 - 12	1-3/16 - 12	1.02	1.73	1.38	1.18	.61	.55
FF6502-16-16	1 - 1	1-7/16 - 12	1-7/16 - 12	1.18	1.87	1.63	1.42	.81	.78
FF6502-20-20	1-1/4 - 1-1/4	1-11/16 - 12	1-11/16 - 12	1.26	1.98	1.88	1.61	1.02	1.02

FF6504 MALE ORFS/ FEMALE ORFS

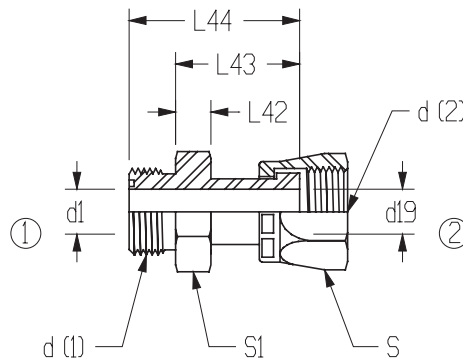

Part Number	Tube OD	d (1) UN/UNF-2A	d (2) UN/UNF-2A	L44	L43	L42	S	S1	d1	d19
FF6504-12-8-O	3/4 - 1/2	13/16 - 16	1-3/16 - 12	2.24	1.70	1.03	.94	1.13	.38	.55
FF6504-6-6-O	3/8 - 3/8	11/16 - 16	11/16 - 16	1.58	1.14	.69	.69	.69	.26	.26

O-Ring Face Seal Adapters



FF6600 SWIVEL BRANCH TEE

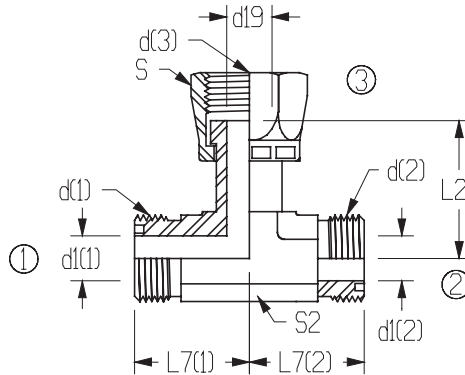

Part Number	Tube OD	d (1) UN/UNF-2A	d (2) UN/UNF-2A	d (3) UN/UNF-2B	L7 (1)	L7 (2)	L21	S	S2	d1 (1)	d1 (2)	d19
FF6600-4-4-4-O	1/4 - 1/4 - 1/4	9/16 - 18	9/16 - 18	9/16 - 18	.85	.85	1.04	.69	.56	.17	.17	.17
FF6600-6-6-6-O	3/8 - 3/8 - 3/8	11/16 - 16	11/16 - 16	11/16 - 16	.98	.98	1.15	.81	.75	.26	.26	.26
FF6600-8-8-8-O	1/2 - 1/2 - 1/2	13/16 - 16	13/16 - 16	13/16 - 16	1.10	1.10	1.49	.94	.75	.38	.38	.36
FF6600-10-10-10-O	5/8 - 5/8 - 5/8	1 - 14	1 - 14	1 - 14	1.31	1.31	1.62	1.13	1.06	.48	.48	.45
FF6600-12-12-12-O	3/4 - 3/4 - 3/4	1-3/16 - 12	1-3/16 - 12	1-3/16 - 12	1.47	1.47	1.82	1.38	1.19	.61	.61	.55
FF6600-16-16-16-O	1 - 1 - 1	1-7/16 - 12	1-7/16 - 12	1-7/16 - 12	1.64	1.64	2.10	1.63	1.44	.81	.81	.78
FF6600-20-20-20-O	1-1/4 - 1-1/4 - 1-1/4	1-11/16 - 12	1-11/16 - 12	1-11/16 - 12	1.76	1.76	2.29	1.88	1.61	1.02	1.02	1.02
FF6600-24-24-24-O	1-1/2 - 1-1/2 - 1-1/2	2 - 12	2 - 12	2 - 12	1.92	1.92	2.41	2.38	1.97	1.26	1.26	1.26

FF6602 SWIVEL RUN TEE

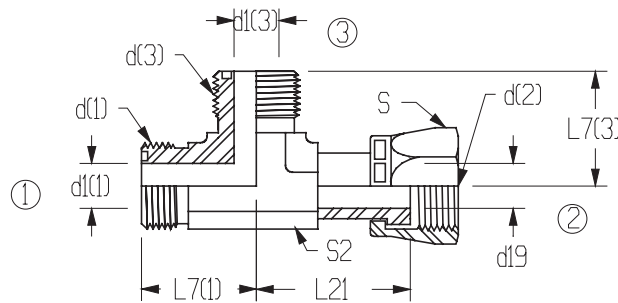

Part Number	Tube OD	d (1) UN/UNF-2A	d (2) UN/UNF-2A	d (3) UN/UNF-2B	L7 (1)	L7 (2)	L21	S	S2	d1 (1)	d1 (2)	d19
FF6602-4-4-4-O	1/4 - 1/4 - 1/4	9/16 - 18	9/16 - 18	9/16 - 18	.85	.85	1.04	.69	.56	.17	.17	.17
FF6602-6-6-6-O	3/8 - 3/8 - 3/8	11/16 - 16	11/16 - 16	11/16 - 16	.98	.98	1.15	.81	.75	.26	.26	.26
FF6602-8-8-8-O	1/2 - 1/2 - 1/2	13/16 - 16	13/16 - 16	13/16 - 16	1.10	1.10	1.49	.94	.75	.38	.38	.36
FF6602-10-10-10-O	5/8 - 5/8 - 5/8	1 - 14	1 - 14	1 - 14	1.31	1.31	1.62	1.13	1.06	.48	.48	.45
FF6602-12-12-12-O	3/4 - 3/4 - 3/4	1-3/16 - 12	1-3/16 - 12	1-3/16 - 12	1.47	1.47	1.82	1.38	1.19	.61	.61	.55
FF6602-16-16-16-O	1 - 1 - 1	1-7/16 - 12	1-7/16 - 12	1-7/16 - 12	1.64	1.64	2.10	1.63	1.44	.81	.81	.78
FF6602-20-20-20-O	1-1/4 - 1-1/4 - 1-1/4	1-11/16 - 12	1-11/16 - 12	1-11/16 - 12	1.76	1.76	2.29	1.88	1.61	1.02	1.02	1.02
FF6602-24-24-24-O	1-1/2 - 1-1/2 - 1-1/2	2 - 12	2 - 12	2 - 12	1.92	1.92	2.41	2.38	1.97	1.26	1.26	1.26



O-Ring Face Seal Adapters

FF6801 90° STRAIGHT THREAD ELBOW

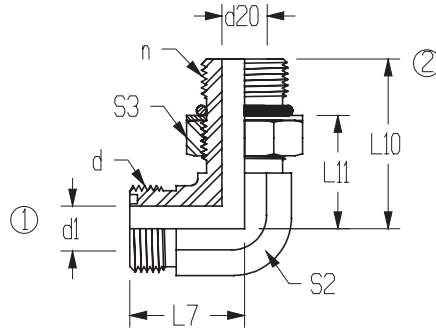

Part Number	Tube OD	d UN/UNF-2A	n UN/UNF-2A	L7	L10	L11	S3	S2	d1	d20
FF6801-4-4 NWO	1/4	9/16 - 18	7/16 - 20	.85	1.29	.86	.63	.56	.17	.17
FF6801-4-6 NWO	1/4	9/16 - 18	9/16 - 18	.92	1.45	.98	.75	.56	.17	.26
FF6801-4-8-NWO	1/4	9/16 - 18	3/4 - 16	.97	1.60	1.06	.94	.75	.17	.38
FF6801-6-4 NWO	3/8	11/16 - 16	7/16 - 20	.98	1.37	.94	.63	.75	.26	.17
FF6801-6-5-NWO	3/8	11/16 - 16	1/2 - 20	.98	1.37	.94	.69	.75	.26	.24
FF6801-6-6 NWO	3/8	11/16 - 16	9/16 - 18	.98	1.45	.98	.75	.75	.26	.26
FF6801-6-8 NWO	3/8	11/16 - 18	3/4 - 16	1.04	1.60	1.06	.94	.75	.26	.38
FF6801-6-10 NWO	3/8	11/16 - 16	7/8 - 12	1.15	1.97	1.34	1.06	.87	.26	.48
FF6801-6-12 NWO	3/8	11/16 - 16	1-1/16 - 12	1.25	2.17	1.44	1.38	1.19	.26	.61
FF6801-8-6 NWO	1/2	13/16 - 16	9/16 - 18	1.10	1.44	.96	.75	.75	.38	.26
FF6801-8-8 NWO	1/2	13/16 - 16	3/4 - 16	1.10	1.60	1.06	.94	.75	.38	.38
FF6801-8-10 NWO	1/2	13/16 - 16	7/8 - 14	1.21	1.97	1.34	1.06	.87	.38	.48
FF6801-8-12 NWO	1/2	13/16 - 16	1-1/16 - 12	1.32	2.17	1.44	1.38	1.19	.38	.61
FF6801-10-6 NWO	5/8	1 - 14	9/16 - 18	1.31	1.64	1.16	.75	1.06	.48	.26
FF6801-10-8 NWO	5/8	1 - 14	3/4 - 16	1.31	1.80	1.26	.94	1.06	.48	.38
FF6801-10-10 NWO	5/8	1 - 14	7/8 - 14	1.31	1.97	1.34	1.06	1.06	.48	.48
FF6801-12-8-NWO	3/4	1-3/16 - 12	3/4 - 16	1.47	1.84	1.30	.94	1.19	.61	.38
FF6801-12-10 NWO	3/4	1-3/16 - 12	7/8 - 14	1.47	2.01	1.38	1.06	1.19	.61	.48
FF6801-12-12 NWO	3/4	1-3/16 - 12	1-1/16 - 12	1.47	2.17	1.44	1.38	1.19	.61	.61
FF6801-12-16 NWO	3/4	1-3/16 - 12	1-5/16 - 12	1.62	2.35	1.62	1.63	1.44	.61	.81
FF6801-16-10 NWO	1	1-7/16 - 12	7/8 - 14	1.64	2.16	1.52	1.06	1.42	.81	.48
FF6801-16-12 NWO	1	1-7/16 - 12	1-1/16 - 12	1.64	2.32	1.59	1.38	1.44	.81	.61
FF6801-16-14 NWO	1	1-7/16 - 12	1-3/16 - 12	1.64	2.35	1.62	1.50	1.44	.81	.72
FF6801-16-16 NWO	1	1-7/16 - 12	1-5/16 - 12	1.64	2.35	1.62	1.63	1.44	.81	.81
FF6801-16-20 NWO	1	1-7/16 - 12	1-5/8 - 12	1.76	2.45	1.72	1.88	1.63	.81	1.02
FF6801-20-16 NWO	1-1/4	1-11/16 - 12	1-5/16 - 12	1.76	2.45	1.72	1.63	1.63	1.02	.84
FF6801-20-20 NWO	1-1/4	1-11/16 - 12	1-5/8 - 12	1.76	2.45	1.72	1.88	1.61	1.02	1.02
FF6801-20-24 NWO	1-1/4	1-11/16 - 12	1-7/8 - 12	1.92	2.59	1.86	2.13	1.88	1.02	1.26
FF6801-24-20 NWO	1-1/2	2 - 12	1-5/8 - 12	1.92	2.59	1.72	1.88	1.88	1.26	1.02
FF6801-24-24 NWO	1-1/2	2 - 12	1-7/8 - 12	1.92	2.59	1.86	2.13	1.88	1.26	1.26

FF6801-L 90° STRAIGHT THREAD ELBOW

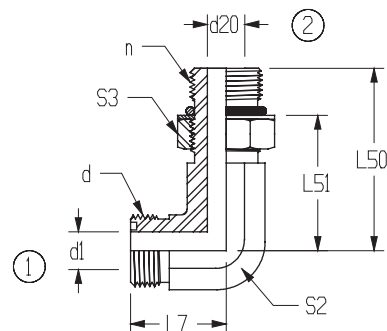

INFORMATION AVAILABLE UPON REQUEST.
CALL CUSTOMER SERVICE FOR DETAILS.

O-Ring Face Seal Adapters



FF6802 45° STRAIGHT THREAD ELBOW

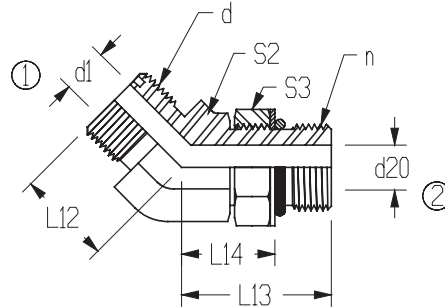

Part Number	Tube OD	D UN/UNF-2A	N UN/UNF-2A	L12	L13	L14	S3	S2	d1	d20
FF6802-4-4 NWO	1/4	9/16 - 18	7/16 - 20	.63	1.18	.75	.63	.56	.17	.17
FF6802-4-6 NWO	1/4	9/16 - 18	9/16 - 18	.68	1.30	.82	.75	.75	.17	.29
FF6802-4-8 NWO	1/4	9/16 - 18	3/4 - 16	.67	1.43	.89	.94	.75	.17	.39
FF6802-6-4 NWO	3/8	11/16 - 16	7/16 - 20	.74	1.22	.79	.63	.67	.26	.17
FF6802-6-6 NWO	3/8	11/16 - 16	9/16 - 18	.74	1.30	.82	.75	.75	.26	.26
FF6802-6-8 NWO	3/8	11/16 - 16	3/4 - 16	.74	1.43	.89	.94	.75	.26	.39
FF6802-8-6 NWO	1/2	13/16 - 16	9/16 - 18	.80	1.27	.80	.75	.75	.38	.29
FF6802-8-8 NWO	1/2	13/16 - 16	3/4 - 16	.80	1.43	.89	.94	.75	.38	.38
FF6802-8-10 NWO	1/2	13/16 - 16	7/8 - 14	.82	1.76	1.13	1.06	.94	.48	.39
FF6802-10-8 NWO	5/8	1 - 14	3/4 - 16	.92	1.59	1.05	.94	.94	.48	.38
FF6802-10-10 NWO	5/8	1 - 14	7/8 - 14	.92	1.76	1.13	1.06	1.06	.48	.48
FF6802-10-12 NWO	5/8	1 - 14	1-1/16 - 12	.96	1.97	1.24	1.38	1.06	.48	.61
FF6802-12-10 NWO	3/4	1-3/16 - 12	7/8 - 14	1.02	1.29	1.18	1.06	1.06	.61	.48
FF6802-12-12 NWO	3/4	1-3/16 - 12	1-1/16 - 12	1.02	1.97	1.24	1.38	1.19	.61	.61
FF6802-12-16 NWO	3/4	1-3/16 - 12	1-5/16 - 12	1.02	2.06	1.33	1.63	1.44	.61	.81
FF6802-16-12 NWO	1	1-7/16 - 12	1-1/16 - 12	1.18	2.03	1.30	1.38	1.42	.81	.61
FF6802-16-16 NWO	1	1-7/16 - 12	1-5/16 - 12	1.18	2.06	1.33	1.63	1.44	.81	.81
FF6802-16-20 NWO	1	1-7/16 - 12	1-5/8 - 12	1.26	2.11	1.33	1.88	1.61	.81	1.08
FF6802-20-16-NWO	1-1/4	1-11/16 - 12	1-5/16 - 12	1.27	2.11	1.33	1.63	1.44	1.02	.81
FF6802-20-20 NWO	1-1/4	1-11/16 - 12	1-5/8 - 12	1.28	2.11	1.38	1.88	1.61	1.02	1.08
FF6802-20-24 NWO	1-1/4	1-11/16 - 12	1-7/8 - 12	1.45	2.11	1.38	2.13	1.97	1.02	1.31
FF6802-24-20 NWO	1-1/2	2 - 12	1-5/8 - 12	1.58	2.11	1.38	1.88	1.61	1.26	1.08
FF6802-24-24 NWO	1-1/2	2 - 12	1-7/8 - 12	1.45	2.11	1.38	2.13	1.97	1.26	1.31

FF6803 STRAIGHT THREAD BRANCH TEE

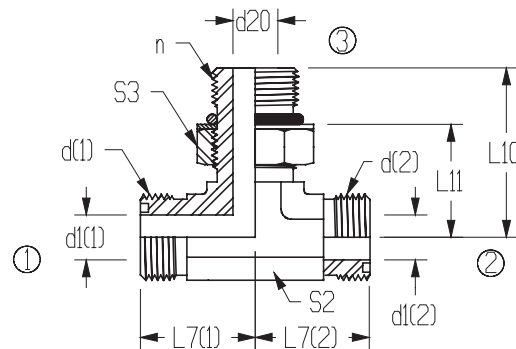

Part Number	Tube OD	d (1) UN/UNF-2A	d (2) UN/UNF-2A	N UN/UNF-2A	L7 (1)	L7 (2)	L10	L11	S3	S2	d1 (1)	d1 (2)	d20
FF6803-4-4-4 NWO	1/4 - 1/4	9/16 - 18	9/16 - 18	7/16 - 20	.85	.85	1.29	.86	.63	.56	.17	.17	.17
FF6803-6-6-6 NWO	3/8 - 3/8	11/16 - 16	11/16 - 16	9/16 - 18	.98	.98	1.45	.98	.75	.75	.26	.26	.26
FF6803-6-6-8-NWO	3/8 - 3/8	11/16 - 16	11/16 - 16	3/4 - 16	1.04	1.04	1.60	1.06	.94	.75	.26	.26	.38
FF6803-8-8-8 NWO	1/2 - 1/2	13/16 - 16	13/16 - 16	3/4 - 16	1.10	1.10	1.60	1.06	.94	.75	.38	.38	.38
FF6803-10-10-10 NWO	5/8 - 5/8	1 - 14	1 - 14	7/8 - 14	1.31	1.31	1.97	1.34	1.06	1.06	.48	.48	.48
FF6803-12-12-12 NWO	3/4 - 3/4	1-3/16 - 12	1-3/16 - 12	1-1/16 - 12	1.47	1.47	2.17	1.44	1.38	1.19	.61	.61	.61
FF6803-16-16-6-NWO	1 - 1	1-7/16 - 12	1-7/16 - 12	9/16 - 18	1.64	1.64	2.35	.98	1.63	1.48	.81	.81	.28
FF6803-16-16-16 NWO	1 - 1	1-7/16 - 12	1-7/16 - 12	1-5/16 - 12	1.64	1.64	2.35	1.62	1.63	1.48	.81	.81	.81
FF6803-20-12-16 NWO	1-1/4 - 3/4	1-11/16 - 12	1-3/16 - 12	1-5/16 - 12	1.76	1.74	2.45	1.72	1.63	1.61	1.02	.61	.85
FF6803-20-20-20 NWO	1-1/4 - 1-1/4	1-11/16 - 12	1-11/16 - 12	1-5/8 - 12	1.76	1.76	2.45	1.72	1.88	1.61	1.02	1.02	1.08
FF6803-24-24-24 NWO	1-1/2 - 1-1/2	2 - 12	2 - 12	1-7/8 - 12	1.92	1.92	2.59	1.86	2.13	1.97	1.26	1.26	1.31



O-Ring Face Seal Adapters

**FF6804
STRAIGHT
THREAD
RUN
TEE**

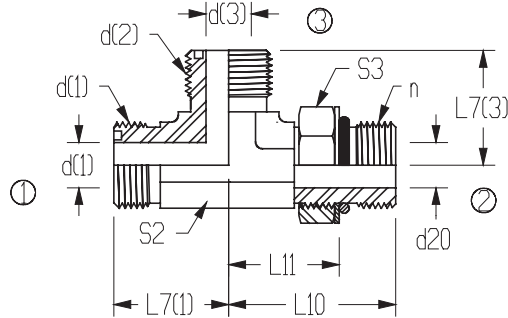

Part Number	Tube OD	d (1) UN/UNF-2A	n UN/UNF-2A	d (3) UN/UNF-2A	L7 (1)	L10	L11	L7 (3)	S3	S2	d1 (1)	d20	d1 (3)
FF6804-4-4-4 NWO	1/4 - 1/4	9/16 - 18	7/16 - 20	9/16 - 18	.85	1.29	.86	.85	.63	.56	.17	.17	.17
FF6804-4-6-4 NWO	1/4 - 3/8	9/16 - 18	9/16 - 18	9/16 - 18	.93	1.45	.98	.93	.75	.56	.17	.30	.17
FF6804-6-6-6 NWO	3/8 - 3/8	11/16 - 16	9/16 - 18	11/16 - 16	.98	1.45	.98	.98	.75	.75	.26	.26	.26
FF6804-8-8-8 NWO	1/2 - 1/2	13/16 - 16	3/4 - 16	13/16 - 16	1.10	1.60	1.06	1.10	.94	.75	.38	.38	.38
FF6804-10-10-6 NWO	5/8 - 5/8	1 - 14	7/8 - 14	11/16 - 16	1.31	1.97	1.34	1.15	1.06	1.06	.48	.48	.26
FF6804-10-10-10 NWO	5/8 - 5/8	1 - 14	7/8 - 14	1 - 14	1.31	1.97	1.34	1.31	1.06	1.06	.48	.48	.48
FF6804-12-12-12 NWO	3/4 - 3/4	1-3/16 - 12	1-1/16 - 12	1-3/16 - 12	1.47	2.17	1.44	1.47	1.38	1.19	.61	.61	.61
FF6804-16-16-16 NWO	1 - 1	1-7/16 - 12	1-5/16 - 12	1-7/16 - 12	1.64	2.35	1.62	1.64	1.63	1.44	.81	.81	.81
FF6804-20-20-20 NWO	1-1/4 - 1 1/4	1-11/16 - 12	1-5/8 - 12	1-11/16 - 12	1.76	2.45	1.72	1.76	1.88	1.63	1.02	1.02	1.02
FF6804-24-24-24 NWO	1-1/2 - 1 1/2	1-7/8 - 12	1-7/8 - 12	2 - 12	1.92	2.59	1.86	1.92	2.13	1.97	1.26	1.31	1.26

**FF6809
90°
STRAIGHT
THREAD/
FEMALE
ORFS
SWIVEL
ELBOW**

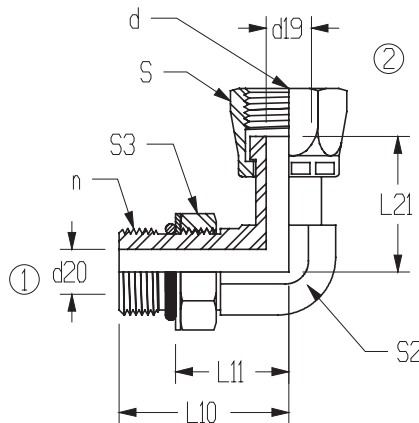

Part Number	Tube OD	d UN/UNF-2B	n UN/UNF-2A	L10	L11	L21	S	S2	S3	d19	d20
FF6809-16-16-NWO	1	1 7/16-12	1 5/16-12	2.35	1.62	2.10	1.63	1.44	1.63	.78	.81

O-Ring Face Seal Adapters



FF7403
37°
**MALE JIC/
 MALE ORFS
 ADAPTER**

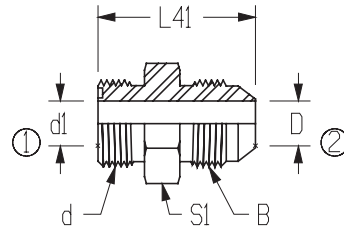

Part Number	Tube OD	d UN/UNF-2A	b UN/UNF-2A	L41	S1	d1	D
FF7403-4-4	1/4 - 1/4	9/16 - 18	7/16 - 20	1.25	.63	.17	.17
FF7403-6-6	3/8 - 3/8	11/16 - 16	9/16 - 18	1.34	.75	.26	.26
FF7403-8-8	1/2 - 1/2	13/16 - 16	3/4 - 16	1.55	.88	.38	.38
FF7403-10-10	5/8 - 5/8	1 - 14	7/8 - 14	1.83	1.06	.48	.48
FF7403-12-12	3/4 - 3/4	1-3/16 - 12	1-1/16 - 12	2.05	1.25	.61	.61
FF7403-16-16	1 - 1	1-7/16 - 12	1-5/16 - 12	2.16	1.50	.81	.81

FF7504
37°
**MALE JIC/
 MALE ORFS
 SWIVEL
 ADAPTER**

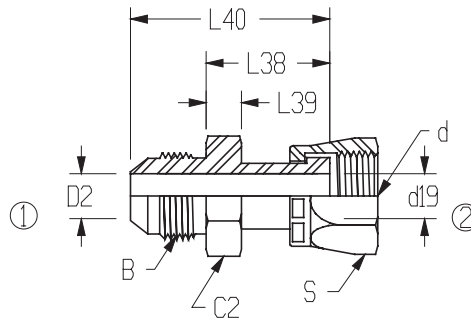

Part Number	Tube OD	D UN/UNF-2A	N UN/UNF-2A	L12	L13	L14	S3	S2	d1	d20
FF7504-4-4	1/4 - 1/4	9/16 - 18	7/16 - 20	1.50	.95	.34	.56	.40	.17	.17
FF7504-6-6	3/8 - 3/8	11/16 - 16	9/16 - 18	1.61	1.05	.39	.69	.52	.26	.26
FF7504-8-8	1/2 - 1/2	13/16 - 16	3/4 - 16	1.90	1.24	.40	.88	.64	.36	.36
FF7504-10-10	5/8 - 5/8	1 - 14	7/8 - 14	2.20	1.44	.50	.94	.82	.45	.45
FF7504-12-12	3/4 - 3/4	1-3/16 - 12	1-1/16 - 12	2.50	1.64	.61	1.13	.98	.55	.55
FF7504-16-16	1 - 1	1-7/16 - 12	1-5/16 - 12	2.66	1.75	.64	1.38	1.16	.78	.78
FF7504-20-20	1-1/4 - 1-1/4	1-11/16 - 12	1-5/8 - 12	2.80	1.84	.69	1.69	1.46	1.02	1.02



Metric and BSP Adapters

Part Number	Description
-------------	-------------

JB 4-2	4 JIC 2 BSPP
JB 4-4	4 JIC 4 BSPP
JB 4-6	4 JIC 6 BSPP
JB 6-4	6 JIC 4 BSPP
JB 6-6	6 JIC 6 BSPP
JB 6-8	6 JIC 8 BSPP
JB 8-6	8 JIC 6 BSPP
JB 8-8	8 JIC 8 BSPP
JB 10-8	10 JIC 8 BSPP
JB 12-12	12 JIC 12 BSPP
JB 16-16	16 JIC 16 BSPP

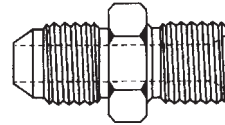

JB 4-2-K	4 JIC 2 BSPT
JB 4-4-K	4 JIC 4 BSPT
JB 6-4-K	6 JIC 4 BSPT
JB 6-6-K	6 JIC 6 BSPT
JB 8-6-K	8 JIC 6 BSPT
JB 8-8-K	8 JIC 8 BSPT
JB 12-12-K	12 JIC 12 BSPT

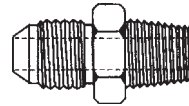

JB 4-4-90	4 JIC 4 BSPP 90
JB 6-4-90	6 JIC 4 BSPP 90
JB 6-6-90	6 JIC 6 BSPP 90
JB 8-8-90	8 JIC 8 BSPP 90
JB 12-12-90	12 JIC 12 BSPP 9

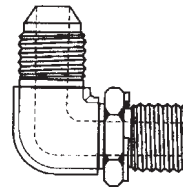

JB 4-4-90-K	4 JIC 4 BSPT 90
JB 6-4-90-K	6 JIC 4 BSPT 90
JB 6-6-90-K	6 JIC 6 BSPT 90

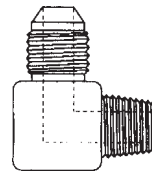

JM 4-10	4 JIC M10 X 1
JM 4-12	4 JIC M12 X 1.5
JM 4-14	4 JIC M14 X 1.5
JM 6-14	6 JIC M14 X 1.5
JM 6-16	6 JIC M16 X 1.5
JM 8-16	8 JIC M16 X 1.5
JM 8-18	8 JIC M18 X 1.5
JM 8-22	8 JIC M22 X 1.5
JM 10-20	10 JIC M20 X 1.5
JM 10-22	10 JIC M22 X 1.5
JM 12-22	12 JIC M22 X 1.5
JM 12-27	12 JIC M27 X 2

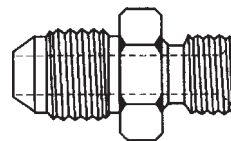

Metric and BSP Adapters



Part Number	Description
-------------	-------------

JM 4-10-90 4 JIC M10 X 1 90
 JM 4-14-90 4 JIC M14 X 1.5 90
 JM 6-14 90 6 JIC M14 X 1.5 90
 JM 8-18-90 8 JIC M18 X 1.5 90
 JM 8-22-90 8 JIC M22 X 1.5 90
 JM 10-20-90 10 JIC M20 X 1.5 90
 JM 10-22-90 10 JIC M22 X 1.5 90
 JM 12-22-90 12 JIC M22 X 1.5 90

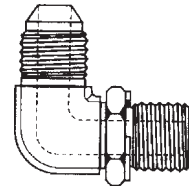

JM 6-8-TL 6 JIC M14 X 1.5L TUBE SEAT
 JM 8-12-TL 8 JIC M18 X 1.5L TUBE SEAT

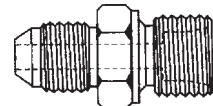

JT 4-8 4 JIC 8 MM STANDPIPE
 JT 8-12 8 JIC 12 MM STANDPIPE

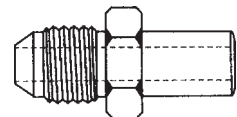

PB 2-2 2 NPT FEM 2 BSPP
 PB 4-4 4 NPT FEM 4 BSPP
 PB 6-6 6 NPT FEM 6 BSPP
 PB 8-8 8 NPT FEM 8 BSPP
 PB 12-12 12 NPT FEM 12 BSPP
 PB 16-16 16 NPT FEM 16 BSPP

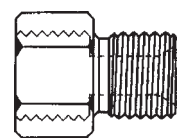

PB 2-2-K 2 NPT FEM 2 BSPT
 PB 4-4-K 4 NPT FEM 4 BSPT
 PB 6-6-K 6 NPT FEM 6 BSPT

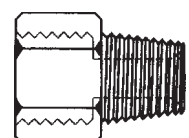

PM 2-10 2 NPT FEM M10 X 1
 PM 4-12 4 NPT FEM M12 X 1.5
 PM 4-14 4 NPT FEM M14 X 1.5
 PM 6-16 6 NPT FEM M16 X 1.5
 PM 6-18 6 NPT FEM M18 X 1.5
 PM 8-16 8 NPT FEM M16 X 1.5
 PM 8-18 8 NPT FEM M18 X 1.5
 PM 8-22 8 NPT FEM M22 X 1.5
 PM 12-27 12 NPT FEM M27 X 2
 PM 16-33 16 NPT FEM M33 X 2

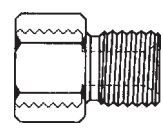

1B 4-4 4 BSP 4 BSP MALE UNION
 1B 6-6 6 BSP 6 BSP MALE UNION
 1B 8-8 8 BSP 8 BSP MALE UNION
 1B 12-12 12 BSP 12 BSP MALE UNION
 1B 16-16 16 BSP 16 BSP MALE UNION

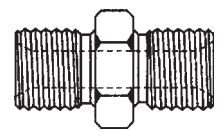



Metric and BSP Adapters

Part Number	Description
-------------	-------------

1 BT 4-4 4 BSP 4 BSPT MALE
 1 BT 6-6 6 BSP 6 BSPT MALE
 1 BT 8-8 8 BSP 8 BSPT MALE
 1BT 12-12 12 BSP 12 BSPT MALE
 1BT 16-16 16 BSP 16 BSPT MALE

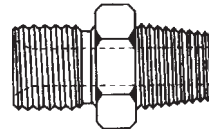

1BO 4-4 4 BSP 4 ORB
 1BO 6-6 6 BSP 6 ORB
 1BO 8-8 8 BSP 8 ORB
 1BO 12-12 12 BSP 12 ORB
 1BO 16-16 16 BSP 16 ORB

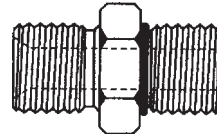

1BN 4-4 4 BSP 4 NPT MALE
 1BN 6-6 6 BSP 6 NPT MALE
 1BN 8-8 8 BSP 8 NPT MALE
 1BN 12-12 12 BSP 12 NPT MALE
 1BN 16-16 16 BSP 16 NPT MALE

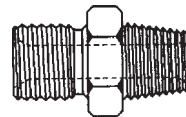

2B 4-4 4 BSP 4 BSP SW FEM
 2B 6-6 6 BSP 6 BSP SW FEM
 2B 8-8 8 BSP 8 BSP SW FEM
 2B 12-12 12 BSP 12 BSP SW FEM
 2B 16-16 16 BSP 16 BSP SW FEM

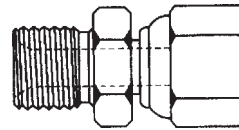

2BJ 4-4 4 BSP 4 JIC SW FEM
 2BJ 6-6 6 BSP 6 JIC SW FEM
 2BJ 8-8 8 BSP 8 JIC SW FEM
 2BJ 12-12 12 BSP 12 JIC SW FEM
 2BJ 16-16 16 BSP 16 JIC SW FEM

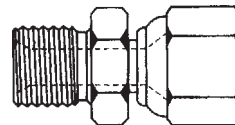

2NB 4-4 4 NPT 4 BSP SW FEM
 2NB 6-6 6 NPT 6 BSP SW FEM
 2NB 8-8 8 NPT 8 BSP SW FEM
 2NB 12-12 12 NPT 12 BSP SW FEM
 2NB 16-16 16 NPT 16 BSP SW FEM

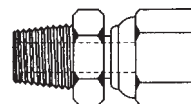

3B 4-4 4 BSP 4 BSP SW FEM UNION
 3B 6-6 6 BSP 6 BSP SW FEM UNION
 3B 8-8 8 BSP 8 BSP SW FEM UNION
 3B 12-12 12 BSP 12 BSP SW FEM UNION
 3B 16-16 16 BSP 16 BSP SW FEM UNION

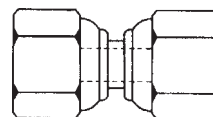

3BJ 4-4 4 BSP 4 JIC SW FEM
 3BJ 6-6 6 BSP 6 JIC SW FEM
 3BJ 8-8 8 BSP 8 JIC SW FEM
 3BJ 12-12 12 BSP 12 JIC SW FEM
 3BJ 16-16 16 BSP 16 JIC SW FEM

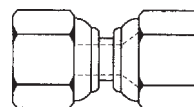

Metric and BSP Adapters



Part Number	Description
-------------	-------------

4B-4P 4 BSP PLUG
 4B-6P 6 BSP PLUG
 4B-8P 8 BSP PLUG
 4B-12P 12 BSP PLUG
 4B-16P 16 BSP PLUG

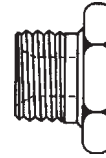

4T-4P 4 BSPT ... PLUG
 4T-6P 6 BSPT ... PLUG
 4T-8P 8 BSPT ... PLUG
 4T-12P 12 BSPT ... PLUG
 4T-16P 16 BSPT ... PLUG

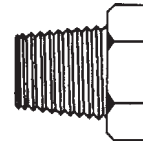

6B 4-4 4 BSP BULKHEAD
 6B 6-6 6 BSP BULKHEAD
 6B 8-8 8 BSP BULKHEAD
 6B 12-12 12 BSP BULKHEAD
 6B 16-16 16 BSP BULKHEAD

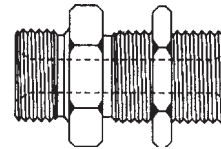

LNB 4-4 4 LOCKNUT
 LNB 6-6 6 LOCKNUT
 LNB 8-8 8 LOCKNUT
 LNB 12-12 12 LOCKNUT
 LNB 16-16 16 LOCKNUT



CB 4-4 4 BSP BLANKING CAP
 CB 6-6 6 BSP BLANKING CAP
 CB 8-8 8 BSP BLANKING CAP
 CB 12-12 12 BSP BLANKING CAP
 CB 16-16 16 BSP BLANKING CAP

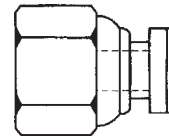

2 JB 4-4 4 JIC 4 BSP SW FEM
 2 JB 6-6 6 JIC 6 BSP SW FEM
 2 JB 8-8 8 JIC 8 BSP SW FEM
 2 JB 12-12 12 JIC 12 BSP SW FEM
 2 JB16-16 16 JIC 16 BSP SW FEM

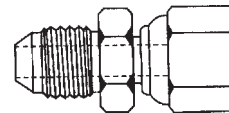

400 021 4490 4 BSP BONDED SEAL
 400 023 4490 6 BSP BONDED SEAL
 400 025 4490 8 BSP BONDED SEAL
 400 027 4490 12 BSP BONDED SEAL
 400 030 4490 16 BSP BONDED SEAL





Metal Hose Weld Fittings

JIC 37° SWIVEL FEMALE WELD FITTINGS FOR METAL HOSE

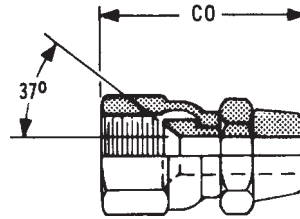

Carbon Steel

Part Number	Metal Hose I.D.	Female Thread	Body Hex	Overall Length	Inside Diameter	Taper Length	Taper O.D. At End
04-604	1/4	7/16 - 20	5/8	1.325	.156	7/16	1/2
06-606	3/8	9/16 - 18	11/16	1.390	.296	7/16	5/8
08-608	1/2	3/4 - 16	13/16	1.525	.406	7/16	11/16
08-610	1/2	7/8 - 14	13/16	1.625	.406	7/16	11/16
12-612	3/4	1-1/16 - 12	1-1/16	1.740	.625	7/16	15/16
16-616	1	1-5/16 - 12	1-3/8	1.925	.844	7/16	1-3/16
20-620	1-1/4	1-5/8 - 12	1-3/4	2.050	1.062	7/16	1-1/2
24-624	1-1/2	1-7/8 - 12	2	2.250	1.312	7/16	1-3/4
32-632	2	2-1/2 - 12	2-1/2	2.565	1.656	7/16	2-1/4

Stainless Steel Type 303

Part Number	Metal Hose I.D.	Female Thread	Body Hex	Overall Length	Inside Diameter	Taper Length	Taper O.D. At End
04-SS-604	1/4	7/16 - 20	5/8	1.325	.156	7/16	1/2
06-SS-606	3/8	9/16 - 18	11/16	1.390	.296	7/16	5/8
08-SS-608	1/2	3/4 - 16	13/16	1.525	.406	7/16	11/16
08-SS-610	1/2	7/8 - 14	13/16	1.625	.406	7/16	11/16
12-SS-612	3/4	1-1/16 - 12	1-1/16	1.740	.625	7/16	15/16
16-SS-616	1	1-5/16 - 12	1-3/8	1.925	.844	7/16	1-3/16
20-SS-620	1-1/4	1-5/8 - 12	1-3/4	2.050	1.062	7/16	1-1/2
24-SS-624	1-1/2	1-7/8 - 12	2	2.250	1.312	7/16	1-3/4

Stainless Steel Type 316

Part Number	Metal Hose I.D.	Female Thread	Body Hex	Overall Length	Inside Diameter	Taper Length	Taper O.D. At End
04-S16-604	1/4	7/16 - 20	5/8	1.325	.156	7/16	1/2
06-S16-606	3/8	9/16 - 18	11/16	1.390	.296	7/16	5/8
08-S16-608	1/2	3/4 - 16	13/16	1.525	.406	7/16	11/16
08-S16-610	1/2	7/8 - 14	13/16	1.625	.406	7/16	11/16
12-S16-612	3/4	1-1/16 - 12	1-1/16	1.740	.625	7/16	15/16
16-S16-616	1	1-5/16 - 12	1-3/8	1.925	.844	7/16	1-3/16
20-S16-620	1-1/4	1-5/8 - 12	1-3/4	2.050	1.062	7/16	1-1/2
24-S16-624	1-1/2	1-7/8 - 12	2	2.250	1.312	7/16	1-3/4
32-S16-632	2	2-1/2 - 12	2-1/2	2.565	1.656	7/16	2-1/4

Metal Hose Weld Fittings



NPTF SOLID MALE WELD FITTINGS FOR METAL HOSE

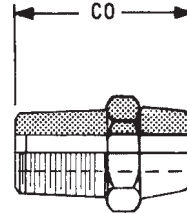

Carbon Steel

Part Number	Metal Hose I.D.	NPTF Male Thread	Body Hex	Overall Length	Inside Diameter	Taper Length	Taper O.D. At End
04-104	1/4	1/4 - 18	5/8	1.280	.250	7/16	1/2
06-106	3/8	3/8 - 18	11/16	1.280	.375	7/16	5/8
08-108	1/2	1/2 - 14	7/8	1.500	.468	7/16	11/16
12-112	3/4	3/4 - 14	1-1/16	1.562	.656	7/16	15/16
16-116	1	1 - 11-1/2	1-3/8	1.750	.890	7/16	1-3/16
20-120	1-1/4	1-1/4 - 11-1/2	1-3/4	1.781	1.250	7/16	1-1/2
24-124	1-1/2	1-1/2 - 11-1/2	2	1.937	1.312	7/16	1-3/4
32-132	2	2 - 11-1/2	2-1/2	1.968	1.687	7/16	2-1/4

Stainless Steel Type 303

Part Number	Metal Hose I.D.	NPTF Male Thread	Body Hex	Overall Length	Inside Diameter	Taper Length	Taper O.D. At End
04-SS-104	1/4	1/4 - 18	5/8	1.280	.250	7/16	1/2
06-SS-106	3/8	3/8 - 18	11/16	1.280	.375	7/16	5/8
08-SS-108	1/2	1/2 - 14	7/8	1.500	.468	7/16	11/16
12-SS-112	3/4	3/4 - 14	1-1/16	1.562	.656	7/16	15/16
16-SS-116	1	1 - 11-1/2	1-3/8	1.750	.890	7/16	1-3/16
20-SS-120	1-1/4	1-1/4 - 11-1/2	1-3/4	1.781	1.250	7/16	1-1/2
24-SS-124	1-1/2	1-1/2 - 11-1/2	2	1.937	1.312	7/16	1-3/4
32-SS-132	2	2 - 11-1/2	2-1/2	1.968	1.687	7/16	2-1/4

Stainless Steel Type 316

Part Number	Metal Hose I.D.	NPTF Male Thread	Body Hex	Overall Length	Inside Diameter	Taper Length	Taper O.D. At End
04-S16-104	1/4	1/4 - 18	5/8	1.280	.250	7/16	1/2
06-S16-106	3/8	3/8 - 18	11/16	1.280	.375	7/16	5/8
08-S16-108	1/2	1/2 - 14	7/8	1.500	.468	7/16	11/16
12-S16-112	3/4	3/4 - 14	1-1/16	1.562	.656	7/16	15/16
16-S16-116	1	1 - 11-1/2	1-3/8	1.750	.890	7/16	1-3/16
20-S16-120	1-1/4	1-1/4 - 11-1/2	1-3/4	1.781	1.250	7/16	1-1/2
24-S16-124	1-1/2	1-1/2 - 11-1/2	2	1.937	1.312	7/16	1-3/4
32-S16-132	2	2 - 11-1/2	2-1/2	1.968	1.687	7/16	2-1/4